

Aluminium, Cast Iron & Steel Rainwater Systems

Technical Brochure

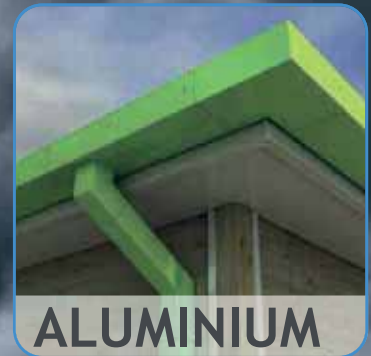

Featuring Harmer LCC Soil & Waste Systems

Maintaining a Flow of Information

www.alumascrainwater.co.uk

The Alumasc Rainwater website provides a wealth of information on all aspects of rainwater solutions, including gutters, downpipes and associated fittings. Also included are FAQs, file downloads for NBS specification clauses, COSHH information and a CAD library.



Drainage Design Calculator

Architects and building service engineers can now design and quantify all their Rainwater Drainage requirements using Alumasc's dedicated design software.

Key Features

- Eaves drainage gutter sizing and pipe calculator for cast and contemporary gutter types
- Category 2 and 3 Flat Roof Drainage Calculator linked to local rainfall data
- Hyperlinks to product literature, DWF files and application specific NBS Specification Clauses



Technical Support

Alumasc Rainwater products are backed-up by comprehensive technical literature and by hands-on project support starting with technical and design advice, and extending through site installation to recommendation of appropriate maintenance regimes. Implementation is led by the Alumasc Rainwater Manager appointed to the project.

Contents

Introduction

■ Alumasc - An Introduction	4
■ Quality and Sustainability	5
■ Alumasc Manufacturing and Support Services	6
■ Benefits of Aluminium	7
■ Benefits of Cast Iron and Steel	8
■ Aluminium Rainwater Systems - Overview	9
■ Aluminium Rainwater Systems - Overview of Finishes	10
■ Cast Iron Rainwater/Soil/Waste Systems - Overview	11
■ Cast Iron Rainwater/Soil/Waste Systems - Overview of Finishes	12
■ Steel Rainwater System - Overview and Finishes	13
■ Alumasc Rainwater Systems - Product Selector	14
■ Alumasc Rainwater Systems - Project Gallery	18

The Traditional Aluminium Range

■ Introduction	20
■ Heritage - Product Summary	22
■ Heritage - Cast Aluminium Gutter and Pipe Systems	24

The Contemporary Aluminium Range

■ Introduction	44
■ Aqualine - Product Summary	46
■ Aqualine - Extruded Aluminium Gutter Systems	48
■ AX - Product Summary	58
■ AX - Extruded Aluminium Gutter Systems	60
■ GX - Product Summary	66
■ GX - Pressed Aluminium Gutter Systems	68
■ Flushjoint - Product Summary	74
■ Flushjoint - Aluminium Downpipe System	76
■ Swaged - Product Summary	84
■ Swaged - Aluminium Downpipe System	86
■ Guardian - Product Summary	90
■ Guardian - Aluminium Security Pipe System	92

Aluminium Range Installation Procedures

■ Introduction	96
■ Heritage Gutters	98
■ Heritage Rainwater Pipes	99
■ Aqualine Gutter and Bracket Preparation	100
■ Aqualine Half Round, Deep Run and Modern Gutters	102
■ Aqualine Moulded and Box Gutters	103
■ AX Moulded Gutters, Direct Fix	104
■ AX HalfRound and Moulded Gutters, Bracket Fix	105
■ GX Gutter Preparation	106
■ GX Joggle Gutter	107
■ GX Smooth Gutter	108
■ GX Moulded Gutter	109
■ Flushjoint Rainwater Pipes	110
■ Swaged Rainwater Pipes	111
■ Guardian Rainwater Pipes	112

Aluminium Range Supplementary Information

■ Introduction	114
■ Non-Standard Items	115
■ Sundry Items	116
■ Rainwater System Design	117
■ Gutter Flow Rates	118
■ NBS Specification	119
■ General Specification Advice	120
■ Skyline System	121
■ Skyline Fascias and Soffits	122
■ Skyline Coping System	123

The Cast Iron Standard Range

■ Introduction	124
■ Standard Range Product Summary	126
■ Apex Heritage Gutter and Pipe Systems	128

The Cast Iron Made To Order Range

■ Introduction	150
■ Apex Heritage - Gutters	152
■ Apex Heritage - Rainwater Heads	153
■ Apex Heritage - Pipes and Holderbats	155

Cast Iron Range Installation Procedures

■ Introduction	156
■ Apex Heritage Gutters	158
■ Apex Heritage Rainwater Pipes	159

Cast Iron Range Supplementary Information

■ Introduction	160
■ Accessories	161
■ Rainwater System Design	162
■ Gutter Flow Rates	163
■ NBS Specification	164
■ General Specification Advice	165

Harmer LCC Cast Iron Soil & Waste Systems

■ Introduction	166
■ Product Summary	167
■ LCC Pipes	169
■ LCC Fittings	171

Harmer LCC Cast Iron Supplementary Information

■ Introduction	180
■ Installation	181
■ NBS Specification	182
■ Imperial/Metric Conversion Chart	183

The Steel Range

■ Introduction	184
■ Product Summary	185
■ Gutters and Fittings	187
■ Gutter Fittings, Pipes and Fittings	188
■ Pipes and Fittings	189

Steel Range Supplementary Information

■ Introduction	190
■ Installation - Gutters	191
■ Installation - Rainwater Pipes	192
■ Rainwater System Design	193
■ NBS Specification	194

Alumasc Premium Products - All Brands

	195
--	-----

Alumasc - An Introduction

The Alumasc Group plc has over 600 employees, generating a turnover of around £100 million. The aim is to focus on high quality, environmentally responsible building products within the construction arena in order to deliver first class customer service, technical support, long-term solutions and lasting relationships.

About Alumasc

Alumasc is a UK-based supplier of premium building products. The majority of the group's business is in the area of sustainable building products which enable customers to manage energy and water use in the built environment.

All Alumasc businesses have strong UK market positions within their own individual market niches and several are market leaders. Alumasc sustains this strong strategic positioning by offering customers quality products, service and trust. For certain brands, Alumasc is seeking to leverage UK successes in international markets, with particular focus in America, the Middle and Far East, and Europe.

Alumasc fosters an entrepreneurial, achievement orientated culture whereby businesses are encouraged to innovate and respond quickly to local market needs within a cohesive group strategic and management framework. Alumasc businesses also benefit from the group's financial strength.



Alumasc Water Management Solutions (AWMS) is the new name in the industry for proven water management. It's a new joined-up brand that harnesses the expertise of four trusted brands in water management:



Alumasc has been promoting the efficient use, retention, recycling and disposal of water within the built environment for over 80 years. Now, it combines the knowledge and unique benefits of these four brands to provide one simple solution in water management.

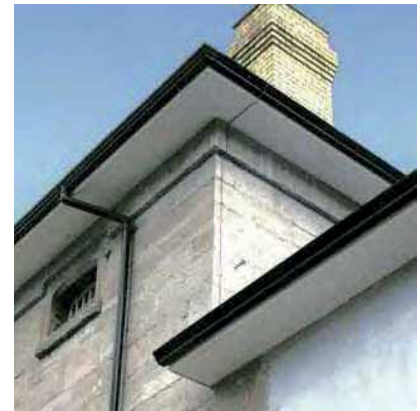

Services and Support

Alumasc leads the way in the field of construction product and system manufacture and the delivery of proven solutions. This success is founded on four key areas:

Premium Products

A constantly evolving range of quality proven, world class products and systems, fully accredited to UK, European and North American Standards.

Technical Support

Comprehensive data for specification and use of all products and systems is available in published form, and on the company website. This is backed up by proactive support on a project basis, led by specialist area managers and using the latest CAD and calculation technology.

Approved Stockists

Delivery of Alumasc products is controlled through a network of approved suppliers. This allows close control over all matters to ensure first class customer service.

Warranties

All Alumasc products come with a company backed assurance as to their quality, life expectancy and suitability for purpose ensuring specifiers and end users long-term peace of mind.



Quality and Sustainability

In addition to complying with environmental legislation, Alumasc is committed to developing its own measures to limit the adverse effects of its activities on the environment. To this end, Alumasc operates an environmental policy that fully integrates all aspects of company activities.



Quality

ISO 9001: 2008

Alumasc operates a quality management system which is independently audited to ISO 9001: 2008. The ISO 9001 framework governs the management of many aspects of Alumasc support services, manufacturing and transport operations. Alumasc extends quality management to its network of approved installers for single source accountability and peace of mind.



Sustainability

Alumasc actively pursues sustainability in the full range of products it offers and, with its partners and its suppliers, is committed to putting consideration for the built and wider environment at the core of all aspects of current business and future development.

ISO 14001: 2004

Alumasc's manufacturing sites at St Helens, Merseyside and at Burton Latimer, Northamptonshire are audited to the ISO 14001:2004 Environmental Management Standard. Alumasc is committed to achieving improvements across all of its operating sites, not only as a good neighbour to the surroundings of manufacturing plants, but in the responsible sourcing of raw materials and monitoring of the impact on the environment as a whole.



BREEAM Standards

BREEAM points, as a framework for analysis and scoring, allow easy comparison of the relative merits of different construction types and also comparisons between different construction product groups. The BREEAM points system promotes the use of materials with a proven sustainable message and allows designers to differentiate between products with true ecological credentials and those not achieving the benchmark.

Indicative ratings for building materials given in the BRE Green Guide to Specification also allows designers to choose those products or construction methods that will be most beneficial in contributing to a high BREEAM points score.

Aluminium rainwater goods and fascia soffit systems are part of the range of high scoring Alumasc solutions. Promotion of these responsibly sourced materials brings clarity to the specification process thus achieving the desired effect of minimising the environmental impact of the construction process.

Testing and Certification

Applicable Standards

BS EN 12056-3

Gravity drainage systems inside buildings, Part 3 Roof drainage layout and calculation.

BS EN 8530 (Formerly BS 2997)

Specification for traditional-style half round, beaded half round, victorian ogee and moulded aluminium rainwater systems.

BS EN 755

Aluminium and aluminium alloys - Extruded rod/bar, tube and profiles.

BS EN 1706:2010

Aluminium and aluminium alloys - Castings - Chemical composition and mechanical properties.

BS EN 1559

Founding - Technical conditions of delivery.

BS EN 1462:2004

Brackets for eaves gutters - Requirements and testing.

BS EN 12206-1:2004

Paints and varnishes - Coating of aluminium and aluminium alloys for architectural purposes.

BS 460: 2002

Cast iron rainwater goods. Specification.

BS 437: 2008

Specification for cast iron drain pipes, fittings and their joints for socketed and socketless systems.

British Board of Agrément

Certificate No. 86/1671

Alumasc Rainwater Systems.

RIBA Assessed CPD Seminar

Rainwater Disposal from Pitched Roofs.



Alumasc Manufacturing and Support Services

Alumasc is one of the UK's leading manufacturers of aluminium and cast iron products for the construction industry. Our expertise in aluminium casting, extrusion and fabrication, as well as iron castings, stems from a proven track record accumulated over 60 years, enabling the provision of unrivalled technical support for designers, specifiers and contractors.

Manufacturing

Alumasc's UK casting and fabrication facilities employ both traditional and cutting edge production methods. Alumasc aluminium rainwater goods are manufactured and independently assessed at the company's Burton Latimer site under the ISO 14001:2004 Environmental Management Standard. This not only ensures that upstream production processes have been monitored for their environmental impact, but that due consideration is taken for all aspects of packaging, transport and disposal, in order to deliver as sustainable a rainwater product as practicable.

Cast iron and steel rainwater goods are manufactured in dedicated factories abroad.

Performance

Alumasc rainwater solutions are designed to give optimum performance over their lifespan. In every aspect of material choice or detailing decision the aim is to produce premium, fit for purpose products and systems. This ethos has resulted in Alumasc being associated with innovative projects that have led the way in construction performance, stood the test of time and demonstrated good design.

Materials

Alumasc offer a variety of aluminium finishes to the specifier. Whether you are seeking to replicate a period cast iron or contemporary appearance, Alumasc has the solution. Traditional cast aluminium gutter profiles and complementary downpipes can be finished to replicate cast iron to special order - ideal for period refurbishment or where a traditional design is required.

Alumasc's contemporary aluminium rainwater ranges include dry joint extruded and wet joint folded gutter profiles, which can be used in combination with various downpipes to fulfil different functional requirements (eg, high security) and for different visual effects to suit the building context. Products can be supplied in a plain mill finish or in Alumasc's Raincote range of polyester powder coated finishes.

Alumasc's sand cast iron rainwater range combines the best of traditional qualities with modern technology to suit today's construction needs. Innovations include pre-finishing and advanced jointing techniques. Comprehensive components from stock can also be complemented by a made-to-order service.

The Harmer LCC cast iron soil and waste system is made to original imperial dimensions for use in refurbished and historic buildings. The standard finish for all pipes and fittings is factory-dipped bitumen.

Alumasc's steel rainwater system offers a contemporary, eco-friendly and cost effective alternative to uPVC gutters and downpipes.

Support Services

Comprehensive information and advice for specification and use of our rainwater products and systems is provided through our technical literature, website and the Alumasc Technical Services department. This is backed by proactive support on a project-by-project basis, led by specialist Area Managers.

Product Development

Alumasc routinely design, manufacture and patent new rainwater products for the UK and world markets.

Ongoing research and development ensures that our offer comprises high quality, world class products and systems that are fully accredited to UK and European standards.

Development of existing sound products and practices is central to the success of Alumasc and key to the way in which we provide our proven solutions. Equally, the basis for any new and innovative development is grounded in the knowledge and experience Alumasc has of its core manufacturing materials.

Alumasc's commitment to ongoing development and the promotion of best practice is reflected in our CPD programme which keeps the industry abreast of new standards and product solutions.



Benefits of Aluminium

Aluminium is a metal with exceptional characteristics, both in respect of its functional performance and sustainable credentials. It has become increasingly important in the construction industry, being used in ever more innovative ways by designers and specifiers.



Aluminium

A 'Green Material'

To be deemed 'green', a material or product should be recyclable, sustainable and versatile. Aluminium has all of these properties and its production is strictly monitored for responsible sourcing of raw materials.

Aluminium has a light weight-to-strength ratio, which means it is strong yet economical. The reduced weight provides benefits in material transportation and application. Aluminium can also be formed in a variety of ways to accommodate off-site fabrication.

Durable and Strong

Aluminium is resistant to corrosion and does not rust. It is weather-proof and is unaffected by the effects of UV rays, ensuring optimal performance over its lifetime.

Mixed with small amounts of other metal to form an alloy, aluminium can provide the strength of steel at only one third of the weight.

Recyclable

Historically, aluminium has proven to be one of the most important materials in successful recycling programs. It offers a high scrap value, widespread consumer acceptance, and enjoys significant industry support.

Most aluminium products are made from 100% recycled scrap. The recycling process does not result in any loss of the materials' basic qualities and properties.

Recycled aluminium offers significant energy benefits as remelting used aluminium requires only 5 percent of the energy needed to produce primary metal. As aluminium can be recycled indefinitely it need never be disposed of in landfill.

Versatile

Aluminium and its alloys can be easily formed and shaped by rolling, extrusion, forging and casting, characteristics that reflect the wide choice of form and visual appearance of aluminium in construction applications.

The Benefits at a Glance

- Corrosion resistant
- Lightweight
- Durable and strong
- Formable
- High strength to weight ratio
- Cryogenically strong
- Electrically conductive
- Non-combustible
- Non-magnetic
- Non-sparking
- Non-toxic
- Resilient
- Thermally conductive
- Fully recyclable



Benefits of Cast Iron and Steel

Cast iron, as a building material, has been around for much longer, and advances in technology have ensured that today's products are fully attuned to modern construction needs. Steel is an ideal metal for use as a roof drainage system. It's lighter than Cast Iron and Aluminium, making it easy to handle on site and offering a contemporary finish.



Cast Iron

High Strength

The crystalline structure of cast iron gives the material high strength and robustness. Once installed, cast iron components resist impact damage even in exposed areas, such as shopping centres, car parks and schools.

Durability

Inherent corrosion resistance coupled with a primed and a painted finish ensures that cast iron components will need minimal maintenance during the lifetime of the rainwater installation.

Recyclable

Made with almost 100% recycled scrap, cast iron can be recycled indefinitely, and therefore should not be disposed of in landfill.

The Benefits at a Glance

- Corrosion resistant when a protective coat is applied
- Durable and strong
- Impact resistant
- Non-combustible
- Non-toxic
- Fully recyclable

Steel

A 'Green Material'

Steel is a 'green' building material which is recyclable and versatile in its use. It has a high strength to weight ratio which means its strong yet economical and can be used to facilitate faster construction process such as off site fabrication. Steel is 98% recyclable, with recycled steel only requiring 40% of the energy to produce steel from its virgin state.

Durable and Strong

Steel is extremely durable with excellent tensile strength which gives the system robustness throughout its life on the building. It is unaffected by UV rays unlike plastic gutters so they won't colour fade or reduce the integrity of the system.

Life Expectancy

Galvanised steel has a long life expectancy in the excess of 50 years in most rural environments and 20-25 years plus, in urban and coastal environments. The longevity is further improved with the polyester powder coating option which is applied directly onto the galvanised finish.

Low Maintenance

Galvanised steel is very durable and therefore needs little maintenance, the zinc coating is inherently resistant to corrosion from the environment. It only requires an occasional washdown to clean any dirt and debris.

The Benefits at a Glance

- Corrosion resistant
- Lightweight
- Durable and strong
- Fully recyclable
- Cost-effective solution
- Minimum environmental impact



Alumasc Aluminium Rainwater Systems - Overview

Alumasc Rainwater Systems in aluminium, combine modern engineering and high performance materials to offer unrivalled choices and solutions for designers associated with fast track newbuild or refurbishment projects.



Traditional Aluminium

Heritage System

A stock range of traditional cast aluminium gutter profiles (half round, beaded half round, beaded deep run, victorian ogee and moulded), and traditional extruded aluminium pipework (round, square or rectangular), all in a choice of sizes and supported by a full range of fittings. Traditional jointing and fixing techniques are ideal for period and restoration projects, in a simple-to-install lightweight system. Can be finished to replicate cast iron, or with BBA certificated powder coatings in a wide range of colours - combining a striking retro look with the latest in paint technology.

Complementary rainwater heads for downpipes are available to suit. Can be finished to replicate cast iron, or with BBA certificated powder coatings in a wide choice of colours.

Alumasc can also create bespoke solutions to meet individual project requirements.



Contemporary Aluminium

Aqualine Gutter System

An extruded, high capacity gutter system in five alternative styles, each available in a choice of profile sizes. Tailor-made for today's fast track construction programmes in contemporary building design. Innovative secret fix bracketry, all weather 'dry' jointing fully accommodating thermal movement.

GX Gutter System

A pressed gutter system designed for traditional wet jointing on site. Offered in three profiles (joggle, smooth and moulded). High capacity, uncluttered appearance, and very cost-effective.

AX Gutter System

An extruded aluminium gutter system designed for traditional wet jointing on site. AX gutters are available in 3 profiles and a choice of sizes - ideal where a high capacity gutter system is required.

Flushjoint Downpipe System

A range of extruded round, square and rectangular downpipes with concealed spigots, giving a smooth, clean appearance. High impact resistance and offers excellent rigidity.

Flushjoint Downpipe System

A range of extruded round, square and rectangular downpipes with concealed spigots, giving a smooth, clean appearance. High impact resistance and offers excellent rigidity.

Swaged Downpipe System

An economical metal downpipe system with circular pipes available in a choice of three diameters.

Guardian Downpipe System

A range of extruded flush fitting security pipes in a choice of profiles. Guardian pipework has concealed brackets and concealed jointing, providing a high level of security.

Finishes

All four contemporary aluminium gutter and downpipe systems are available in a choice of BBA certificated powder coatings.

Interchangeability

The Aqualine, GX, Flushjoint and Guardian systems are interchangeable. Flushjoint and Guardian downpipes are also compatible with Heritage gutters.

In all cases, Alumasc can tailor designs to meet individual project requirements.

Alumasc Aluminium Rainwater Systems - Overview of Finishes

Alumasc Aluminium Rainwater Systems are available in plain mill finish or in the Raincote range of BBA approved, factory-applied polyester powder coatings.

Traditional & Contemporary Aluminium Rainwater Systems: In-House Powder Coatings

Alumasc's in-house powder coating plant gives both the control and the freedom to produce a range of colour finishes to a level not typically available in the construction industry. Utilising the technologies and procedures adopted for its automotive precision castings division, Alumasc benefits from high specification coating techniques that fulfil the rigors of testing prescribed by some of the worlds leading vehicle producers. Finishes of this quality maintain their appearance even when subject to harsh geographical weather conditions.

The aluminium undergoes a series of pretreatments to provide the ideal prepared surface to receive an electrostatically applied polyester powder in the chosen colour. This is then 'baked' and bonded to the fitting in a carefully controlled oven; the complete process is achieved on a continuous line to obtain the best results. The performance of polyester powder coated rainwater systems greatly exceeds that of site painted systems.

Approvals & Quality Control

Polyester powder coating is in accordance with BS EN 12206-1:2004. This refers to the coating of aluminium and aluminium alloys for architectural purposes. In the case of rainwater systems it is accepted that such coating is both decorative and protective. Alumasc systems will certainly be finished to this standard, and will in most cases exceed it.

Along with independent auditing to the ISO 9001:2008 Quality Management Standard, Alumasc maintains BBA certification for the powder coating of its aluminium rainwater goods in respect of longevity of performance and colour fastness - British Board of Agrément Certificate No. 86/1671.



RAL 1011m Brown Beige



RAL 1013m Pearl White



RAL 1021m Cadmium Yellow



RAL 2002m Vermilion



RAL 3003m Ruby Red



RAL 3005m Wine Red



RAL 5003m Sapphire Blue



RAL 5010m Flower Blue



RAL 6005m Moss Green



RAL 6018m Yellow Green



RAL 7005m Mouse Grey



RAL 7006m Beige Grey



RAL 7012m Basalt Grey



RAL 7015m Slate Grey



RAL 7016m Anthracite Grey



RAL 7024m Graphite Grey



RAL 7036m Platinum Grey



RAL 7037 Dusty Grey



RAL 7038 Agate Grey



RAL 8017m Chocolate Brown



RAL 8019m Grey Brown



RAL 9006m Metallic Silver



RAL 9006g Metallic Silver



RAL 9016m White



RAL 9017m Black



BLACK/TEX Textured Black

Choice of Colour

The standard aluminium Raincote range comprises 26 colours with additional colours with a BS or RAL number available to special order, subject to quantity and cost.

The colours reproduced on this page are for general guidance only.

Please contact Alumasc Technical Services for further information on colour choice and samples.

Alumasc Cast Iron Rainwater/Traditional Soil & Waste Systems - Overview

Alumasc Rainwater Systems in cast iron, combine modern engineering and high performance materials to offer unrivalled choices and solutions for designers associated with fast track newbuild or refurbishment projects.



Cast Iron: Standard

Apex Heritage System

A comprehensive, traditional range of four gutter and three downpipe profiles, all in a variety of sizes, together with associated fittings and accessories. The gutters include a choice of half round, beaded half round, victorian ogee and moulded. The downpipes are circular, square or rectangular.

Fittings and accessories include all the necessary items expected of a truly comprehensive rainwater system, ranging from stopends to extended bracketry, and shoes to hopperheads.

The system is available in a range of 8 standard colour options in a high quality two-pack epoxy primer and top coat finish. By removing the need for on-site pre-installation painting its offers up to 60% saving on time and 30% on cost. It is also available in a factory primed finish.

Cast Iron: Made to Order

Apex Heritage System

No standard product range can hope to satisfy all the stylistic options for new building, nor address the challenges of exact replacement for refurbishment and restoration. Apex Heritage Cast Iron Made to Order is specifically designed to meet these needs.

A range of decorative rainwater heads, for example, are readily available because Alumasc holds the patterns and can produce the items to order. The number of available made-to-order designs increases as additional patterns are created for new commissions.

A variety of different designs is possible for decorative earbelts, and additional enrichments can be incorporated into the rainwater heads where required.

Harmer LCC Cast Iron

A traditional socketed soil and waste pipe and fittings system manufactured to original imperial dimensions, created specifically for use in building refurbishment and historic building contracts where there is a need to faithfully reproduce period detail. This ensures a compatible interchange between old and new pipes and fittings.

An extensive range of fittings and accessories provides great flexibility in installation, while special detailing requirements can be catered for through Alumasc's fabrication and pattern making workshops.

Special welding techniques are also used to fabricate components where the alternative of making a pattern for casting would not be economic.

The standard finish for all pipes and fittings is factory-dipped bitumen.



Alumasc Cast Iron Rainwater/Traditional Soil & Waste Systems - Overview of Finishes

Alumasc Cast Iron Rainwater systems are available in a range of 8 standard colour options to suit tradition heritage projects. Alumasc's in-house paint plant produces a Certified Factory painted high quality two-pack epoxy primer and a top coat finish.

Apex Heritage Cast Iron Rainwater - Painted

The renowned quality of Apex Heritage Cast Iron is available pre-painted on all four gutter profiles (Half Round, Victorian Ogee, Beaded Half Round and Moulded) plus the full range of circular or square/rectangular downpipes with authentic socketed joints.

Now available in 8 standard colours to suit traditional heritage projects, other RAL colours are available on request.

The high performance two-pack epoxy primer and a top coat finish is factory-applied under controlled conditions and has been successfully developed to give a smooth and long lasting finish to the cast iron. The new certified factory painted finish marque guarantees the product has received the fully painted finish. This is certified with approved stickers on the product giving both the client and specifier piece of mind.

By removing the need for on-site pre-installation painting Alumasc's painted cast iron offers the following benefits:

- 60% saving on time, as there is no need to paint several coats on site
- Quicker installation and less disruption on site
- 30% saving on cost as there is no need for extra labour to paint on site
- The painted finish only costs 20% more than the primed finished product
- Durable, even and long lasting finish
- Independent test results conducted on the finish prove excellent resistance to salt, heat and frost



RAL 3009 Oxide Red



RAL 3020 Traffic Red



RAL 5010m Flower Blue



RAL 6005 Moss Green



RAL 7016 Anthracite Grey



RAL 8015 Chestnut Brown



RAL 9005 Black



RAL 9016 White

Apex Heritage Cast Iron Rainwater - Primed

A factory primed finish is also available with a one coat oxide primer. This primer will give protection against corrosion during transportation and short-term undercover storage and will provide a suitable surface for additional painting. On site handling and painting are the responsibility of the contractor.

Alumasc recommends that on site further priming coat be applied followed by 1 undercoat and 2 gloss coats of an alkyd paint system. All individual elements should receive the first gloss coats before fixing, and finished with the final gloss coat after the installation is complete. It is advisable to take the paint finish inside collars and within the ends of rainwater pipes to avoid the possibility of rust staining.

Harmer LCC Traditional Cast Iron Soil & Waste Systems

The pipes and fittings are factory-dipped in bitumen in accordance with BS 416. Where gloss painting is required, it is advisable to contact Alumasc technical services on 01744 648400.



Painted finish (RAL 9005 shown)



LCC bitumen finish

Alumasc Steel Rainwater System - Overview and Finishes

The Alumasc Steel Rainwater system offers a contemporary, eco-friendly and cost effective alternative to plastic gutter systems, available in a galvanised finish or a choice of standard colours to suit both commercial and domestic projects.

Steel: Overview

The gutter is available in a choice of four widths in the popular Half Round profile along with connecting round downpipe system in two sizes together with associated fittings and accessories including Rainwater Diverters and unique steel hopper head. The Gutter system provides high flow capacity due to the larger inlet funnels on the outlets.

The coating consists of three layers of protection comprising zinc corrosion protection, primer bonding coat and a 'Robust' polyester top coat. The surface coating is UV and scratch resistant and has been formally performance tested as follows:

- Scratch resistant to ≥ 30 N in accordance to EN123523-12-2004
- UV resistant RUV 4 in accordance with EN10169-2



- 1 Galvanised steel core
- 2 Zinc/magnesium corrosion protection layer
- 3 Primer bonding coat adds further corrosion resistance
- 4 Polyester top coat for maximum UV and scratch resistance

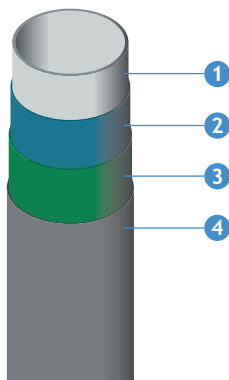

Steel: Finishes Overview

Standard Colour Finishes

Alumasc steel is available in a plain galvanised finish or in a highly durable and attractive polyester pre-coated black finish.



Galvanised Steel



RAL 9005m Black

Additional Colour Finishes

Alumasc steel is also available to order in a range of 6 contemporary colours, which are galvanised and then polyester power coated. Additional colours available on request.



RAL 6005m Moss Green



RAL 7016m Anthracite Grey



RAL 7037 Dusty Grey



RAL 8004m Copper Brown



RAL 8014m Sepia Brown



RAL 9002m Grey White

The colours reproduced on this page are for general guidance only.

Please contact Alumasc Technical Services for further information on colour choice and samples.

Alumasc Aluminium Rainwater Systems - Product Selector

Aluminium Rainwater Systems

Traditional Rainwater Systems

A range of traditional cast aluminium gutter profiles and extruded aluminium pipework with cast sockets and fittings.



See page 20



Heritage Gutters and Pipes: Standard

A range of traditional cast aluminium gutter profiles, half round, beaded half round, beaded deep run, victorian ogee and moulded, supported by a full range of fittings.

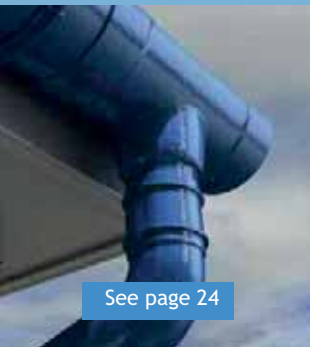

See page 24



See page 32



See page 36



See page 40

Heritage Non-Standard Products

Alumasc can design and manufacture a variety of gutters and pipes to create integrated bespoke solutions. Ornate holderbats and earbels can be detailed to provide a unique appearance.



See page 115



Alumasc Aluminium Rainwater Systems - Product Selector

Aluminium Rainwater Systems

Contemporary Rainwater Systems

Contemporary aluminium gutter profiles and downpipes to give a modern, smooth and uncluttered appearance to all new build contracts.



See page 44



Aqualine Gutters

A range of contemporary extruded aluminium gutter profiles in five styles, each in a choice of sizes. Complete with innovative secret-fix brackets.



See page 46

AX Gutters

An economical range of extruded aluminium gutter sections designed for traditional wet jointing on site. AX gutters are available in 3 profiles and a choice of sizes - ideal where a high capacity gutter system is required.

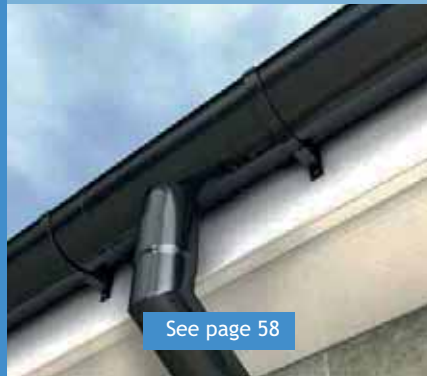

See page 58

GX Gutters

A range of contemporary pressed aluminium gutter profiles, in three styles, for traditional wet jointing on site. Suited for applications where maximum capacity gutters are required.



See page 66

Flushjoint Downpipes

A range of contemporary extruded aluminium downpipes, round, square and rectangular, with concealed spigots. High impact resistance.

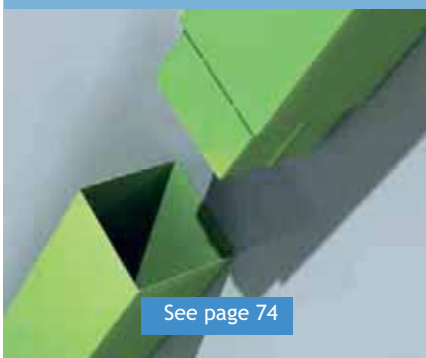

See page 74

Swaged Downpipes

An economical metal downpipe system with circular pipes available in a choice of three diameters.

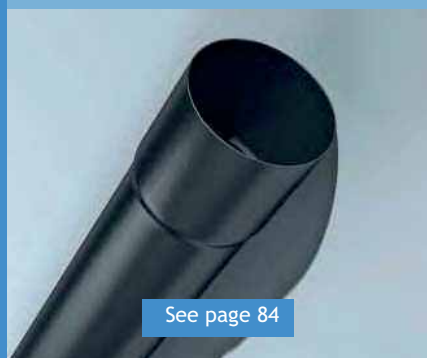

See page 84

Guardian Downpipes

A range of contemporary extruded aluminium security downpipes designed for mounting flush with the building fabric. The downpipes have concealed brackets and concealed jointing.



See page 90

Alumasc Cast Iron Rainwater/Soil & Waste Systems - Product Selector

Cast Iron Rainwater/Soil & Waste Systems

Apex Heritage Rainwater System

A comprehensive range of traditional gutter and downpipe profiles, in various sizes, incorporating all the architectural features required for new, refurbished or restored buildings, but in accord with modern fast track building methods.



See page 124

Apex Heritage Gutters and Pipes: Standard

Four gutter profiles, half round, beaded half round, victorian ogee and moulded, supported by a full range of fittings and fixtures.

Three downpipe profiles, in round, square and rectangular section in a choice of sizes.

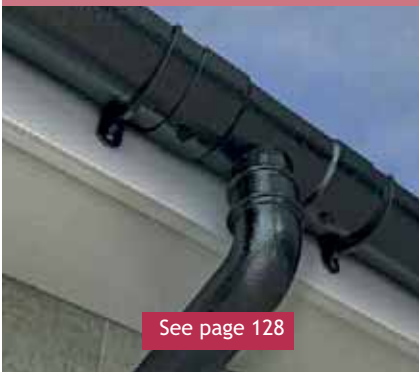

See page 128

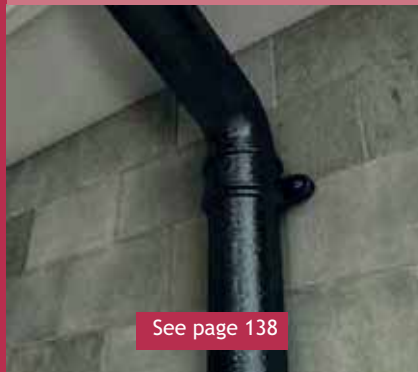

See page 138

Apex Heritage Products: Made to Order

Made to order components extend the choices available with stock items, fully addressing the challenges of exact replacement for refurbishment and restoration projects, as well as satisfying the stylistic options for new building.

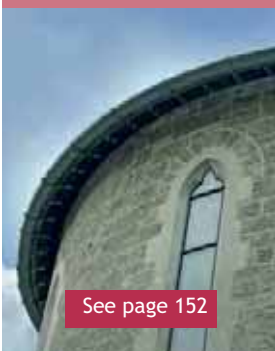

See page 152



See page 153



See page 155

Harmer LCC Soil & Waste

Traditional socketed cast iron pipes, fittings and accessories, made to imperial dimensions, and created to faithfully reproduce period detail in refurbishment and historic building contracts. Special detailing requirements can be fabricated in Alumasc's workshops.

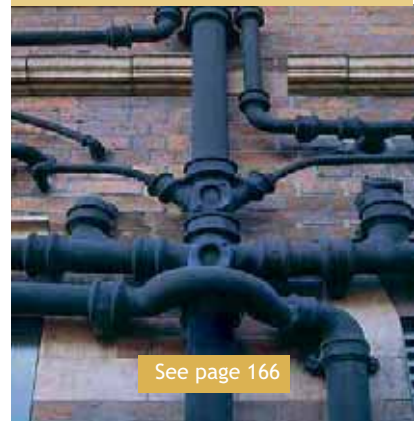

See page 166

Harmer LCC Pipes

Made in various lengths and diameters, they are available with or without ears, or can be double-collared.



See page 169

Harmer LCC Fittings

Holderbats, loose and slip couplings, socket reducers, variously angled bends, swan necks, diminishing pieces, single and double branches with or without access, bossed pipes, shoes and P traps are all available to create wide-ranging configurations.



See page 171

Alumasc Steel Rainwater Systems - Product Selector

Steel Rainwater System

Alumasc Steel System

A lightweight contemporary steel gutter and downpipe system available in the high flow half round profile, in a choice of widths, along with a connecting round downpipe system. Ideal for traditional and modern buildings both new build and refurbishment.



See page 184

Gutters

Half round gutters available in four sizes with a range of fixtures and fittings.

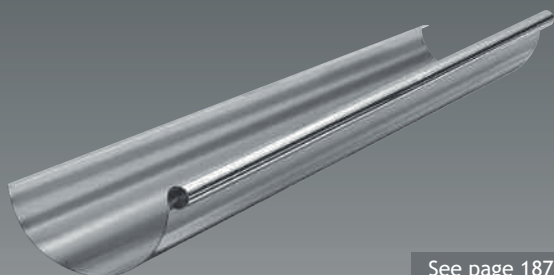

See page 187

Pipes

Circular downpipes available in two sizes to suit the gutter range, available with fittings and fixtures.



See page 188

Alumasc Rainwater Systems - Project Gallery

Alumasc aluminium and cast iron rainwater systems offer specifiers functional and stylistically appropriate solutions to rainwater drainage across all styles of building from traditional to contemporary.

Alumasc has a long and successful track record in architectural rainwater design.



Alumasc Rainwater Systems - Project Gallery

Mi-Space, Steel



Marriotts Walk shopping Centre, Heritage, Aqualine & Flushjoint



St. Pancras, Apex Heritage



Princesshay, Skyline, GX and Flushjoint



Waterstone Park, GX and Skyline



Woodhouse Triangle, Skyline, GX and Flushjoint

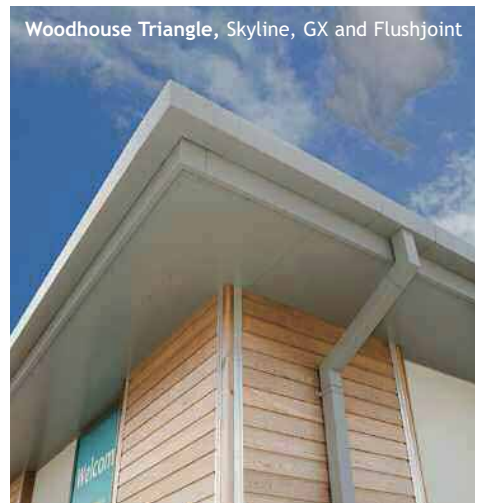

Alumasc Rainwater Systems

The Traditional Aluminium Range

This premium, high performance rainwater range features the Heritage cast aluminium system, available as extensive stock components or as non-standard bespoke items.



Traditional Aluminium Rainwater Range - Introduction

Heritage Cast Aluminium is a range of traditional profiles, fittings and accessories in cast aluminium. Designed to provide all the key architectural features appropriate to traditionally designed buildings either new build or refurbishment, in a lightweight fully finished product.



Heritage Cast Aluminium Rainwater System - Product Summary



Heritage - Half Round Gutter



Heritage - Beaded Half Round Gutter



Heritage - Beaded Deep Run Gutter



Heritage - Victorian Ogee Gutter



Heritage - Moulded Gutter



Heritage - Circular Pipe



Heritage - Square Pipe



Heritage - Rectangular Pipe

Heritage Cast Aluminium Rainwater System - Product Summary

Heritage is a comprehensive range of traditional gutter profiles, round, square and rectangular pipes and all associated fittings and accessories. Designed to provide all the essential architectural features appropriate to traditionally designed buildings, the Heritage range is also fully in tune with modern fast track building contracts.

Applications

- Ideal for traditionally designed buildings, in both new build and refurbishment applications
- Can be used as a direct replacement of cast iron
- For both flush and projecting eaves applications

Features & Performance

- 5 gutter and 3 downpipe profiles available in a choice of sizes
- Pipes available in 1, 2 and 3 metre lengths
- Lightweight, durable and non-corrodible
- Life expectancy of aluminium: 40 years (rural/suburban areas); up to 25 years (industrial/marine areas)
- Easy to handle and fix
- BBA approved
- Aluminium is 100% recyclable

Colours & Finishes

- BBA approved polyester powder coatings, factory applied at Alumasc
- 26 standard colours with additional BS or RAL colours available to special order
- Can be supplied to resemble cast iron surface texture (black only)
- Also available in plain mill finish for on-site painting

Manufacture





- UK manufactured by Alumasc
- Gutters and fixings made from LM6 marine grade aluminium alloy.
- Gutters are gravity diecast, fittings are pressure diecast and downpipes are extruded aluminium
- Manufactured in accordance with BS 8530 (formerly BS 2997)

Installation & Fixing



- Gutters are wet sealed with bolted joints, with a range of fixing options
- Gutter joints are secured with screws or bolts through integral holes/slots
- Victorian Ogee and Moulded gutters provided with slots in rear for direct fixing
- Brackets and fittings provided with fixing holes where appropriate
- Circular pipe jointing up to 100mm diameter is by separate sockets giving maximum flexibility for installation. 150mm circular pipes and all square and rectangular pipes have welded on sockets
- Simple fixing to wall by eared sockets or by a choice of pipe clips
- Minimal maintenance requirements



Gutter Profiles & Sizes

	Half Round 100mm (4") 113mm (4.5") 125mm (5") 150mm (6") HR6
	Beaded Half Round 113 (4.5) 125mm (5")
	Beaded Deep Run 113 x 75mm (4.5 x 3")
	Victorian Ogee 100mm (4") 113mm (4.5") 125mm (5")
	Moulded 100 x 75mm (4 x 3") 125 x 100mm (5 x 4") 150 x 100mm (6 x 4")

Pipe Profiles & Sizes

	Circular Pipe 63mm (2.5") 75mm (3") 100mm (4") 150mm (6")
	Square Pipe 75 x 75mm (3 x 3") 100 x 100mm (4 x 4")
	Rectangular Pipe 100 x 75mm (4 x 3")

Heritage - Half Round Gutters and Fittings



Heritage Half Round cast aluminium gutters are available in 4 sizes and 2 gutter lengths, together with a complete range of fittings. A classic socketed system, which can be finished to replicate cast iron or with BBA certificated powder coatings in a choice of colours.

Notes: All dimensions are in mm unless shown otherwise.
Gutter sizes shown are nominal.

Gutters

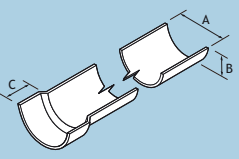
	Gutter Size	Gutter Length	A	B	C	T	Weight (kg)	Product Code
	100 (4")	1830mm	108	47	47	4	2.6	HR1/1
	113 (4.5")	"	122	52	47	4	4.0	HR2/16
	125 (5")	"	134	56	47	4	4.0	HR3/132
	150 (6")	"	xx	xx	xx	xx	xx	HR6/1830
	100 (4")	610mm	108	47	47	4	0.9	HR1/153
	113 (4.5")	"	122	52	47	4	1.4	HR2/154
	125 (5")	"	134	56	47	4	1.4	HR3/155

Note: T = Gutter Thickness (nominal +/- 1mm)

Union Clips

	Gutter Size	A	B	Product Code
	100	96	46	HR1/11
	113	96	46	HR2/26
	125	96	46	HR3/148
	150	96	46	HR6/UC

Stop-Ends

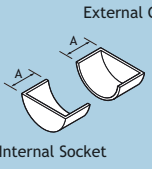
	Gutter Size	Type	A	Product Code
External Gutter	100	External	51	HR1/13
	113	"	51	HR2/28
	125	"	51	HR3/150
	150	"	51	HR6/SE/EXT
Internal Socket	100	Internal	45	HR1/12
	113	"	45	HR2/27
	125	"	45	HR3/149
	150	"	45	HR6/SE/INT

Fascia Brackets

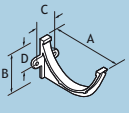
	Gutter Size	A	B	C	D	Product Code
	100	127	65	38	35	HR1/14
	113	140	70	38	40	HR2/29
	125	155	85	38	45	HR3/151
	150	xx	xx	38	xx	HR6/FB

Note: The products are available in a plain mill finish or with a BBA accredited polyester powder coated finish. Product codes in the tables refer to the mill finish. For polyester powder coated finish please add the suffix /PPC. Sundry items are not included as standard unless otherwise stated. Please order sundry items separately.

Heritage - Half Round Gutters and Fittings

Stop End Outlet - with Socket

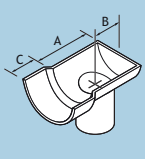
 External	Gutter Size	Pipe Size	A	B	C	Product Code
	100	63 dia	125	61	47	HR1/9
	113	"	125	61	47	HR2/24
	125	"	125	61	47	HR3/144
	125	75 dia	125	61	47	HR3/143
NOTE: DESIGNED TO FIT HERITAGE SOCKETED ALUMINIUM PIPES. ADD SUFFIX /F TO PRODUCT CODE TO FIT FLUSHJOINT OR GUARDIAN PIPES						

Stop End Outlet - with Spigot

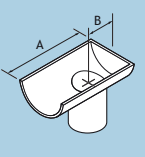
 Internal	Gutter Size	Pipe Size	A	B	Product Code
	100	63 dia	172	64	HR1/10
	113	"	172	64	HR2/25
	125	"	172	64	HR3/147
	125	75 dia	172	64	HR3/146
NOTE: DESIGNED TO FIT HERITAGE SOCKETED ALUMINIUM PIPES. ADD SUFFIX /F TO PRODUCT CODE TO FIT FLUSHJOINT OR GUARDIAN PIPES					

Running Outlet - with Double Socket

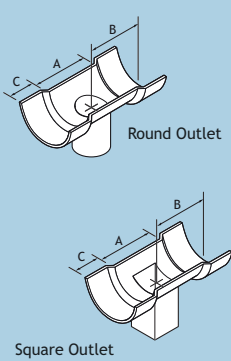
 Round Outlet Square Outlet	Gutter Size	Pipe Size	A	B	C	Product Code	
	100	63 dia	148	121	47	HR1/8	
	113	"	148	121	47	HR2/23	
	125	"	148	121	47	HR3/141	
	150	"	148	121	47	HR6/RO25	
	100	75 dia	148	121	47	HR1/367	
	113	"	148	121	47	HR2/3/23	
	125	"	148	121	47	HR3/140	
	150	"	148	121	47	HR6/RO30	
	125	100 dia	148	121	47	HR3/139	
	150	"	148	121	47	HR6/RO40	
	100	75 x 75	148	121	47	HR1/381	
	113	"	148	121	47	HR2/382	
	125	"	148	121	47	HR3/383	
	NOTE: DESIGNED TO FIT HERITAGE SOCKETED ALUMINIUM PIPES. ADD SUFFIX /F TO PRODUCT CODE TO FIT FLUSHJOINT OR GUARDIAN PIPES						

90° Angles

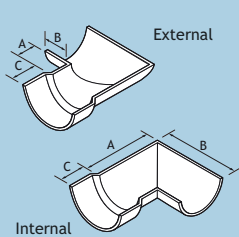
 External Internal	Gutter Size	Type	A	B	C	Product Code
	100	External	27	77	47	HR1/5
	113	"	27	77	47	HR2/20
	125	"	27	77	47	HR3/136
	150	"	27	77	47	HR6/90EXT
	100	Internal	132	183	47	HR1/4
	113	"	146	197	47	HR2/19
	125	"	157	210	47	HR3/135
	150	"	xx	xx	47	HR6/90INT

135° Angles

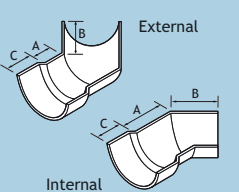
 External Internal	Gutter Size	Type	A	B	C	Product Code
	100	External	27	77	47	HR1/7
	113	"	27	77	47	HR2/22
	125	"	27	77	47	HR3/138
	100	Internal	70	120	47	HR1/6
	113	"	70	120	47	HR2/21
	125	"	70	120	47	HR3/137

Note: The products are available in a plain mill finish or with a BBA accredited polyester powder coated finish. Product codes in the tables refer to the mill finish. For polyester powder coated finish please add the suffix /PPC. Sundry items are not included as standard unless otherwise stated. Please order sundry items separately.

Heritage - Beaded Half Round Gutters and Fittings



Heritage Beaded Half Round socketed cast aluminium gutters are available in 2 sizes and 2 gutter lengths, together with a complete range of fittings. There is a pronounced feature bead on both lips. Can be finished to replicate cast iron or with BBA certificated powder coatings in a choice of colours.

Notes: Beaded Half Round is an all socketed system and Union Clips are only available by special order.

All dimensions are in mm unless shown otherwise.

Gutter sizes shown are nominal.

Gutters

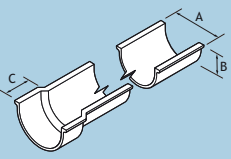
	Gutter Size	Gutter Length	A	B	C	T	Weight (kg)	Product Code
	113 (4.5")	1830mm	131	52	47	4	3.0	BHR5/300
	125 (5")	"	143	56	47	4	3.0	BHR6/325
	113 (4.5")	610mm	131	52	47	4	1.0	BHR5/303
	125 (5")	"	143	56	47	4	1.0	BHR6/328

Note: T = Gutter Thickness (nominal +/- 1mm)

Stop-Ends

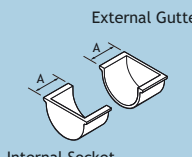
	Gutter Size	Type	A	Product Code
	113	External	51	BHR5/306
	125	"	51	BHR6/331
	113	Internal	45	BHR5/318
	125	"	45	BHR6/149

Fascia Brackets

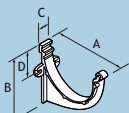
	Gutter Size	A	B	C	D	Product Code
	113	155	75	38	35	BHR5/315
	125	165	79	38	37	BHR6/337

Stop End Outlet - with Socket

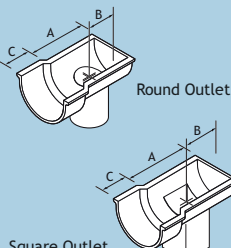
	Gutter Size	Pipe Size	A	B	C	Product Code
	113	63 dia	213	106	47	BHR5/RO25SE
	125	"	213	106	47	BHR6/RO25SE
	113	75 dia	213	106	47	BHR5/RO30SE
	125	"	213	106	47	BHR6/RO30SE
	113	75 x 75	213	106	47	BHR5/SO33SE
	125	"	213	106	47	BHR6/SO33SE

NOTE: DESIGNED TO FIT HERITAGE SOCKETED ALUMINIUM PIPES. ADD SUFFIX /F TO PRODUCT CODE TO FIT FLUSHJOINT OR GUARDIAN PIPES

Note: The products are available in a plain mill finish or with a BBA accredited polyester powder coated finish. Product codes in the tables refer to the mill finish. For polyester powder coated finish please add the suffix /PPC. Sundry items are not included as standard unless otherwise stated. Please order sundry items separately.

Heritage - Beaded Half Round Gutters and Fittings

Running Outlet - with Single Spigot/Socket

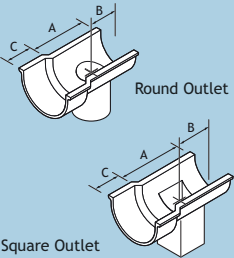
	Gutter Size	Pipe Size	A	B	C	Product Code
	Round Outlet	113	63 dia	213	106	47
	125	"	213	106	47	BHR6/330
Square Outlet	113	75 dia	213	106	47	BHR5/308
	125	"	213	106	47	BHR6/333
	113	75 x 75	213	106	47	BHR5/SO33
	125	"	213	106	47	BHR6/SO33

NOTE: DESIGNED TO FIT HERITAGE SOCKETED ALUMINIUM PIPES. ADD SUFFIX /F TO PRODUCT CODE TO FIT FLUSHJOINT OR GUARDIAN PIPES

Running Outlet - with Double Socket

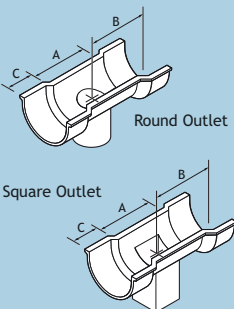
	Gutter Size	Pipe Size	A	B	C	Product Code
	Round Outlet	113	63 dia	213	160	47
	125	"	213	160	47	BHR6/329
Square Outlet	113	75 dia	213	160	47	BHR5/307
	125	"	213	160	47	BHR6/332
	113	75 x 75	213	160	47	BHR5/384
	125	"	213	160	47	BHR6/385

NOTE: DESIGNED TO FIT HERITAGE SOCKETED ALUMINIUM PIPES. ADD SUFFIX /F TO PRODUCT CODE TO FIT FLUSHJOINT OR GUARDIAN PIPES

90° Angles

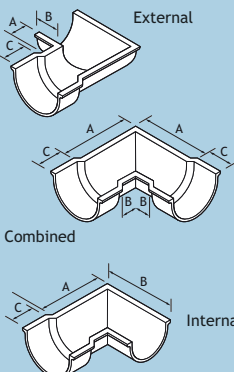
	Gutter Size	Type	A	B	C	Product Code
	External	113	External	62	62	47
	125	"	62	62	47	BHR6/336
Combined	113	Combined	192	62	47	BHR5/309
	125	"	192	62	47	BHR6/334
Internal	113	Internal	192	192	47	BHR5/310
	125	"	192	192	47	BHR6/335

135° Angles

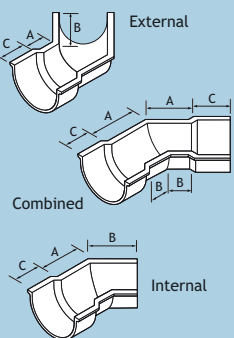
	Gutter Size	Type	A	B	C	Product Code
	External	113	External	62	62	47
	125	"	62	62	47	BHR6/EA135
Combined	113	Combined	192	62	47	BHR5/IA135D
	125	"	192	62	47	BHR6/IA135D
Internal	113	Internal	192	192	47	BHR5/IA135
	125	"	192	192	47	BHR6/IA135

Note: The products are available in a plain mill finish or with a BBA accredited polyester powder coated finish. Product codes in the tables refer to the mill finish. For polyester powder coated finish please add the suffix /PPC. Sundry items are not included as standard unless otherwise stated. Please order sundry items separately.

Heritage - Beaded Deep Run Gutters and Fittings



Heritage Beaded Deep Run gutters offer high flow capacity in one gutter size. A socketed system, which can be finished to replicate cast iron or with BBA certificated powder coatings in a choice of colours.

Notes: Beaded Deep Run is an all socketed system and Union Clips are only available by special order.

All dimensions are in mm unless shown otherwise.

Gutter sizes shown are nominal.

Gutters

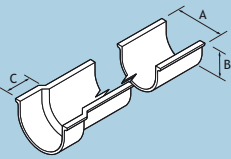
	Gutter Size	Gutter Length	A	B	C	T	Weight (kg)	Product Code
	113 x 75 (4.5" x 3")	1830mm	137	76	47	4	2.6	HR4/243
113 x 75 (4.5" x 3")	610mm	137	76	47	4	0.9	HR4/246	

Note: T = Gutter Thickness (nominal +/- 1mm)

Stop-Ends

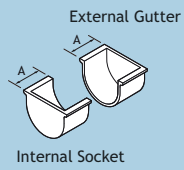
	Gutter Size	Type	A	Product Code
	113 x 75	External	42	HR4/250
113 x 75	Internal	42	HR4/249	

Fascia Brackets

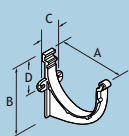
	Gutter Size	A	B	C	D	Product Code
	113 x 75	155	111	38	55	HR4/251

Note: Each fascia bracket is supplied with a nylon retaining clip

Note: The products are available in a plain mill finish or with a BBA accredited polyester powder coated finish. Product codes in the tables refer to the mill finish. For polyester powder coated finish please add the suffix /PPC. Sundry items are not included as standard unless otherwise stated. Please order sundry items separately.

Heritage - Beaded Deep Run Gutters and Fittings

Running Outlet - with Double Socket

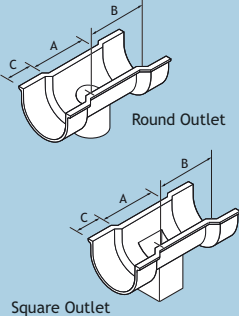
	Gutter Size	Pipe Size	A	B	C	Product Code
	113 x 75	63 dia	208	151	47	HR4/248
	113 x 75	75 dia	208	151	47	HR4/369
	113 x 75	75 x 75	208	151	47	HR4/410
	113 x 75	100 x 75	208	151	47	HR4/411
NOTE: DESIGNED TO FIT HERITAGE SOCKETED ALUMINIUM PIPES. ADD SUFFIX /F TO PRODUCT CODE TO FIT FLUSHJOINT OR GUARDIAN PIPES						

90° Angles - with Double Socket

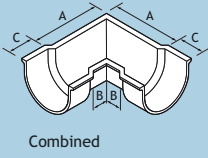
	Gutter Size	Type	A	B	C	Product Code
	113 x 75	Combined Internal/External	200	55	47	HR4/247

135° Angles - with Double Socket

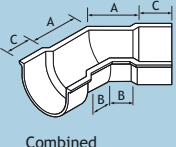
	Gutter Size	Type	A	B	C	Product Code
	113 x 75	Combined Internal/External	112	55	47	HR4/371

Note: The products are available in a plain mill finish or with a BBA accredited polyester powder coated finish. Product codes in the tables refer to the mill finish. For polyester powder coated finish please add the suffix /PPC. Sundry items are not included as standard unless otherwise stated. Please order sundry items separately.

Heritage - Victorian Ogee Gutters and Fittings



Heritage Victorian Ogee gutters are available in 3 sizes and 2 gutter lengths, together with a complete range of fittings. The traditional Ogee gutter profile is ideal for period applications and restoration. A left-hand socketed system, which can be finished to replicate cast iron or with BBA certificated powder coatings in a choice of colours.

Notes: All dimensions are in mm unless shown otherwise.

Gutter sizes shown are nominal.

Gutters

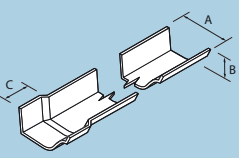
	Gutter Size	Gutter Length	A	B	C	T	Weight (kg)	Product Code
	100 (4")	1830mm	110	54	47	4	2.6	OG1/31
	113 (4.5")	"	121	60	47	4	4.0	OG2/45
	125 (5")	"	135	68	47	4	4.0	OG3/173
	100 (4")	610mm	110	54	47	4	0.9	OG1/156
	113 (4.5")	"	121	60	47	4	1.4	OG2/157
	125 (5")	"	135	68	47	4	1.4	OG3/176
Note: Victorian Ogee is a left hand socket system T = Gutter Thickness (nominal +/- 1mm)								

Union Clips

	Gutter Size	A	B	Product Code
	100	98	47	OG1/41
	113	98	47	OG2/55
	125	98	47	OG3/184

Stop-Ends

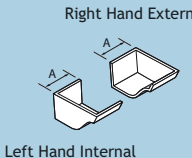
	Gutter Size	Type	A	Product Code
Right Hand External Left Hand Internal	100	Right Hand External	51	OG1/43
	113	"	51	OG2/57
	125	"	51	OG3/186
	100	Left Hand Internal	45	OG1/42
	113	"	45	OG2/56
	125	"	45	OG3/185

Fascia Brackets

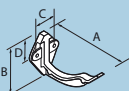
	Gutter Size	A	B	C	D	Product Code
	100	125	80	38	32	OG1/44
	113	137	85	38	38	OG2/58
	125	150	92	38	38	OG3/187

Note: The products are available in a plain mill finish or with a BBA accredited polyester powder coated finish. Product codes in the tables refer to the mill finish. For polyester powder coated finish please add the suffix /PPC. Sundry items are not included as standard unless otherwise stated. Please order sundry items separately.

Heritage - Victorian Ogee Gutters and Fittings

Left Hand Stop End Outlet - with Spigot

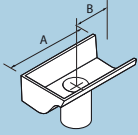
	Gutter Size	Pipe Size	A	B	Product Code
	100	63 dia	172	64	OG1/40
	113	"	172	64	OG2/54
	125	"	172	64	OG3/183
	125	75 dia	172	64	OG3/3/183
NOTE: DESIGNED TO FIT HERITAGE SOCKETED ALUMINIUM PIPES. ADD SUFFIX /F TO PRODUCT CODE TO FIT FLUSHJOINT OR GUARDIAN PIPES					

Right Hand Stop End Outlet - with Socket

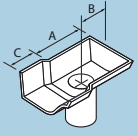
	Gutter Size	Pipe Size	A	B	C	Product Code
	100	63 dia	126	64	47	OG1/39
	113	"	126	64	47	OG2/53
	125	"	126	64	47	OG3/182
	125	75 dia	126	64	47	OG3/3/182
NOTE: DESIGNED TO FIT HERITAGE SOCKETED ALUMINIUM PIPES. ADD SUFFIX /F TO PRODUCT CODE TO FIT FLUSHJOINT OR GUARDIAN PIPES						

Running Outlet - with Single Spigot/Socket

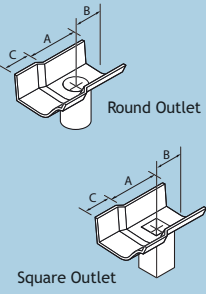
	Gutter Size	Pipe Size	A	B	C	Product Code
	100	63 dia	194	121	47	OG1/38
	113	"	194	121	47	OG2/52
	125	"	194	121	47	OG3/181
	113	75 dia	194	121	47	OG2/368
	125	"	194	121	47	OG3/3/181
	100	75 x 75	194	121	47	OG1/386
	113	"	194	121	47	OG2/387
	125	"	194	121	47	OG3/388
	NOTE: DESIGNED TO FIT HERITAGE SOCKETED ALUMINIUM PIPES. ADD SUFFIX /F TO PRODUCT CODE TO FIT FLUSHJOINT OR GUARDIAN PIPES					

90° Angles

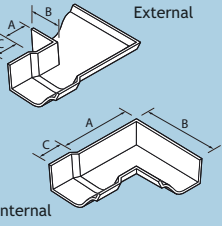
	Gutter Size	Type	A	B	C	Product Code
	100	External	25	75	47	OG1/34
	113	"	25	75	47	OG2/48
	125	"	25	75	47	OG3/177
	100	Internal	133	184	47	OG1/35
	113	"	146	197	47	OG2/49
	125	"	159	210	47	OG3/178

135° Angles

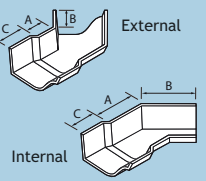
	Gutter Size	Type	A	B	C	Product Code
	100	External	25	75	47	OG1/36
	113	"	25	75	47	OG2/50
	125	"	25	75	47	OG3/179
	100	Internal	70	121	47	OG1/37
	113	"	75	126	47	OG2/51
	125	"	80	134	47	OG3/180

Note: The products are available in a plain mill finish or with a BBA accredited polyester powder coated finish. Product codes in the tables refer to the mill finish. For polyester powder coated finish please add the suffix /PPC. Sundry items are not included as standard unless otherwise stated. Please order sundry items separately.

Heritage - Moulded Gutters and Fittings



Heritage Moulded gutters are available in 3 sizes and 2 gutter lengths, together with a complete range of fittings. A socketed system, which can be finished to replicate cast iron or with BBA certificated powder coatings in a choice of colours. Ideal for restoration or contemporary applications.

Notes: All dimensions are in mm unless shown otherwise.
Gutter sizes shown are nominal.

Gutters

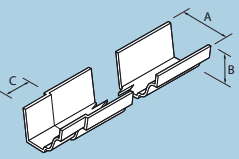
	Gutter Size	Gutter Length	A	B	C	T	Weight (kg)	Product Code
	100 x 75 (4" x 3")	1830mm	108	76	50	4	4.0	MG2/217
	125 x 100 (5" x 4")	"	140	102	50	4	5.4	MG1/196
	150 x 100 (6" x 4")	"	162	102	50	4	5.6	MG3/259
	100 x 75 (4" x 3")	610mm	108	76	50	4	1.4	MG2/220
	125 x 100 (5" x 4")	"	140	102	50	4	1.8	MG1/199
	150 x 100 (6" x 4")	"	162	102	50	4	1.9	MG3/262
Note: 100 x 75 and 125 x 100 moulded gutters are left hand spigot. 150 x 100 moulded gutter is right hand spigot T = Gutter Thickness (nominal +/- 1mm)								

Union Clips

	Gutter Size	A	B	Product Code
	100 x 75	100	46	MG2/231
	125 x 100	100	46	MG1/213
	150 x 100	100	46	MG3/269

Stop-Ends

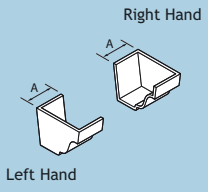
	Gutter Size	Type	A	Product Code
	100 x 75	External Left Hand	50	MG2/233
	125 x 100	"	50	MG1/215
	150 x 100	External Right Hand	50	MG3/271
	100 x 75	Internal Right Hand	50	MG2/232
	125 x 100	"	50	MG1/214
	150 x 100	Internal Left Hand	50	MG3/270

Fixing Supports

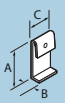
	Gutter Size	A	B	C	Product Code
	100 x 75	70	10	36	MG2/373
	125 x 100	94	12	36	MG1/374
	150 x 100	94	12	36	MG3/375

Fascia Brackets

	Gutter Size	A	B	C	D	Product Code
	100 x 75	136	135	38	38	MG2/234
	125 x 100	135	136	38	39	MG1/216
	150 x 100	162	125	38	39	MG3/268

Note: See footer on page 33.

Heritage - Moulded Gutters and Fittings

Running Outlet - with Single Spigot

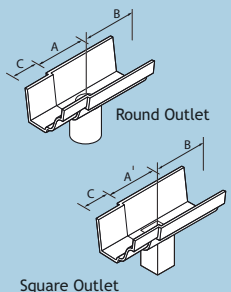
 Round Outlet Square Outlet	Gutter Size	Pipe Size	A	B	C	Spigot	Product Code
	NOTE: DESIGNED TO FIT HERITAGE SOCKETED ALUMINIUM PIPES. ADD SUFFIX /F TO PRODUCT CODE TO FIT FLUSHJOINT OR GUARDIAN PIPES	100 x 75	63 dia	190	120	50	Left Hand
125 x 100		"	190	120	50	Left Hand	MG1/205
150 x 100		"	190	120	50	Right Hand	MG3/267
100 x 75		75 dia	190	120	50	Left Hand	MG2/370
125 x 100		"	190	120	50	Left Hand	MG1/204
150 x 100		"	190	120	50	Right Hand	MG3/266
125 x 100		100 dia	190	120	50	Left Hand	MG1/253
150 x 100		"	190	120	50	Right Hand	MG3/265
100 x 75		75 x 75	190	120	50	Left Hand	MG2/356
125 x 100		"	190	120	50	Left Hand	MG1/358
150 x 100		"	190	120	50	Right Hand	MG3/361
100 x 75		100 x 75	190	120	50	Left Hand	MG2/357
125 x 100		"	190	120	50	Left Hand	MG1/359
150 x 100		"	190	120	50	Right Hand	MG3/362
125 x 100		100 x 100	190	120	50	Left Hand	MG1/360
150 x 100		"	190	120	50	Right Hand	MG3/363

90° Angles

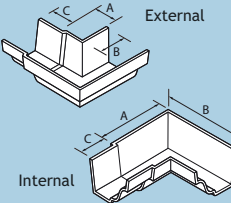
 External Internal	Gutter Size	Type	A	B	C	Spigot	Product Code
		100 x 75	External	25	75	50	Left Hand
125 x 100		"	25	75	50	Left Hand	MG1/200
150 x 100		"	25	75	50	Right Hand	MG3/263
100 x 75		Internal	127	183	50	Left Hand	MG2/222
125 x 100		"	158	215	50	Left Hand	MG1/201
150 x 100		"	185	238	50	Right Hand	MG3/264

135° Angles

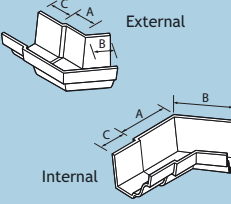
 External Internal	Gutter Size	Type	A	B	C	Spigot	Product Code
		100 x 75	External	25	75	50	Left Hand
125 x 100		"	25	75	50	Left Hand	MG1/202
150 x 100		"	25	75	50	Right Hand	MG3/272
100 x 75		Internal	62	120	50	Left Hand	MG2/224
125 x 100		"	79	130	50	Left Hand	MG1/203
150 x 100		"	90	144	50	Right Hand	MG3/273

145° Angles

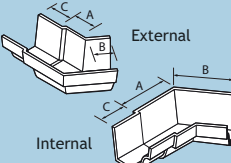
 External Internal	Gutter Size	Type	A	B	C	Spigot	Product Code
		125 x 100	External	25	75	50	Left Hand
150 x 100		"	25	75	50	Right Hand	MG3/333
125 x 100		Internal	97	47	50	Left Hand	MG1/330
150 x 100		"	118	68	50	Right Hand	MG3/334

150° Angles

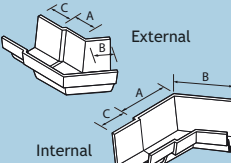
 External Internal	Gutter Size	Type	A	B	C	Spigot	Product Code
		125 x 100	External	25	75	50	Left Hand
150 x 100		"	25	75	50	Right Hand	MG3/335
125 x 100		Internal	94	44	50	Left Hand	MG1/332
150 x 100		"	118	68	50	Right Hand	MG3/336

Note: The products are available in a plain mill finish or with a BBA accredited polyester powder coated finish. Product codes in the tables refer to the mill finish. For polyester powder coated finish please add the suffix /PPC. Sundry items are not included as standard unless otherwise stated. Please order sundry items separately.

Heritage - Cast Aluminium Bracketry

Alumasc can provide traditional style Bracketry for all of its standard gutter profiles. Where building detailing dictates, Alumasc can provide bespoke Bracketry to meet individual project requirements.

Universal Brackets

For use with standard Fascia Bracket (purchased separately).

Universal Rafter Arm

	Type	Angle	Product Code
	Top Fix	26°	UNI632915
	Top Fix	40°	UNI632916
	Side Fix	26°	UNI632917
	Side Fix	40°	UNI632918

Universal Drive in Rise & Fall

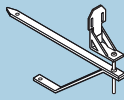
	Gutter Size	Product Code
	Universal	UNI632919

Traditional 'Old' Style Gutter Brackets

Top Fix Rafter Arm - Half Round

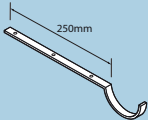
	Gutter Size	Product Code
	100	HR1/RB/TF
	113	HR2/RB/TF
	125	HR3/RB/TF
Note: Supplied with 40° angle of pitch as standard. Other pitches catered for on request - please specify pitch angle required.		

Top Fix Rafter Arm - Beaded Half Round/Deep Run

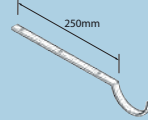
	Gutter Size	Product Code
	113	BHR5/RB/TF
	125	BHR6/RB/TF
	113 x 75 Deep Run	HR4/RB/TF
Note: Supplied with 40° angle of pitch as standard. Other pitches catered for on request - please specify pitch angle required.		

Top Fix Rafter Arm - Victorian Ogee

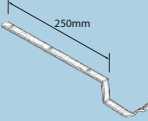
	Gutter Size	Product Code
	100	OG1/RB/TF
	113	OG2/RB/TF
	125	OG3/RB/TF
Note: Supplied with 40° angle of pitch as standard. Other pitches catered for on request - please specify pitch angle required.		

Top Fix Rafter Arm - Moulded

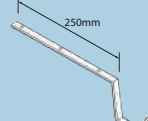
	Gutter Size	Product Code
	100 x 75	MG2/RB/TF
	125 x 100	MG1/RB/TF
	150 x 100	MG3/RB/TF
Note: Supplied with 40° angle of pitch as standard. Other pitches catered for on request - please specify pitch angle required.		

Side Fix Rafter Arm - Half Round

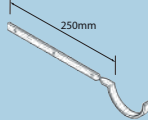
	Gutter Size	Product Code
	100	HR1/RB/SF
	113	HR2/RB/SF
	125	HR3/RB/SF
Note: Supplied with 40° angle of pitch as standard. Other pitches catered for on request - please specify pitch angle required.		

Side Fix Rafter Arm - Beaded Half Round/Deep Run

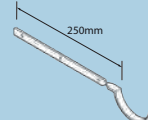
	Gutter Size	Product Code
	113	BHR5/RB/SF
	125	BHR6/RB/SF
	113 x 75 Deep Run	HR4/RB/SF
Note: Supplied with 40° angle of pitch as standard. Other pitches catered for on request - please specify pitch angle required.		

Side Fix Rafter Arm - Victorian Ogee

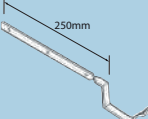
	Gutter Size	Product Code
	100	OG1/RB/SF
	113	OG2/RB/SF
	125	OG3/RB/SF
Note: Supplied with 40° angle of pitch as standard. Other pitches catered for on request - please specify pitch angle required.		

Side Fix Rafter Arm - Moulded

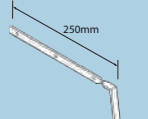
	Gutter Size	Product Code
	100 x 75	MG2/RB/SF
	125 x 100	MG1/RB/SF
	150 x 100	MG3/RB/SF
Note: Supplied with 40° angle of pitch as standard. Other pitches catered for on request - please specify pitch angle required.		

Note: The products are available in a plain mill finish or with a BBA accredited polyester powder coated finish. Product codes in the tables refer to the mill finish. For polyester powder coated finish please add the suffix /PPC. Sundry items are not included as standard unless otherwise stated. Please order sundry items separately.

Heritage - Cast Aluminium Bracketry

Rise & Fall - Half Round

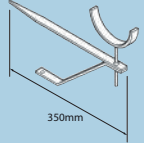
	Gutter Size	Product Code
	100	HR1/R&F/ASSY
	113	HR2/R&F/ASSY
	125	HR3/R&F/ASSY

Rise & Fall - Beaded Half Round/Deep Run

	Gutter Size	Product Code
	113	BHR5/R&F/ASSY
	125	BHR6/R&F/ASSY
	113 x 75 Deep Run	HR4/R&F/ASSY

Rise & Fall - Victorian Ogee

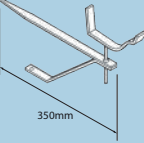
	Gutter Size	Product Code
	100	OG1/R&F/ASSY
	113	OG2/R&F/ASSY
	125	OG3/R&F/ASSY

Rise & Fall - Moulded

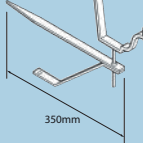
	Gutter Size	Product Code
	100 x 75	MG2/R&F/ASSY
	125 x 100	MG1/R&F/ASSY
	150 x 100	MG3/R&F/ASSY



Bespoke Bracketry

Alumasc can design and manufacture a variety of Bracketry solution for gutters and pipes to create an integrated system solution. Such detailing can often be used to support fascia and soffit configurations.

Ornate holderbats and earbelts can be detailed to provide a unique, distinguished appearance to a rainwater stack.

Where standard fitting dimensions do not suit the project's requirements, Alumasc can fabricate its gutter and pipe Bracketry systems to accommodate building design.

Note: The products are available in a plain mill finish or with a BBA accredited polyester powder coated finish. Product codes in the tables refer to the mill finish. For polyester powder coated finish please add the suffix /PPC. Sundry items are not included as standard unless otherwise stated. Please order sundry items separately.

Heritage - Circular Pipes and Fittings



Heritage Circular Pipes are available in 4 pipe diameters and 3 pipe lengths, together with a complete range of fittings. Complementary rainwater heads are also available. Can be factory finished to replicate cast iron or with BBA certificated powder coatings in a range of colours.

Notes: Pipes are extruded sections with cast sockets. The majority of fittings are cast, however certain fittings are fabricated. Contact Alumasc for further details

All dimensions are in mm unless shown otherwise.

Pipe sizes shown are nominal.

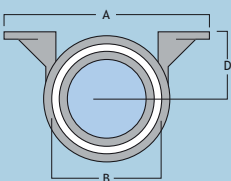
	Sockets (Nominal)	63	75	100	150
	A Length of flange overall		144	160	187
B Internal diameter		73.5 to 70	85 to 81.5	110 to 108	163 to 160
C Height of socket		89	95	90	125
D Distance from centre line of pipe to wall		65	71	90	118

Note: All circular sockets are an interference fit with exception of 150mm which are factory welded

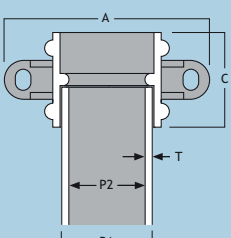
	Pipes (Nominal)	63	75	100	150
	P1 External Diameter		63	76.5	102
P2 Internal Diameter		60.5	74	98.5	147
T Thickness		1.22	1.22	1.6	2.5

Pipes - With and Without Ears

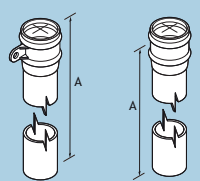
	Pipe Size	A	Product Code
	Note: The codes given above are for pipes with ears. For pipes without ears suffix codes with /NE 63, 75 and 100mm pipes are supplied with separate interference-fit cast sockets	63 (2.5")	3000mm
"		2000mm	RW1/2M
"		1000mm	RW1/1M
	75 (3")	3000mm	RW2/3M
	"	2000mm	RW2/2M
	"	1000mm	RW2/1M
	100 (4")	3000mm	RW3/3M
	"	2000mm	RW3/2M
	"	1000mm	RW3/1M
	150 (6")	3000mm	RW60/3M
	"	2000mm	RW60/2M
	"	1000mm	RW60/1M

Note: The products are available in a plain mill finish or with a BBA accredited polyester powder coated finish. Product codes in the tables refer to the mill finish. For polyester powder coated finish please add the suffix /PPC. Sundry items are not included as standard unless otherwise stated. Please order sundry items separately.

Heritage - Circular Pipes and Fittings

Thickwall Pipes - With Ears

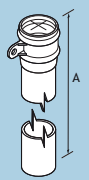
	Pipe Size	A	Thickness	Product Code
	63 dia	2000mm	3	RWT/25/2M
	75 dia	2000mm	3	RWT/30/2M
	100 dia	2000mm	3	RWT/40/2M
Note: The codes given above are for pipes with ears. For pipes without ears suffix codes with /NE 63, 75 and 100mm pipes are supplied with separate interference-fit cast sockets				

Bends - Without Ears

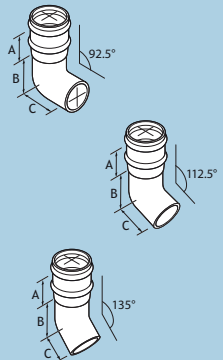
	Pipe Size	Type	A	B	C	Product Code
	63 dia	92.5 Degree	89	21	140	RW1/69
	75 dia	"	95	15	146	RW2/83
	100 dia	"	90	80	159	RW3/128
	150 dia	"	125	114	109	RW60/B/92
	63 dia	112.5 Degree	89	32	110	RW1/70
	75 dia	"	95	26	120	RW2/84
	100 dia	"	90	43	110	RW3/129
	150 dia	"	125	85	144	RW60/B/112
	63 dia	135 Degree	89	41	107	RW1/165
	75 dia	"	95	35	120	RW2/327
	100 dia	"	90	43	110	RW3/328
	150 dia	"	125	85	144	RW60/B/135

Branches - Without Ears

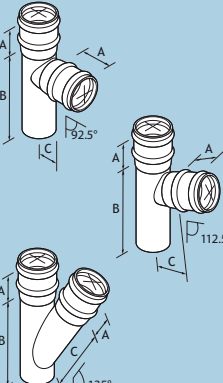
	Pipe Size	Type	A	B	C	Product Code
	63 dia	92.5 Degree	70	200	79	RW1/67
	75 dia	"	70	220	85	RW2/81
	100 dia	"	90	240	108	RW3/126
	150 dia	"	125	315	206	RW60/BR/92
	63 dia	112.5 Degree	70	200	79	RW1/68
	75 dia	"	70	220	85	RW2/82
	100 dia	"	65	265	108	RW3/127
	150 dia	"	125	135	206	RW60/BR/112
	63 dia	135 Degree	70	200	79	RW1/BR/135
	75 dia	"	70	220	85	RW2/BR/135
	100 dia	"	90	300	180	RW3/BR/135
	150 dia	"	125	375	245	RW60/BR/135

Round Pipe Sockets - With Ears

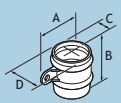
	Pipe Size	A	B	C	D	Product Code
	63 dia	144	89	65	73.5 to 70	RW1/240
	75 dia	160	95	71	86.5 to 81	RW2/241
	100 dia	187	90	90	110 to 108	RW3/242
	150 dia	245	125	118	163 to 160	RW60/PS
Note: The codes given above are for sockets with ears. For sockets without ears suffix codes with /NE						

Access Pipes - Without Ears

	Pipe Size	A	B	Product Code
	63 dia	95	245	RW1/256
	75 dia	95	245	RW2/257
	100 dia	95	245	RW3/258
	150 dia	125	295	RW60/ACP

Note: See footer on page 36.

Heritage - Circular Pipes and Fittings

112.5° One Part Offsets - Without Ears

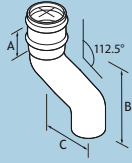

Note: Offsets in the 150mm Rainwater pipe range are fabricated, cut and mitred.

Pipe Size	Offset	A	B	C	Product Code
63 dia	75 (3")	70	184	76	RW1/87
"	113 (4.5")	70	200	114	RW1/163
"	150 (6")	70	215	152	RW1/62
"	225 (9")	70	247	228	RW1/63
"	300 (12")	70	279	304	RW1/64
"	375 (15")	70	310	381	RW1/65
"	450 (18")	70	342	457	RW1/88
"	525 (21")	70	373	533	RW1/89
"	600 (24")	70	405	609	RW1/164
"	675 (27")	70	436	685	RW1/190
"	750 (30")	70	468	762	RW1/191
75 dia	75 (3")	70	187	76	RW2/90
"	113 (4.5")	70	203	114	RW2/168
"	150 (6")	70	218	152	RW2/76
"	225 (9")	70	250	228	RW2/77
"	300 (12")	70	282	304	RW2/78
"	375 (15")	70	313	381	RW2/79
"	450 (18")	70	345	457	RW2/91
"	525 (21")	70	376	533	RW2/92
"	600 (24")	70	408	609	RW2/169
"	675 (27")	70	438	685	RW2/192
"	750 (30")	70	471	762	RW2/193
100 dia	75 (3")	69	205	76	RW3/118
"	113 (4.5")	69	221	114	RW3/171
"	150 (6")	69	236	152	RW3/119
"	225 (9")	69	268	228	RW3/120
"	300 (12")	69	300	304	RW3/121
"	375 (15")	69	331	381	RW3/122
"	450 (18")	69	363	457	RW3/123
"	525 (21")	69	394	533	RW3/124
"	600 (24")	69	426	609	RW3/172
"	675 (27")	69	457	685	RW3/194
"	750 (30")	69	489	762	RW3/195
150 dia	75 (3")	125	318	76	RW60/PO/3
"	150 (6")	125	334	152	RW60/PO/6
"	225 (9")	125	349	228	RW60/PO/9
"	300 (12")	125	413	304	RW60/PO/12
"	375 (15")	125	444	381	RW60/PO/15
"	450 (18")	125	476	457	RW60/PO/18
"	525 (21")	125	539	533	RW60/PO/21
"	600 (24")	125	570	609	RW60/PO/24

112.5° Two Part Offsets - Without Ears

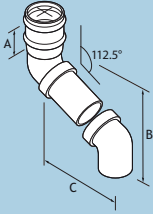

Pipe Size	Offset	A	B	C	Product Code
63 dia	225 (9")	70	247	229	RW1/350
"	375 (15")	70	310	381	RW1/351
"	450 (18")	70	342	457	RW1/352
"	675 (27")	70	436	685	RW1/353
"	900 (36")	70	529	914	RW1/354
75 dia	225 (9")	70	250	229	RW2/343
"	375 (15")	70	313	381	RW2/344
"	450 (18")	70	345	457	RW2/345
"	675 (27")	70	438	685	RW2/346
"	900 (36")	70	534	914	RW2/347

Note: See footer on page 39.

Heritage - Circular Pipes and Fittings

Shoes - With and Without Ears

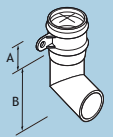
	Pipe Size	A	B	Product Code
	63 dia	55	105	RW1/66
	75 dia	64	112	RW2/80
	100 dia	69	135	RW3/125
	150 dia	125	215	RW60/SH
Note: The codes given above are for pipes with ears. For pipes without ears suffix codes with /NE				

Standard Base Clips

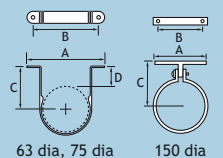
	Pipe Size	A	B	C	D	Product Code
	63 dia	124	100	65	33.5	RW1/236
	75 dia	137	112	71	33	RW2/237
	100 dia	163	138	90	39	RW3/238
	150 dia	255	215	121		RW60/PC

Extended Base Clips

	Pipe Size	A	B	C	Product Code
	63 dia	87	47	279	RW1/364
	75 dia	87	47	285	RW2/365
	100 dia	87	47	304	RW3/366

Small Base Clips

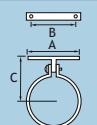
	Pipe Size	A	B	C	Product Code
	63 dia	87	47	74	RW1/SB/PC
	75 dia	87	47	80	RW2/SB/PC
	100 dia	87	47	92	RW3/SB/PC

Flat Back Rainwater Heads

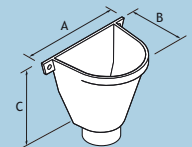
	Pipe Size	A	B	C	Product Code
	63 dia	194	168	184	RW1/72
	75 dia	194	168	184	RW2/86
	100 dia	194	168	184	RW3/131
Note: Designed to fit Heritage socketed aluminium pipes. Add suffix /F to product code to fit Flushjoint or Guardian pipes					

Rectangular Rainwater Heads

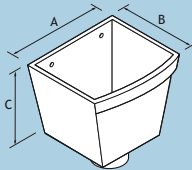
	Pipe Size	A	B	C	Product Code
	63 dia	258	190	178	RW1/111
	75 dia	258	190	178	RW2/112
	100 dia	258	190	178	RW3/113
Note: Designed to fit Heritage socketed aluminium pipes. Add suffix /F to product code to fit Flushjoint or Guardian pipes					

Ornamental Rainwater Heads

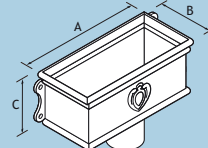
	Pipe Size	A	B	C	Product Code
	63 dia	410	186	178	RWOH/25
	75 dia	410	186	178	RWOH/30
	100 dia	410	186	178	RWOH/40
Note: Designed to fit Heritage socketed aluminium pipes. Add suffix /F to product code to fit Flushjoint or Guardian pipes					

Note: The products are available in a plain mill finish or with a BBA accredited polyester powder coated finish. Product codes in the tables refer to the mill finish. For polyester powder coated finish please add the suffix /PPC. Sundry items are not included as standard unless otherwise stated. Please order sundry items separately.

Heritage - Square and Rectangular Pipes and Fittings



Heritage square and rectangular pipes are available in 3 pipe sizes and 3 pipe lengths, together with a complete range of fittings. A spigot and socket system, which can be finished to replicate cast iron or with BBA certificated powder coatings in a choice of colours. Complementary rainwater heads available to suit.

Notes: Pipes and fittings are made using extruded section with welded-on cast sockets.

All dimensions are in mm unless shown otherwise.

Pipe sizes shown are nominal.

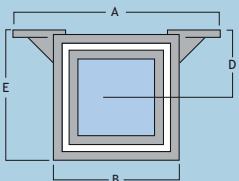
 <p>Note: All square and rectangular sockets are factory welded</p>	Sockets (Nominal)	75 x 75	100 x 75	100 x 100
	A Length of flange overall	162	190	190
B External width	90	122	122	
C Height of socket	82	85	85	
D Distance from centre line of pipe to wall	52	54	67	
E Distance from front of pipe to wall	98	102	130	

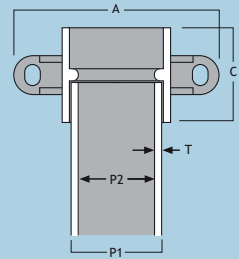
	Pipes (Nominal)	75 x 75	100 x 75	100 x 100
	P1 External Diameter	72 x 72	102 x 76	102 x 102
P2 Internal Diameter	68 x 68	98 x 72	97 x 97	
T Thickness	2.0	2.0	2.5	

Pipes - With and Without Ears

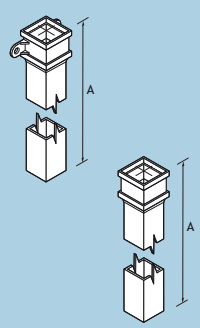
	Pipe Size	A	Product Code
	75 x 75 (3" x 3")	3000mm	RW33/3M
"	2000mm	RW33/2M	
"	1000mm	RW33/1M	
100 x 75 (4" x 3")	3000mm	RW43/3M	
"	2000mm	RW43/2M	
"	1000mm	RW43/1M	
100 x 100 (4" x 4")	3000mm	RW44/3M	
"	2000mm	RW44/2M	
"	1000mm	RW44/1M	

Note: The codes given above are for pipes with ears. For pipes without ears suffix codes with /NE

Note: The products are available in a plain mill finish or with a BBA accredited polyester powder coated finish. Product codes in the tables refer to the mill finish. For polyester powder coated finish please add the suffix /PPC. Sundry items are not included as standard unless otherwise stated. Please order sundry items separately.

Heritage - Square and Rectangular Pipes and Fittings

Bends - Front and Back

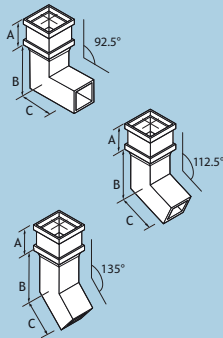
	Pipe Size	Bend	A	B	C	Product Code
	75 x 75	92.5 Degree	82	67	137	RW33/B/92
	100 x 75	"	85	80	150	RW43/FB/92
	100 x 100	"	85	81	151	RW44/B/92
	75 x 75	112.5 Degree	82	57	127	RW33/B/112
	100 x 75	"	85	66	136	RW43/FB/112
	100 x 100	"	85	66	136	RW44/B/112
	75 x 75	135 Degree	82	47	117	RW33/B/135
	100 x 75	"	85	58	128	RW43/FB/135
	100 x 100	"	85	53	123	RW44/B/135

Bends - Left and Right

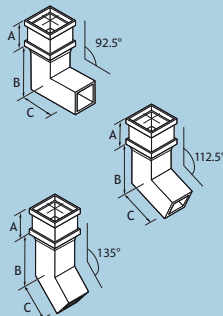
	Pipe Size	Bend	A	B	C	Product Code
	75 x 75	92.5 Degree	82	67	137	RW33/B/92
	100 x 75	"	85	80	150	RW43/SB/92
	100 x 100	"	85	81	151	RW44/B/92
	75 x 75	112.5 Degree	82	57	127	RW33/B/112
	100 x 75	"	85	66	136	RW43/SB/112
	100 x 100	"	85	66	136	RW44/B/112
	75 x 75	135 Degree	82	47	117	RW33/B/135
	100 x 75	"	85	58	128	RW43/SB/135
	100 x 100	"	85	53	123	RW44/B/135

Branches - Left and Right

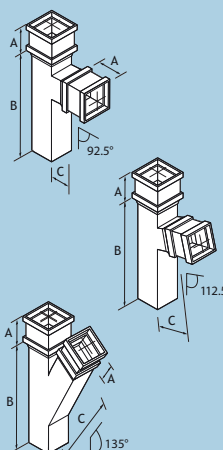
	Pipe Size	Branch	A	B	C	Product Code
	75 x 75	92.5 Degree	82	230	85	RW33/BR/92
	100 x 75	"	85	230	85	RW43/SBR/92
	100 x 100	"	85	230	85	RW44/BR/92
	75 x 75	112.5 Degree	82	248	118	RW33/BR/112
	100 x 75	"	85	248	118	RW43/SBR/112
	100 x 100	"	85	248	118	RW44/BR/112
	75 x 75	135 Degree	82	310	190	RW33/BR/135
	100 x 75	"	85	310	190	RW43/SBR/135
	100 x 100	"	85	310	190	RW44/BR/135

Note: 100x75 Front/Back Branches are also available. Product codes are as follows:
 RW43/FBR/92 for 92.5° Branches
 RW43/FBR/112 for 112.5° Branches
 RW43/FBR/135 for 135° Branches

Square Pipe Sockets

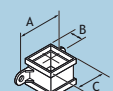
	Pipe Size	A	B	C	Product Code
	75 x 75	162	52	90	RW33/PS
	100 x 75	191	54	122	RW43/PS
	100 x 100	191	67	122	RW44/PS

Note: The codes given above are for sockets with ears. For sockets without ears suffix codes with /NE

Note: The products are available in a plain mill finish or with a BBA accredited polyester powder coated finish. Product codes in the tables refer to the mill finish. For polyester powder coated finish please add the suffix /PPC. Sundry items are not included as standard unless otherwise stated. Please order sundry items separately.

Heritage - Square and Rectangular Pipes and Fittings

Access Pipes

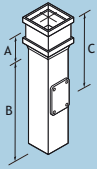
	Pipe Size	A	B	C	Product Code
	75 x 75	82	266	153	RW33/ACP
	100 x 75	82	266	153	RW43/ACP
	100 x 100	82	266	153	RW44/ACP

112.5° One Part Offsets

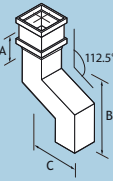
	Pipe Size	Offset	A	B	C	Product Code
	75 x 75	75 (3")	82	220	76	RW33/PO/3
	100 x 75	75 (3")	82	220	76	RW43/PO/3
	100 x 100	75 (3")	82	220	76	RW44/PO/3

Note: Alternative angles, e.g. 135° plinth offsets with ears are also available to order

112.5° Two Part Offsets

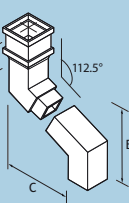
	Pipe Size	Offset	A	B	C	Product Code
	75 x 75	300 (12")	82	310	305	RW33/AO/12
	"	525 (21")	82	390	533	RW33/AO/21
	"	750 (30")	82	470	762	RW33/AO/30
	100 x 75	300 (12")	82	310	305	RW43/AO/12
	"	525 (21")	82	390	533	RW43/AO/21
	"	750 (30")	82	470	762	RW43/AO/30
	100 x 100	300 (12")	82	345	305	RW44/AO/12
	"	525 (21")	82	439	533	RW44/AO/21
	"	750 (30")	82	534	762	RW44/AO/30

Note: The order code for 112.5° side offsets should be suffixed with /L for left hand or /R for right hand discharge

Shoes Front with Ears

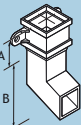
	Pipe Size	A	B	Product Code
	75 x 75	82	106	RW33/SH
	100 x 75	82	106	RW43/SH
	100 x 100	82	148	RW44/SH

Note: The codes given above are for shoes with ears. For shoes without ears add suffix /NE

Note: The products are available in a plain mill finish or with a BBA accredited polyester powder coated finish. Product codes in the tables refer to the mill finish. For polyester powder coated finish please add the suffix /PPC. Sundry items are not included as standard unless otherwise stated. Please order sundry items separately.

Heritage - Square and Rectangular Pipes and Fittings

Standard Base Clips

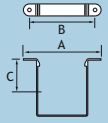
	Pipe Size	A	B	C	Product Code
	75 x 75	134	109	52	RW33/PC
	100 x 75	163	138	54	RW43/PC
	100 x 100	163	138	67	RW44/PC

Extended Base Clips

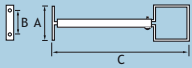
	Pipe Size	A	B	C	Product Code
	75 x 75	87	47	290 max	RW33/EX/PC
	100 x 75	87	47	292 max	RW43/EX/PC
	100 x 100	87	47	305 max	RW44/EX/PC

Small Base Clips

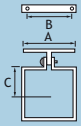
	Pipe Size	A	B	C	Product Code
	75 x 75	87	47	78	RW33/SB/PC
	100 x 75	87	47	80	RW43/SB/PC
	100 x 100	87	47	94	RW44/SB/PC

Rectangular Rainwater Heads

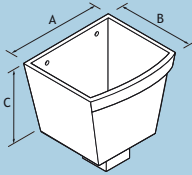
	Pipe Size	A	B	C	Product Code
	75 x 75	258	190	178	RW33/RH
	100 x 75	258	190	178	RW43/RH
	100 x 100	258	190	178	RW44/RH

NOTE: DESIGNED TO FIT HERITAGE SOCKETED ALUMINIUM PIPES. ADD SUFFIX /F TO PRODUCT CODE TO FIT FLUSHJOINT OR GUARDIAN PIPES

Ornamental Rainwater Heads

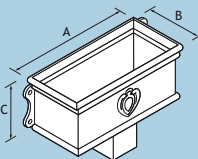
	Pipe Size	A	B	C	Product Code
	75 x 75	410	186	178	RWOH/33
	100 x 75	410	186	178	RWOH/43
	100 x 100	410	186	178	RWOH/44

NOTE: DESIGNED TO FIT HERITAGE SOCKETED ALUMINIUM PIPES. ADD SUFFIX /F TO PRODUCT CODE TO FIT FLUSHJOINT OR GUARDIAN PIPES



Note: The products are available in a plain mill finish or with a BBA accredited polyester powder coated finish. Product codes in the tables refer to the mill finish. For polyester powder coated finish please add the suffix /PPC. Sundry items are not included as standard unless otherwise stated. Please order sundry items separately.

Alumasc Rainwater Systems The Contemporary Aluminium Range

This premium, high performance rainwater range features the
Aqualine extruded aluminium gutter system,
GX pressed aluminium gutter system,
Flushjoint extruded aluminium pipe system and
Guardian extruded aluminium security pipe system.

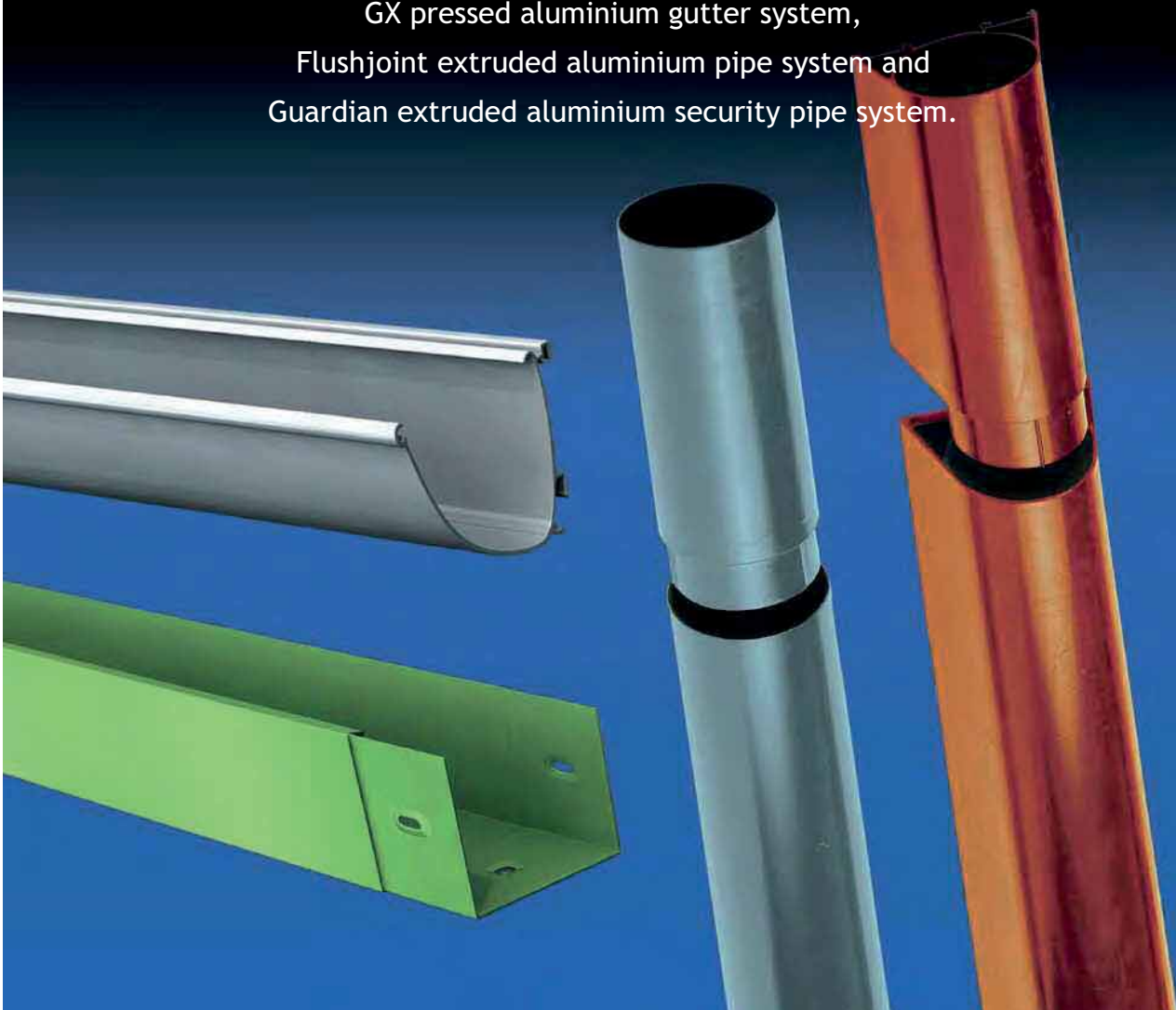

Contemporary Aluminium Rainwater Range - Introduction

Alumasc's contemporary range of aluminium rainwater systems are ideally suited for new build projects. The range consists of Aqualine Extruded and GX Pressed gutter systems along with corresponding downpipe systems of Flushjoint and the Guardian security downpipe system.



Aqualine - Extruded Aluminium Gutter Systems - Product Summary



Aqualine - Half Round Gutter



Aqualine - Deep Run Gutter



Aqualine - Modern Gutter



Aqualine - Moulded Gutter

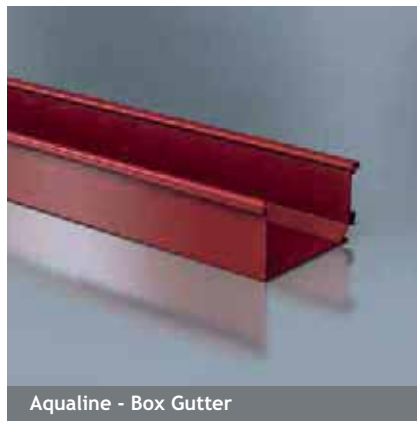

Aqualine - Box Gutter



Aqualine - Extruded Aluminium Gutter Systems - Product Summary

Aqualine provides a compact and efficient rainwater system that significantly enhances and complements the appearance and architectural character of the building. A choice of 5 standard profiles is available with secret fix bracketry and all weather 'dry' jointing, with full provision for thermal movement.

Applications

- Provides smooth lines and intricate detailing to contemporary designed buildings
- High flow capacity for enhanced performance
- Suited to both flush and projecting eaves applications

Features & Performance

- 5 gutter profiles available in 3 metre lengths, in a choice of sizes
- Designed to fully accommodate thermal movement at every joint
- Lightweight, durable and non-corrodible
- Life expectancy of aluminium: 40 years (rural/suburban areas); up to 25 years (industrial/marine areas)
- Easy to handle and fix
- Aqualine is patented and is also 'Design Registered'
- Aluminium is 100% recyclable

Colours & Finishes

- BBA approved polyester powder coatings, factory applied at Alumasc
- 26 standard colours with additional BS or RAL colours available to special order
- Also available in plain mill finish for on-site painting

Manufacture

- UK manufactured
- Based on aluminium extrusions to BS 1474: 1972, material 6063, T6

Installation & Fixing

- Concealed site fixing and jointing for a clean external appearance
- Once support brackets have been fixed to the building fabric all remaining assembly is by simple clip fix
- Joints are dry sealed using internal unions secured by sliding lock bars
- Minimal maintenance requirements



Gutter Profiles & Sizes



Half Round Gutter

100 x 50mm
120 x 60mm
150 x 75mm

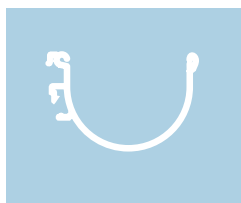

Deep Run Gutter

110 x 85mm



Modern Gutter

100 x 85mm
150 x 120mm



Moulded Gutter

140 x 100mm
160 x 100mm

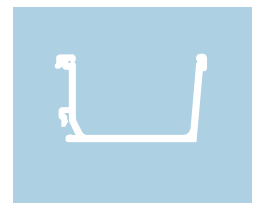

Box Gutter

120 x 80mm
140 x 100mm
160 x 100mm

Aqualine - Half Round Gutters and Fittings



Aqualine Half Round Gutters are available in 3 sizes and in standard 3m gutter lengths, together with a complete range of fittings. A contemporary profile with clean lines that fits well into virtually any design aesthetic. Factory finished in a choice of coloured BBA certificated powder coatings.

Notes: All dimensions are in mm unless shown otherwise.
Gutter sizes shown are nominal.

Gutter Assemblies

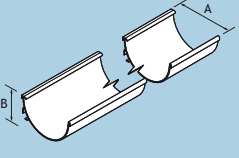
	Gutter Size	Gutter Length	A	B	T	Product Code
	100 x 50	3000mm	117	60	3	EHR10/3MA
	120 x 60	"	140	70	3	EHR12/3MA
	150 x 75	"	170	85	3	EHR15/3MA
Note: Gutter Assemblies are complete 3 metre assemblies including Gutter length, Union Clips, Brackets and Slide Locks T = Gutter Thickness (nominal)						

Union Clip Assemblies

	Gutter Size	A	Product Code
	100 x 50	76	EHR10/UCA
	120 x 60	76	EHR12/UCA
	150 x 75	76	EHR15/UCA
Note: Gutter Assemblies are supplied with Union Clips and Brackets included. The codes in the table are for additional items, ordered as extras Union Clip Assemblies include Union Clips and Slide Locks			

Brackets

	Gutter Size	A	B	Product Code
	100 x 50	40	70	EHR10/FB
	120 x 60	40	70	EHR12/FB
	150 x 75	40	80	EHR15/FB
Note: Gutter Assemblies are supplied with Union Clips and Brackets included. The codes in the table are for additional items, ordered as extras				

90° Angle Assemblies

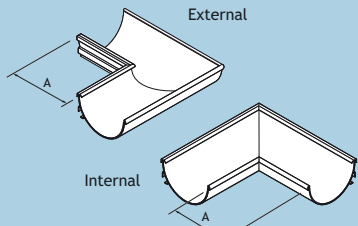
	Gutter Size	Type	A	Product Code
	100 x 50	External	200	EHR10/EA90A
	120 x 60	"	200	EHR12/EA90A
	150 x 75	"	200	EHR15/EA90A
	100 x 50	Internal	200	EHR10/IA90A
	120 x 60	"	200	EHR12/IA90A
	150 x 75	"	200	EHR15/IA90A
Note: Union Clip Assemblies include Union Clips and Slide Locks				

Note: The products are available in a plain mill finish or with a BBA accredited polyester powder coated finish. Product codes in the tables refer to the mill finish. For polyester powder coated finish please add the suffix /PPC. Sundry items are not included as standard unless otherwise stated. Please order sundry items separately.

Aqualine - Half Round Gutters and Fittings

135° Angle Assemblies

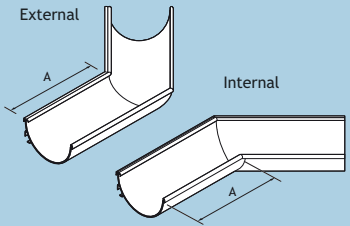
	Gutter Size	Type	A	Product Code
	External	100 x 50	External	200
	120 x 60	"	200	EHR12/EA13A
	150 x 75	"	200	EHR15/EA13A
Internal	100 x 50	Internal	200	EHR10/IA13A
	120 x 60	"	200	EHR12/IA13A
	150 x 75	"	200	EHR15/IA13A

Note: Union Clip Assemblies include Union Clips and Slide Locks

Running Outlet Assemblies

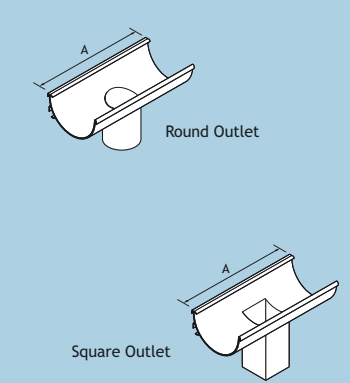
	Gutter Size	Pipe Size	A	Product Code
	Round Outlet	100 x 50	63 dia	300
	120 x 60	"	300	EHR12/RO25A
	150 x 75	"	300	EHR15/RO25A
	100 x 50	75 dia	300	EHR10/RO30A
	120 x 60	"	300	EHR12/RO30A
	150 x 75	"	300	EHR15/RO30A
	100 x 75	100 dia	300	EHR15/RO40A
Square Outlet	100 x 50	75 x 75	300	EHR10/SO33A
	120 x 60	"	300	EHR12/SO33A
	150 x 75	"	300	EHR15/SO33A
	100 x 50	100 x 75	300	EHR10/SO43A
	120 x 60	"	300	EHR12/SO43A
	150 x 75	"	300	EHR15/SO43A
	150 x 75	100 x 100	300	EHR15/SO44A

Note: A choice of three pipe systems is available. Product codes above denote that running outlets fit to Heritage socketed aluminium pipes. ADD SUFFIX /F TO PRODUCT CODE TO FIT FLUSHJOINT OR GUARDIAN PIPES
 Union Clip Assemblies include Union Clips and Slide Locks

Stop-End Assemblies

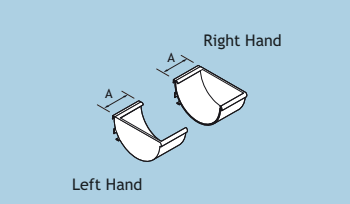
	Gutter Size	Type	A	Product Code
	Right Hand	100 x 50	Left Hand	50
	120 x 60	"	50	EHR12/SELHA
	150 x 75	"	50	EHR15/SELHA
Left Hand	100 x 50	Right Hand	50	EHR10/SERHA
	120 x 60	"	50	EHR12/SERHA
	150 x 75	"	50	EHR15/SERHA

Note: Union Clip Assemblies include Union Clips and Slide Locks

Starter Pack (required with each order)

Includes: P80 joint/seal lubricant. 2 x jointing tool. 10 x spare lock bars. 20 x spare No 12 screws. 8 x spare seal strips. 20 x shims.	Gutter Size	Product Code
		100 x 50
	120 x 60	EHR12/START
	150 x 75	EHR15/START

Note: The products are available in a plain mill finish or with a BBA accredited polyester powder coated finish. Product codes in the tables refer to the mill finish. For polyester powder coated finish please add the suffix /PPC. Sundry items are not included as standard unless otherwise stated. Please order sundry items separately.

Aqualine - Deep Run Gutters and Fittings



Aqualine Deep Run Gutters combine the clean lines of a modern half round gutter with high capacity and extra performance. Available in 1 size and in standard 3m gutter lengths, together with a complete range of fittings. Factory finished in a choice of coloured BBA certificated powder coatings.

Notes: All dimensions are in mm unless shown otherwise.
Gutter sizes shown are nominal.

Gutter Assemblies

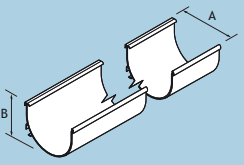
	Gutter Size	Gutter Length	A	B	T	Product Code
		110 x 85	3000mm	137	88	3
Note: Gutter Assemblies are complete 3 metre assemblies including Gutter length, Union Clips, Brackets and Slide Locks T = Gutter Thickness (nominal)						

Union Clip Assemblies

	Gutter Size	A	Product Code
		110 x 85	76
Note: Gutter Assemblies are supplied with Union Clips and Brackets included. The codes in the table are for additional items, ordered as extras Union Clip Assemblies include Union Clips and Slide Locks			

Brackets

	Gutter Size	A	B	Product Code
		110 x 85	40	80
Note: Gutter Assemblies are supplied with Union Clips and Brackets included. The codes in the table are for additional items, ordered as extras				

90° Angle Assemblies

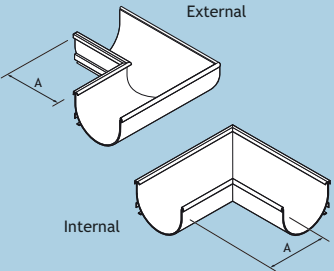
	Gutter Size	Type	A	Product Code	
		110 x 85	External	200	EDR11/EA90A
		110 x 85	Internal	200	EDR11/IA90A
Note: Union Clip Assemblies include Union Clips and Slide Locks					

Note: The products are available in a plain mill finish or with a BBA accredited polyester powder coated finish. Product codes in the tables refer to the mill finish. For polyester powder coated finish please add the suffix /PPC. Sundry items are not included as standard unless otherwise stated. Please order sundry items separately.

Aqualine - Deep Run Gutters and Fittings

135° Angle Assemblies

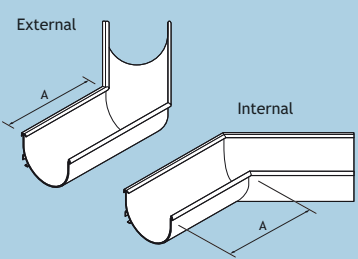
	Gutter Size	Type	A	Product Code
	110 x 85	External	200	EDR11/EA13A
	110 x 85	Internal	200	EDR11/IA13A

Note: Union Clip Assemblies include Union Clips and Slide Locks

Running Outlet Assemblies

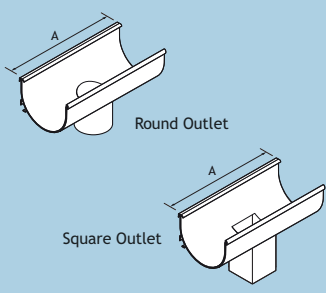
	Gutter Size	Pipe Size	A	Product Code
	110 x 85	63 dia	300	EDR11/RO25A
	110 x 85	75 dia	300	EDR11/RO30A
	110 x 85	100 dia	300	EDR11/RO40A
	110 x 85	75 x 75	300	EDR11/SO33A
	110 x 85	100 x 75	300	EDR11/SO43A
	110 x 85	100 x 100	300	EDR11/SO44A

Note: A choice of three pipe systems is available. Product codes above denote that running outlets fit to Heritage socketed aluminium pipes. ADD SUFFIX /F TO PRODUCT CODE TO FIT FLUSHJOINT OR GUARDIAN PIPES
 Union Clip Assemblies include Union Clips and Slide Locks

Stop-End Assemblies

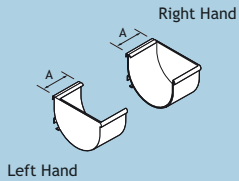
	Gutter Size	Type	A	Product Code
	110 x 85	Left Hand	50	EDR11/SELHA
	110 x 85	Right Hand	50	EDR11/SERHA

Note: Union Clip Assemblies include Union Clips and Slide Locks

Starter Pack (required with each order)

Includes: P80 joint/seal lubricant. 2 x jointing tool. 10 x spare lock bars. 20 x spare No 12 screws. 8 x spare seal strips. 20 x shims.	Gutter Size	Product Code
	110 x 85	EDR11/START



Note: The products are available in a plain mill finish or with a BBA accredited polyester powder coated finish. Product codes in the tables refer to the mill finish. For polyester powder coated finish please add the suffix /PPC. Sundry items are not included as standard unless otherwise stated. Please order sundry items separately.

Aqualine - Modern Gutters and Fittings



Aqualine Modern Gutters are available in 2 sizes and in standard 3m gutter lengths, together with a complete range of fittings. Sophisticated contemporary appearance for striking visual detail at the roofline. Factory finished in a choice of coloured BBA certificated powder coatings.

Notes: All dimensions are in mm unless shown otherwise.
Gutter sizes shown are nominal.

Gutter Assemblies

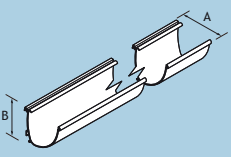
	Gutter Size	Gutter Length	A	B	T	Product Code
	100 x 85	3000mm	122	104	3	EAQ10/3MA
	150 x 120	"	170	135	3	EAQ15/3MA
Note: Gutter Assemblies are complete 3 metre assemblies including Gutter length, Union Clips, Brackets and Slide Locks T = Gutter Thickness (nominal)						

Union Clip Assemblies

	Gutter Size	A	Product Code
	100 x 85	76	EAQ10/UCA
	150 x 120	76	EAQ15/UCA
Note: Gutter Assemblies are supplied with Union Clips and Brackets included. The codes in the table are for additional items, ordered as extras Union Clip Assemblies include Union Clips and Slide Locks			

Brackets

	Gutter Size	A	B	Product Code
	100 x 85	40	92	EAQ10/FB
	150 x 120	40	88	EAQ15/FB
Note: Gutter Assemblies are supplied with Union Clips and Brackets included. The codes in the table are for additional items, ordered as extras				

90° Angle Assemblies

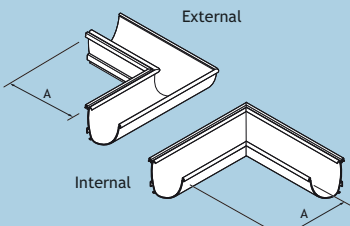
	Gutter Size	Type	A	Product Code
	100 x 85	External	200	EAQ10/EA90A
	150 x 120	"	200	EAQ15/EA90A
	100 x 85	Internal	200	EAQ10/IA90A
	150 x 120	"	200	EAQ15/IA90A
Note: Union Clip Assemblies include Union Clips and Slide Locks				

Note: The products are available in a plain mill finish or with a BBA accredited polyester powder coated finish. Product codes in the tables refer to the mill finish. For polyester powder coated finish please add the suffix /PPC. Sundry items are not included as standard unless otherwise stated. Please order sundry items separately.

Aqualine - Modern Gutters and Fittings

135° Angle Assemblies

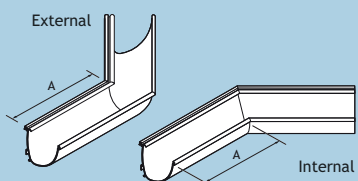
	Gutter Size	Type	A	Product Code
	100 x 85	External	200	EAQ10/EA13A
	150 x 120	"	200	EAQ15/EA13A
	100 x 85	Internal	200	EAQ10/IA13A
	150 x 120	"	200	EAQ15/IA13A

Note: Union Clip Assemblies include Union Clips and Slide Locks

Running Outlets Assemblies

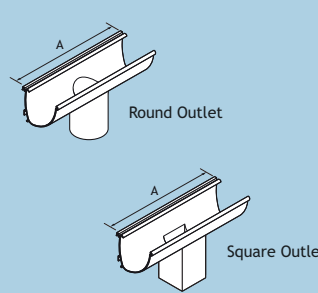
	Gutter Size	Pipe Size	A	Product Code
	100 x 85	63 dia	300	EAQ10/RO25A
	150 x 120	"	300	EAQ15/RO25A
	100 x 85	75 dia	300	EAQ10/RO30A
	150 x 120	"	300	EAQ15/RO30A
	150 x 120	100 dia	300	EAQ15/RO40A
	100 x 85	75 x 75	300	EAQ10/SO33A
	150 x 120	"	300	EAQ15/SO33A
	100 x 85	100 x 75	300	EAQ10/SO43A
	150 x 120	"	300	EAQ15/SO43A
	150 x 120	100 x 100	300	EAQ15/SO44A

Note: A choice of three pipe systems is available. Product codes above denote that running outlets fit to Heritage socketed aluminium pipes. ADD SUFFIX /F TO PRODUCT CODE TO FIT FLUSHJOINT OR GUARDIAN PIPES
Union Clip Assemblies include Union Clips and Slide Locks

Stop-End Assemblies

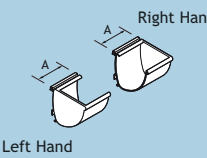
	Gutter Size	Type	A	Product Code
	100 x 85	Left Hand	50	EAQ10/SELHA
	150 x 120	"	50	EAQ15/SELHA
	100 x 85	Right Hand	50	EAQ10/SERHA
	150 x 120	"	50	EAQ15/SERHA

Note: Union Clip Assemblies include Union Clips and Slide Locks

Starter Pack (required with each order)

Includes: P80 joint/seal lubricant. 2 x jointing tool. 10 x spare lock bars. 20 x spare No 12 screws. 8 x spare seal strips. 20 x shims.	Gutter Size	Product Code
	100 x 85	EAQ10/START
	150 x 120	EAQ15/START



Note: The products are available in a plain mill finish or with a BBA accredited polyester powder coated finish. Product codes in the tables refer to the mill finish. For polyester powder coated finish please add the suffix /PPC. Sundry items are not included as standard unless otherwise stated. Please order sundry items separately.

Aqualine - Moulded Gutters and Fittings



Aqualine Moulded Gutters are available in 2 sizes and in standard 3m gutter lengths, together with a complete range of fittings. A classic moulded profile in a state-of-the-art contemporary gutter system. Factory finished in a choice of coloured BBA certificated powder coatings.

Notes: All dimensions are in mm unless shown otherwise.
Gutter sizes shown are nominal.

Gutter Assemblies

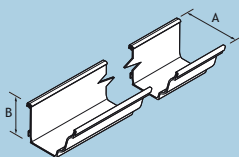
	Gutter Size	Gutter Length	A	B	T	Product Code
	140 x 100	3000mm	165	103	3	EMG14/3MA
	160 x 100	"	187	103	3	EMG16/3MA
Note: Gutter Assemblies are complete 3 metre assemblies including Gutter length, Union Clips, Brackets and Slide Locks T = Gutter Thickness (nominal)						

Union Clip Assemblies

	Gutter Size	A	Product Code
	140 x 100	76	EMG14/UCA
	160 x 100	76	EMG16/UCA
Note: Gutter Assemblies are supplied with Union Clips and Brackets included. The codes in the table are for additional items, ordered as extras Union Clip Assemblies include Union Clips and Slide Locks			

Brackets

	Gutter Size	A	B	Product Code
	140 x 100	40	92	EMG14/FB
	160 x 100	40	92	EMG16/FB
Note: Gutter Assemblies are supplied with Union Clips and Brackets included. The codes in the table are for additional items, ordered as extras				

90° Angle Assemblies

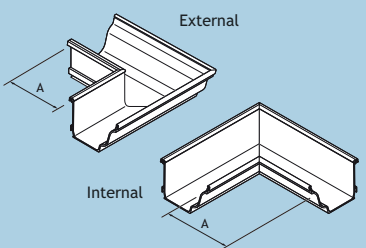
	Gutter Size	Type	A	Product Code
	140 x 100	External	200	EMG14/EA90A
	160 x 100	"	200	EMG16/EA90A
	140 x 100	Internal	200	EMG14/IA90A
	160 x 100	"	200	EMG16/IA90A
Note: Union Clip Assemblies include Union Clips and Slide Locks				

Note: The products are available in a plain mill finish or with a BBA accredited polyester powder coated finish. Product codes in the tables refer to the mill finish. For polyester powder coated finish please add the suffix /PPC. Sundry items are not included as standard unless otherwise stated. Please order sundry items separately.

Aqualine - Moulded Gutters and Fittings

135° Angle Assemblies

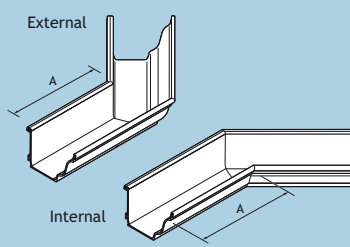
	Gutter Size	Type	A	Product Code
	140 x 100	External	200	EMG14/EA13A
	160 x 100	"	200	EMG16/EA13A
	140 x 100	Internal	200	EMG14/IA13A
	160 x 100	"	200	EMG16/IA13A
Note: Union Clip Assemblies include Union Clips and Slide Locks				

Running Outlet Assemblies

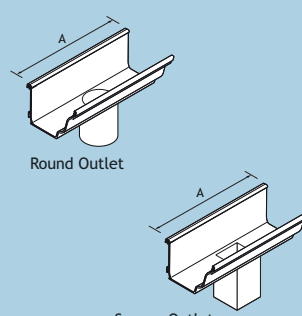
	Gutter Size	Pipe Size	A	Product Code
	140 x 100	63 dia	300	EMG14/RO25A
	160 x 100	"	300	EMG16/RO25A
	140 x 100	75 dia	300	EMG14/RO30A
	160 x 100	"	300	EMG16/RO30A
	160 x 100	100 dia	300	EMG16/RO40A
	140 x 100	75 x 75	300	EMG14/SO33A
	160 x 100	"	300	EMG16/SO33A
	140 x 100	100 x 75	300	EMG14/SO43A
	160 x 100	"	300	EMG16/SO43A
160 x 100	100 x 100	300	EMG16/SO44A	
Note: A choice of three pipe systems is available. Product codes above denote that running outlets fit to Heritage socketed aluminium pipes. ADD SUFFIX /F TO PRODUCT CODE TO FIT FLUSHJOINT OR GUARDIAN PIPES Union Clip Assemblies include Union Clips and Slide Locks				

Stop-End Assemblies

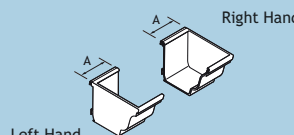
	Gutter Size	Type	A	Product Code
	140 x 100	Left Hand	50	EMG14/SELHA
	160 x 100	"	50	EMG16/SELHA
	140 x 100	Right Hand	50	EMG14/SERHA
	160 x 100	"	50	EMG16/SERHA
Note: Union Clip Assemblies include Union Clips and Slide Locks				

Starter Pack (required with each order)

Includes: P80 joint/seal lubricant. 2 x jointing tool. 10 x spare lock bars. 20 x spare No 12 screws. 8 x spare seal strips. 20 x shims.	Gutter Size	Product Code
	140 x 100	EMG14/START
	160 x 100	EMG16/START

Note: The products are available in a plain mill finish or with a BBA accredited polyester powder coated finish. Product codes in the tables refer to the mill finish. For polyester powder coated finish please add the suffix /PPC. Sundry items are not included as standard unless otherwise stated. Please order sundry items separately.

Aqualine - Box Gutters and Fittings



Aqualine Box Gutters are available in 3 sizes and in standard 3m gutter lengths, together with a complete range of fittings. Pronounced angular lines make a strong visual statement. Factory finished in a choice of coloured BBA certificated powder coatings.

Notes: All dimensions are in mm unless shown otherwise.
Gutter sizes shown are nominal.

Gutter Assemblies

	Gutter Size	Gutter Length	A	B	T	Product Code
	120 x 80	3000mm	145	83	3	EBG12/3MA
	140 x 100	"	162	103	3	EBG14/3MA
	160 x 100	"	183	103	3	EBG16/3MA
Note: Gutter Assemblies are complete 3 metre assemblies including Gutter length, Union Clips, Brackets and Slide Locks T = Gutter Thickness (nominal)						

Union Clip Assemblies

	Gutter Size	A	Product Code
	120 x 80	76	EBG12/UCA
	140 x 100	76	EBG14/UCA
	160 x 100	76	EBG16/UCA
Note: Gutter Assemblies are supplied with Union Clips and Brackets included. The codes in the table are for additional items, ordered as extras Union Clip Assemblies include Union Clips and Slide Locks			

Brackets

	Gutter Size	A	B	Product Code
	120 x 80	40	88	EBG12/FB
	140 x 100	40	92	EBG14/FB
	160 x 100	40	92	EBG16/FB
Note: Gutter Assemblies are supplied with Union Clips and Brackets included. The codes in the table are for additional items, ordered as extras				

90° Angle Assemblies

	Gutter Size	Type	A	Product Code
	120 x 80	External	200	EBG12/EA90A
	140 x 100	"	200	EBG14/EA90A
	160 x 100	"	200	EBG16/EA90A
	120 x 80	Internal	200	EBG12/IA90A
	140 x 100	"	200	EBG14/IA90A
	160 x 100	"	200	EBG16/IA90A
	Note: Union Clip Assemblies include Union Clips and Slide Locks			

Note: The products are available in a plain mill finish or with a BBA accredited polyester powder coated finish. Product codes in the tables refer to the mill finish. For polyester powder coated finish please add the suffix /PPC. Sundry items are not included as standard unless otherwise stated. Please order sundry items separately.

Aqualine - Box Gutters and Fittings

135° Angle Assemblies

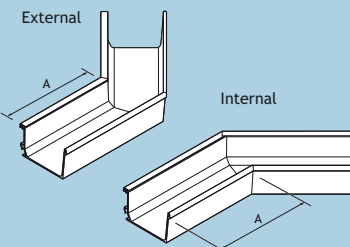
	Gutter Size	Type	A	Product Code
	120 x 80	External	200	EBG12/EA13A
140 x 100	"	200	EBG14/EA13A	
160 x 100	"	200	EBG16/EA13A	
120 x 80	Internal	200	EBG12/IA13A	
140 x 100	"	200	EBG14/IA13A	
160 x 100	"	200	EBG16/IA13A	

Note: Union Clip Assemblies include Union Clips and Slide Locks

Running Outlet Assemblies

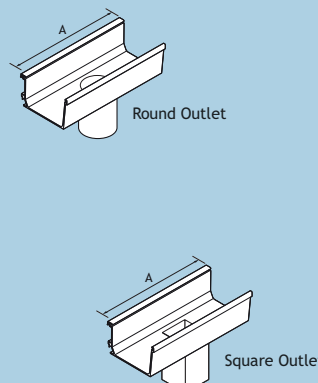
	Gutter Size	Pipe Size	A	Product Code
	120 x 80	63 dia	300	EBG12/RO25A
140 x 100	"	300	EBG14/RO25A	
160 x 100	"	300	EBG16/RO25A	
120 x 80	75 dia	300	EBG12/RO30A	
140 x 100	"	300	EBG14/RO30A	
160 x 100	"	300	EBG16/RO30A	
140 x 100	100 dia	300	EBG14/RO40A	
160 x 100	"	300	EBG16/RO40A	
120 x 80	75 x 75	300	EBG12/SO33A	
140 x 100	"	300	EBG14/SO33A	
160 x 100	"	300	EBG16/SO33A	
120 x 80	100 x 75	300	EBG12/SO43A	
140 x 100	"	300	EBG14/SO43A	
160 x 100	"	300	EBG16/SO43A	
140 x 100	100 x 100	300	EBG14/SO44A	
160 x 100	"	300	EBG16/SO44A	

Note: A choice of three pipe systems is available. Product codes above denote that running outlets fit to Heritage socketed aluminium pipes. ADD SUFFIX /F TO PRODUCT CODE TO FIT FLUSHJOINT OR GUARDIAN PIPES
 Union Clip Assemblies include Union Clips and Slide Locks

Stop-End Assemblies

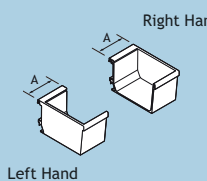
	Gutter Size		A	Product Code
	120 x 80	Left Hand	50	EBG12/SELHA
140 x 100	"	50	EBG14/SELHA	
160 x 100	"	50	EBG16/SELHA	
120 x 80	Right Hand	50	EBG12/SERHA	
140 x 100	"	50	EBG14/SERHA	
160 x 100	"	50	EBG16/SERHA	

Note: Union Clip Assemblies include Union Clips and Slide Locks

Starter Pack (required with each order)

Includes: P80 joint/seal lubricant. 2 x jointing tool. 10 x spare lock bars. 20 x spare No 12 screws. 8 x spare seal strips. 20 x shims.	Gutter	Product Code
	120 x 80	EBG12/START
140 x 100	EBG14/START	
160 x 100	EBG16/START	

Note: The products are available in a plain mill finish or with a BBA accredited polyester powder coated finish. Product codes in the tables refer to the mill finish. For polyester powder coated finish please add the suffix /PPC. Sundry items are not included as standard unless otherwise stated. Please order sundry items separately.

AX - Extruded Aluminium Gutter Systems - Product Summary



AX - Half Round Gutter



AX - Deep Run Gutter

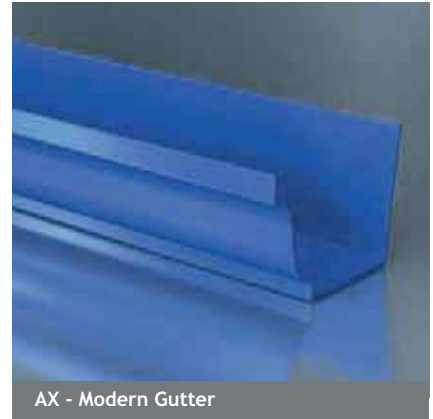

AX - Modern Gutter



AX - Extruded Aluminium Gutter Systems - Product Summary

An economical range of extruded aluminium gutter sections designed for traditional wet jointing on site. AX gutters are available in 3 profiles and a choice of sizes - ideal where a high capacity gutter system is required.

Applications

- High capacity gutters for traditional or modern buildings
- Suited to both flush and projecting eaves applications
- Long-life alternative of PVC gutters

Features & Performance

- 3 gutter profiles available in 3 metre length in a choice of sizes
- Designed to fully accommodate thermal movement at every joint
- Lightweight, durable and highly corrosion resistant
- Life expectancy of aluminium: 40 years (rural/suburban areas); up to 25 years (industrial/marine areas)
- Easy to handle and fix
- Aluminium is 100% recyclable

Colours & Finishes

- BBA approved polyester powder coatings, factory applied at Alumasc
- 26 standard colours with additional BS or RAL colours available to special order
- Also available in plain mill finish for on-site painting

Manufacture

- UK manufactured under ISO 9001 and ISO 14001 factory certified conditions
- Based on aluminium extrusions to BS 1474:1972, material 6063, T6

Installation & Fixing

- Wet-sealed and bolted joints - very simple, well-proven method
- Gutter joints are secured with screws or bolts through integral holes/slots
- Fixed by brackets as well as an option to direct-fix for the moulded profile
- Minimal maintenance requirements

Gutter Profiles & Sizes



Half Round
112mm
125mm
150mm



Deep Run
125 x 100mm



Moulded
100 x 75mm
125 x 100mm
150 x 100mm
200 x 150mm



AX - Half Round Gutters and Fittings



AX Half Round Gutters are available in 3 sizes in standard 3m gutter lengths, together with a complete range of fittings. A contemporary profile that incorporates well into virtually any design, traditional or contemporary. Factory finished in a choice of BBA approved polyester powder coatings.

Notes: All dimensions are in mm unless shown otherwise.
Gutter sizes shown are nominal.

Gutter Assemblies

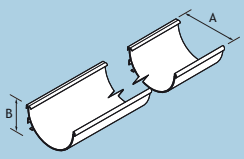
	Gutter Size	Gutter Length	A	B	T	Product Code
	112	3000mm	112	60	3	AXBH11/3MA
	125	"	125	70	3	AXBH12/3MA
	150	"	150	85	3	AXBH15/3MA
	112	1000mm	112	60	3	AXBH11/1MA
	125	"	125	70	3	AXBH12/1MA
	150	"	150	85	3	AXBH15/1MA

Note: Gutter Assemblies are complete 3 metre assemblies including Gutter length, Union Clips, Brackets and Slide Locks
T = Gutter Thickness (nominal)

Union Clip Assemblies

	Gutter Size	A	Product Code
	112	76	AXBH11/UCA
	125	76	AXBH12/UCA
	150	76	AXBH15/UCA

Note: Gutter Assemblies are supplied with Union Clips and Brackets included. The codes in the table are for additional items, ordered as extras
Union Clip Assemblies include Union Clips and Slide Locks

Brackets

	Gutter Size	Type	A	B	Product Code
	112	Fascia	30	70	AXBH11/FB
	125	"	30	70	AXBH12/FB
	150	"	30	80	AXBH15/FB
	112	Top Fix	30	70	AXBH11/RB/TF
	125	"	30	70	AXBH12/RB/TF
	150	"	30	80	AXBH15/RB/TF
	112	Side Fix	30	70	AXBH11/RB/SF
	125	"	30	70	AXBH12/RB/SF
	150	"	30	80	AXBH15/RB/SF
	112	Rise and Fall	30	70	AXBH11/R&F/ASSY
	125	"	30	70	AXBH12/R&F/ASSY
	150	"	30	80	AXBH15/R&F/ASSY

Note: Gutter Assemblies are supplied with Union Clips and Brackets included. The codes in the table are for additional items, ordered as extras

Note: See footer on page 61.

AX - Half Round Gutters and Fittings

90° Angle Assemblies

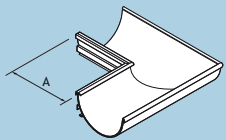
	Gutter Size		A	Product Code
	112	100	100	AXBH11/90A
	125	100	100	AXBH12/90A
	150	100	100	AXBH15/90A

135° Angle Assemblies

	Gutter Size		A	Product Code
	112	100	100	AXBH11/135A
	125	100	100	AXBH12/135A
	150	100	100	AXBH15/135A

Note: Union Clip Assemblies include Union Clips and Slide Locks

Running Outlet Assemblies

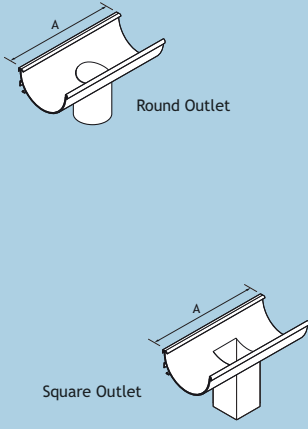
	Gutter Size		Pipe Size	A	Product Code
	112	125	63 dia	300	AXBH11/RO25A
	125	150	"	300	AXBH12/RO25A
	150	112	"	300	AXBH15/RO25A
	112	125	76 dia	300	AXBH11/RO30A
	125	150	"	300	AXBH12/RO30A
	150	112	"	300	AXBH15/RO30A
	125	125	102 dia	300	AXBH12/RO40A
	150	112	"	300	AXBH15/RO40A
	112	125	75 x 75	300	AXBH11/SO33A
	125	150	"	300	AXBH12/SO33A
	150	112	"	300	AXBH15/SO33A
	112	125	100 x 75	300	AXBH11/SO43A
	125	150	"	300	AXBH12/SO43A
	150	112	"	300	AXBH15/SO43A
	125	125	100 x 100	300	AXBH12/SO44A
150	112	"	300	AXBH15/SO44A	

Note: A choice of three pipe systems is available. Product codes above denote that running outlets fit to Heritage socketed aluminium pipes. ADD SUFFIX /F TO PRODUCT CODE TO FIT FLUSHJOINT OR GUARDIAN PIPES
Union Clip Assemblies include Union Clips and Slide Locks

Stop-End Assemblies

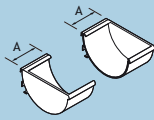
	Gutter Size		A	Product Code
	112	125	50	AXH11/SEA
	125	150	50	AXH12/SEA
	150	112	50	AXH15/SEA

Note: Union Clip Assemblies include Union Clips and Slide Locks

Note: The products are available in a plain mill finish or with a BBA accredited polyester powder coated finish. Product codes in the tables refer to the mill finish. For polyester powder coated finish please add the suffix /PPC. Sundry items are not included as standard unless otherwise stated. Please order sundry items separately.

AX - Beaded Deep Run Gutters and Fittings



AX Beaded Deep Run Gutters combine economy and efficiency where a high capacity gutter and extra performance is required. Available in one size and in standard 3m gutter lengths, together with a complete range of fittings. Factory finished in a choice of BBA approved polyester powder coatings.

Notes: All dimensions are in mm unless shown otherwise.
Gutter sizes shown are nominal.

Gutter Assemblies

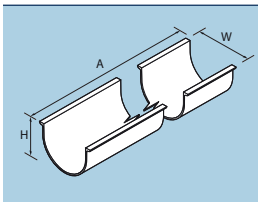

Gutter Size	Gutter Length	A	B	T	Product Code
125 x 100	3000mm	125	100	3	AXDR12/3MA
125 x 100	1000mm	125	100	3	AXDR12/1MA

Note: Gutter Assemblies are complete 3 metre assemblies including Gutter length, Union Clips, Brackets and Slide Locks
T = Gutter Thickness (nominal)

Union Clip Assemblies

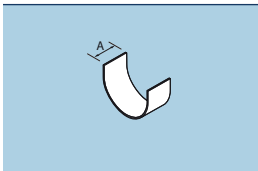

Gutter Size	A	Product Code
125 x 100	76	AXDR12/UCA

Note: Gutter Assemblies are supplied with Union Clips and Brackets included. The codes in the table are for additional items, ordered as extras
Union Clip Assemblies include Union Clips and Slide Locks

Brackets

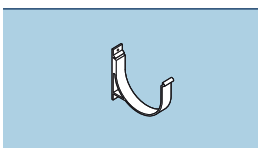

Gutter Size	Type	A	B	Product Code
125 x 100	Fascia	30		AXDR12/FB

Note: Gutter Assemblies are supplied with Union Clips and Brackets included. The codes in the table are for additional items, ordered as extras

90° Angle Assemblies

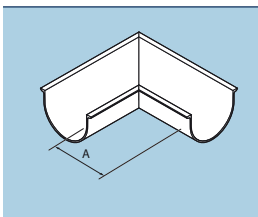

Gutter Size	A	Product Code
125 x 100	100	AXDR12/90A

Note: Union Clip Assemblies include Union Clips and Slide Locks

Note: The products are available in a plain mill finish or with a BBA accredited polyester powder coated finish. Product codes in the tables refer to the mill finish. For polyester powder coated finish please add the suffix /PPC. Sundry items are not included as standard unless otherwise stated. Please order sundry items separately.

AX - Beaded Deep Run Gutters and Fittings

135° Angle Assemblies

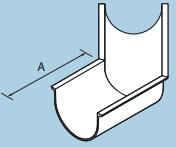
	Gutter Size	A	Product Code
		125 x 100	100
Note: Union Clip Assemblies include Union Clips and Slide Locks			

Running Outlet Assemblies

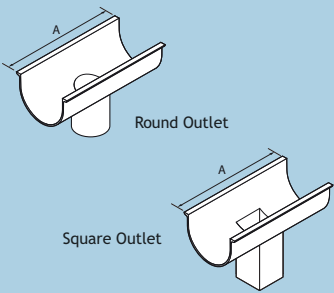
	Gutter Size	Pipe Size	A	Product Code
	125 x 100	63 dia	300	AXDR12/RO25A
	125 x 100	76 dia	300	AXDR12/RO30A
	125 x 100	103 dia	300	AXDR12/RO40A
	125 x 100	76 x 76	300	AXDR12/SO33A
	125 x 100	100 x 75	300	AXDR12/SO43A
	125 x 100	100 x 100	300	AXDR12/SO44A
Note: A choice of three pipe systems is available. Product codes above denote that running outlets fit to Heritage socketed aluminium pipes. ADD SUFFIX /F TO PRODUCT CODE TO FIT FLUSHJOINT OR GUARDIAN PIPES Union Clip Assemblies include Union Clips and Slide Locks				

Stop-End Assemblies

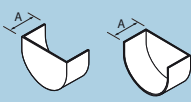
	Gutter Size	A	Product Code
	125 x 100	50	AXDR12/SEA
Note: Union Clip Assemblies include Union Clips and Slide Locks			

Note: The products are available in a plain mill finish or with a BBA accredited polyester powder coated finish. Product codes in the tables refer to the mill finish. For polyester powder coated finish please add the suffix /PPC. Sundry items are not included as standard unless otherwise stated. Please order sundry items separately.

AX - Moulded Gutters and Fittings



AX Moulded Gutters offer economy and practicality with a classic profile in a contemporary gutter system. Available in four sizes and in standard 3m gutter lengths, together with a complete range of fittings. Factory finished in a choice of BBA approved polyester powder coatings.

Notes: All dimensions are in mm unless shown otherwise.
Gutter sizes shown are nominal.

Gutter Assemblies

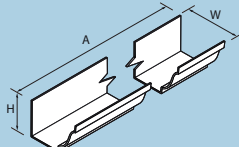
	Gutter Size	Gutter Length	A	B	T	Product Code
<p>Note: Gutter Assemblies are complete 3 metre assemblies including Gutter length, Union Clips.</p> <p>T = Gutter Thickness (nominal)</p>	100 x 75	3000mm	100	75	3	AXMG10/3MA
	125 x 100	"	125	100	3	AXMG12/3MA
	150 x 100	"	150	100	3	AXMG15/3MA
	200 x 150	"	200	150	3	AXMG20/3MA
	100 x 75	1000mm	100	75	3	AXMG10/1MA
	125 x 100	"	125	100	3	AXMG12/1MA
	150 x 100	"	150	100	3	AXMG15/1MA
	200 x 150	"	200	150	3	AXMG20/1MA

Union Clip Assemblies

	Gutter Size	A	Product Code
<p>Note: Gutter Assemblies are supplied with Union Clips. The codes in the table are for additional items, ordered as extras.</p>	100 x 75	76	AXMG10/UCA
	125 x 100	76	AXMG12/UCA
	150 x 100	76	AXMG15/UCA
	200 x 150	76	AXMG20/UCA

Brackets

	Gutter Size	Type	A	B	Product Code
	100 x 75	Fascia	30		AXMG10/FB
	125 x 100	"	30		AXMG12/FB
	150 x 100	"	30		AXMG15/FB
	200 x 150	"	30		AXMG20/FB
	100 x 75	Top Fix	30		AXMG10/RB/TF
	125 x 100	"	30		AXMG12/RB/TF
	150 x 100	"	30		AXMG15/RB/TF
	100 x 75	Side Fix	30		AXMG10/RB/SF
	125 x 100	"	30		AXMG12/RB/SF
	150 x 100	"	30		AXMG15/RB/SF
	100 x 75	Rise and Fall	30		AXMG10/R&F/ASSY
	125 x 100	"	30		AXMG12/R&F/ASSY
	150 x 100	"	30		AXMG15/R&F/ASSY

Note: The products are available in a plain mill finish or with a BBA accredited polyester powder coated finish. Product codes in the tables refer to the mill finish. For polyester powder coated finish please add the suffix /PPC. Sundry items are not included as standard unless otherwise stated. Please order sundry items separately.

AX - Moulded Gutters and Fittings

90° Angle Assemblies

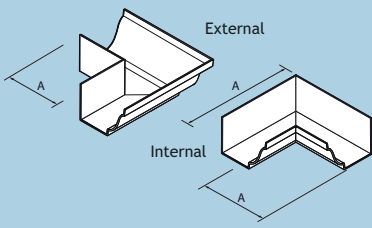
	Gutter Size	Type	A	Product Code
	100 x 75	External	100	AXMG10/EA90A
125 x 100	"	100	AXMG12/EA90A	
150 x 100	"	100	AXMG15/EA90A	
200 x 150	"	100	AXMG20/EA90A	
100 x 75	Internal	100	AXMG10/IA90A	
125 x 100	"	100	AXMG12/IA90A	
150 x 100	"	100	AXMG15/IA90A	
200 x 150	"	100	AXMG20/IA90A	

135° Angle Assemblies

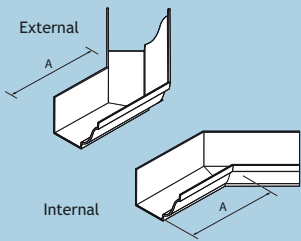
	Gutter Size	Type	A	Product Code
	100 x 75	External	100	AXMG10/EA135A
125 x 100	"	100	AXMG12/EA135A	
150 x 100	"	100	AXMG15/EA135A	
200 x 150	"	100	AXMG20/EA135A	
100 x 75	Internal	100	AXMG10/IA135A	
125 x 100	"	100	AXMG12/IA135A	
150 x 100	"	100	AXMG15/IA135A	
200 x 150	"	100	AXMG20/IA135A	

Note: Union Clip Assemblies include Union Clips and Slide Locks

Running Outlet Assemblies

	Gutter Size	Pipe Size	A	Product Code
	100 x 75	63 dia	300	AXMG10/RO25A
125 x 100	"	300	AXMG12/RO25A	
150 x 100	"	300	AXMG15/RO25A	
200 x 150	"	300	AXMG20/RO25A	
100 x 75	76 dia	300	AXMG10/RO30A	
125 x 100	"	300	AXMG12/RO30A	
150 x 100	"	300	AXMG15/RO30A	
200 x 150	"	300	AXMG20/RO30A	
125 x 100	102 dia	300	AXMG12/RO40A	
150 x 100	"	300	AXMG15/RO40A	
200 x 150	"	300	AXMG20/RO40A	
100 x 75	76 x 76	300	AXMG10/SO33A	
125 x 100	"	300	AXMG12/SO33A	
150 x 100	"	300	AXMG15/SO33A	
200 x 150	"	300	AXMG20/SO33A	
125 x 100	100 x 76	300	AXMG12/SO43A	
150 x 100	"	300	AXMG15/SO43A	
200 x 150	"	300	AXMG20/SO43A	
125 x 100	100 x 100	300	AXMG12/SO44A	
150 x 100	"	300	AXMG15/SO44A	
200 x 150	"	300	AXMG20/SO44A	

Note: A choice of three pipe systems is available. Product codes above denote that running outlets fit to Heritage socketed aluminium pipes.
ADD SUFFIX /F TO PRODUCT CODE TO FIT FLUSHJOINT OR GUARDIAN PIPES

Stop-End Assemblies

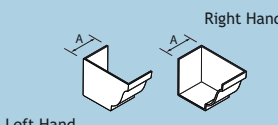
	Gutter Size	Type	A	Product Code
	100 x 75	Left Hand	50	AXMG10/SELHA
125 x 100	"	50	AXMG12/SELHA	
150 x 100	"	50	AXMG15/SELHA	
200 x 150	"	50	AXMG20/SELHA	
100 x 75	Right Hand	50	AXMG10/SERHA	
125 x 100	"	50	AXMG12/SERHA	
150 x 100	"	50	AXMG15/SERHA	
200 x 150	"	50	AXMG20/SERHA	

Note: The products are available in a plain mill finish or with a BBA accredited polyester powder coated finish. Product codes in the tables refer to the mill finish. For polyester powder coated finish please add the suffix /PPC. Sundry items are not included as standard unless otherwise stated. Please order sundry items separately.

GX - Pressed Aluminium Gutter Systems - Product Summary

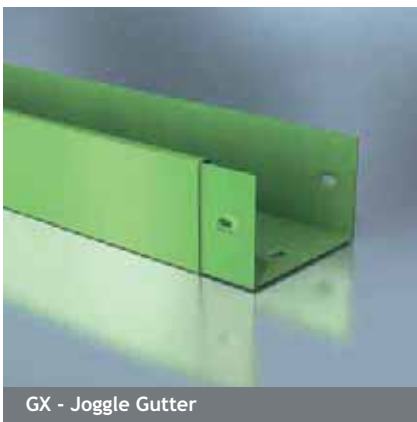

GX - Joggle Gutter



GX - Smooth Gutter



GX - Moulded Gutter

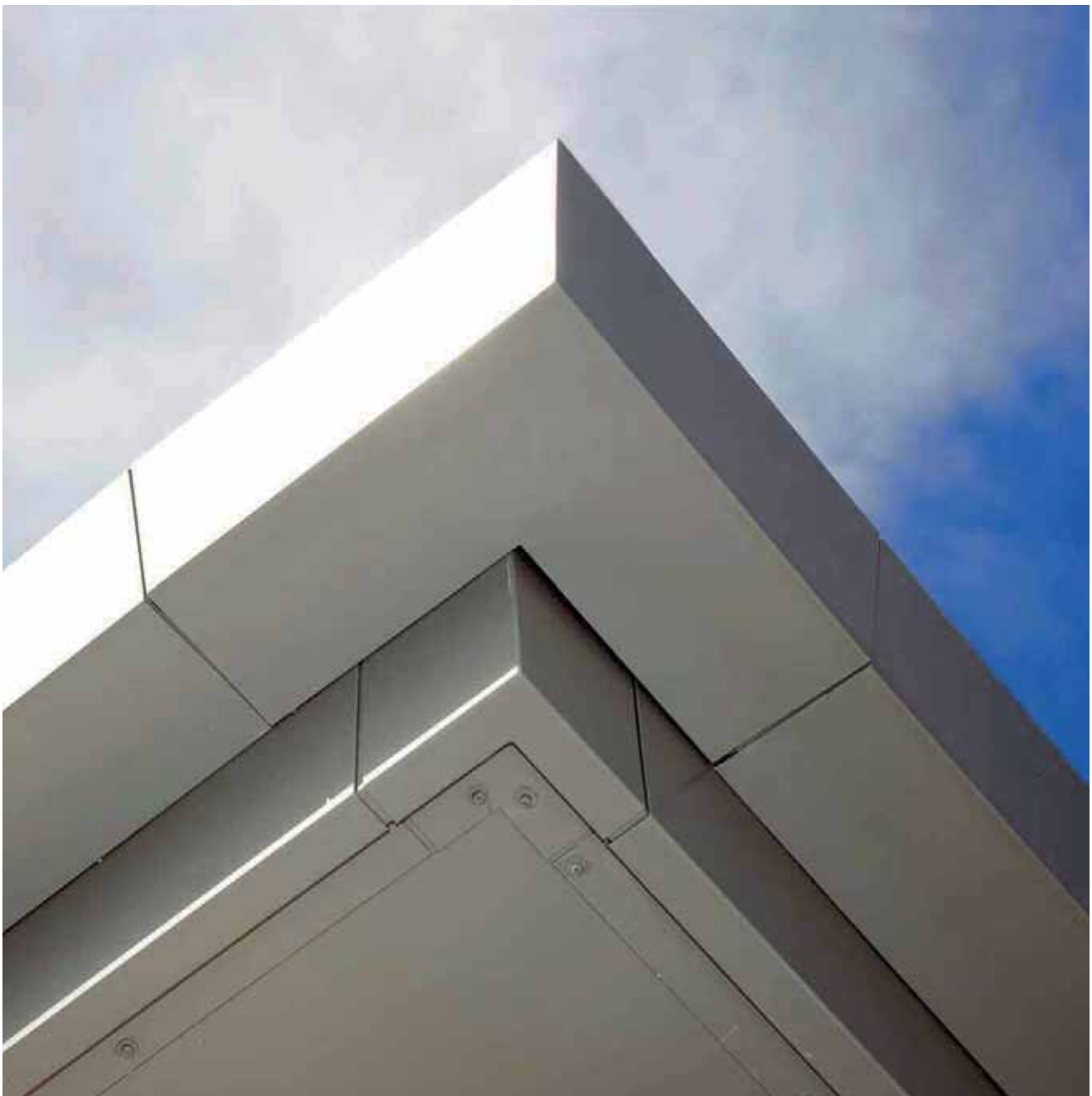

GX - Pressed Aluminium Gutter Systems - Product Summary

A robust and fully engineered box section gutter range designed for traditional wet jointing on site. GX is offered in three profiles in a choice of sizes and is especially suited to applications where maximum capacity gutters are required.

Applications

- High capacity gutters for traditional or modern buildings
- Fully compatible with Alumasc's Skyline fascia/soffit system
- Can provide an all aluminium eaves/soffit solution
- Gutters can be exposed or concealed

Features & Performance

- 3 gutter profiles available in 3 metre lengths, in a choice of sizes
- Designed to fully accommodate thermal movement at every joint
- Lightweight, durable and non-corrodible
- Life expectancy of aluminium: 40 years (rural/suburban areas); up to 25 years (industrial/marine areas)
- Easy to handle and fix
- BBA approved
- Aluminium is 100% recyclable

Colours & Finishes

- BBA approved polyester powder coatings, factory applied at Alumasc
- 26 standard colours with additional BS or RAL colours available to special order
- Also available in plain mill finish for on-site painting

Manufacture

- UK manufactured
- Gutter lengths, fittings and unions are pressed from various thicknesses of sheet aluminium (to BS EN 1462:1997, BS EN 612:1996 to BS EN 515:1993, BS EN 573:1995 and BS EN 485)

Installation & Fixing

- Wet sealed and bolted joints - a simple, well proven method
- Simple screw fixing with bracketry, generally concealed after fixing
- GX Joggle is supported by top straps
- GX Smooth is designed for simple jointing for a sleek appearance, including no requirement for sole support brackets and visible screw fixing
- GX Moulded is wet jointed and is fixed directly to the building fabric
- Minimal maintenance requirements

Gutter Profiles & Sizes

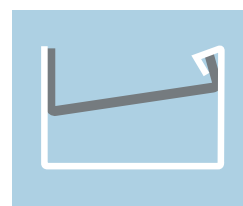

Joggle
100 x 75mm
125 x 100mm
150 x 100mm
150 x 150mm
200 x 150mm

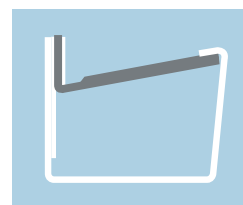

Smooth
120 x 75mm
140 x 100mm
170 x 125mm
175 x 150mm
225 x 150mm



Moulded
113 x 75mm
140 x 100mm
160 x 100mm
175 x 150mm
200 x 150mm



GX - Joggle Gutters and Fittings



GX Joggle Gutters are available in 5 sizes, together with a complete range of fittings. The range comprises vertical sides, sharp angled bends, and a returned lip, plus top strap for increased strength and rigidity. Factory finished in a choice of coloured BBA certificated powder coatings.

Notes: All dimensions are in mm unless shown otherwise.

Gutter sizes shown are nominal.

Gutter Lengths are left hand spigot. All fittings are double spigot.

Gutter Lengths

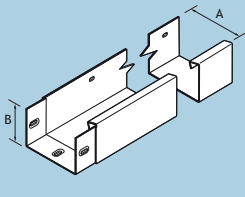

Gutter Size	Gutter Length	A	B	T	Product Code
100 x 75	3000mm	102	76	2	GXJ1/3MA
125 x 100	"	127	102	2	GXJ2/3MA
150 x 100	"	152	102	2	GXJ3/3MA
150 x 150	"	152	152	2	GXJ4/3MA
200 x 150	"	204	152	2	GXJ5/3MA

Note: T = gutter thickness (nominal). Gutter lengths are supplied complete with top strap and fixings

Top Straps



Gutter Size	A	Product Code
100 x 75	25	GXJ1/TS
125 x 100	25	GXJ2/TS
150 x 100	25	GXJ3/TS
150 x 150	25	GXJ4/TS
200 x 150	25	GXJ5/TS

Note: Gutters and fittings are supplied with top straps included. The codes in this table are for additional items, ordered as extras

Union Clips

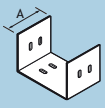

Gutter Size	A	Product Code
100 x 75	76	GXJ1/UCA
125 x 100	76	GXJ2/UCA
150 x 100	76	GXJ3/UCA
150 x 150	76	GXJ4/UCA
200 x 150	76	GXJ5/UCA

Stop-Ends - Internal

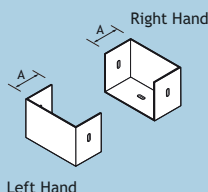

Gutter Size	Type	A	Product Code
100 x 75	Left Hand	40	GXJ1/SELHA
125 x 100	"	40	GXJ2/SELHA
150 x 100	"	40	GXJ3/SELHA
150 x 150	"	40	GXJ4/SELHA
200 x 150	"	40	GXJ5/SELHA
100 x 75	Right Hand	40	GXJ1/SERHA
125 x 100	"	40	GXJ2/SERHA
150 x 100	"	40	GXJ3/SERHA
150 x 150	"	40	GXJ4/SERHA
200 x 150	"	40	GXJ5/SERHA

Note: Stop-Ends are supplied complete with fixings

Note: The products are available in a plain mill finish or with a BBA accredited polyester powder coated finish. Product codes in the tables refer to the mill finish. For polyester powder coated finish please add the suffix /PPC. Sundry items are not included as standard unless otherwise stated. Please order sundry items separately. These notes also apply to pages 69, 70 and 71.

GX - Joggle Gutters and Fittings

90° Angles

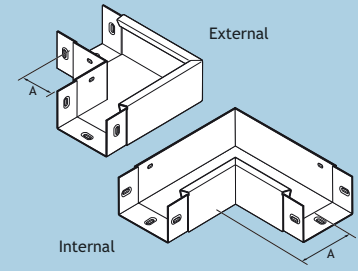
	Gutter Size	Type	A	Product Code
	Note: Angles are supplied complete with top strap and fixings	100 x 75	External	100
125 x 100		"	100	GXJ2/EA90A
150 x 100		"	100	GXJ3/EA90A
150 x 150		"	100	GXJ4/EA90A
200 x 150		"	100	GXJ5/EA90A
100 x 75		Internal	100	GXJ1/IA90A
125 x 100		"	100	GXJ2/IA90A
150 x 100		"	100	GXJ3/IA90A
150 x 150		"	100	GXJ4/IA90A
200 x 150		"	100	GXJ5/IA90A

135° Angles

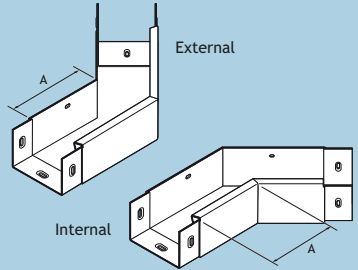
	Gutter Size	Type	A	Product Code
	Note: Angles are supplied complete with top strap and fixings	100 x 75	External	100
125 x 100		"	100	GXJ2/EA135A
150 x 100		"	100	GXJ3/EA135A
150 x 150		"	100	GXJ4/EA135A
200 x 150		"	100	GXJ5/EA135A
100 x 75		Internal	100	GXJ1/IA135A
125 x 100		"	100	GXJ2/IA135A
150 x 100		"	100	GXJ3/IA135A
150 x 150		"	100	GXJ4/IA135A
200 x 150		"	100	GXJ5/IA135A

Running Outlets - Standard

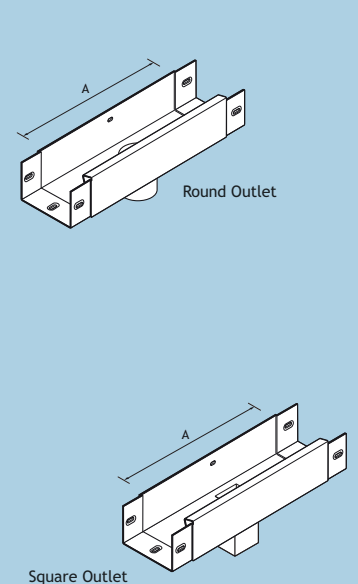
	Gutter Size	Pipe Size	A	Product Code
	Note: A choice of three pipe systems is available. Product codes denote that running outlets fit to Heritage socketed aluminium pipes. ADD SUFFIX /F TO PRODUCT CODE TO FIT FLUSHJOINT OR GUARDIAN PIPES Running Outlets are supplied complete with top strap and fixings	100 x 75	63 dia	300
125 x 100		"	300	GXJ2/RO25A
150 x 100		"	300	GXJ3/RO25A
150 x 150		"	300	GXJ4/RO25A
200 x 150		"	300	GXJ5/RO25A
100 x 75		75m dia	300	GXJ1/RO30A
125 x 100		"	300	GXJ2/RO30A
150 x 100		"	300	GXJ3/RO30A
150 x 150		"	300	GXJ4/RO30A
200 x 150		"	300	GXJ5/RO30A
125 x 100		100 dia	300	GXJ2/RO40A
150 x 100		"	300	GXJ3/RO40A
150 x 150		"	300	GXJ4/RO40A
200 x 150		"	300	GXJ5/RO40A
100 x 75		75 x 75	300	GXJ1/SO33A
125 x 100		"	300	GXJ2/SO33A
150 x 100		"	300	GXJ3/SO33A
150 x 150		"	300	GXJ4/SO33A
200 x 150		"	300	GXJ5/SO33A
100 x 75		100 x 75	300	GXJ1/SO43A
125 x 100		"	300	GXJ2/SO43A
150 x 100		"	300	GXJ3/SO43A
150 x 150		"	300	GXJ4/SO43A
200 x 150		"	300	GXJ5/SO43A
125 x 100	100 x 100	300	GXJ2/SO44A	
150 x 100	"	300	GXJ3/SO44A	
150 x 150	"	300	GXJ4/SO44A	
200 x 150	"	300	GXJ5/SO44A	

GX - Smooth Gutters and Fittings



GX Smooth Gutters are available in 5 sizes, together with a complete range of fittings. The range comprises soft corner radii and an inclined front wall terminating to a radiused lip, and is directly fixing to the building fabric. Factory finished in a choice of coloured BBA certificated powder coatings.

Notes: All dimensions are in mm unless shown otherwise.
Gutter sizes shown are nominal.

Gutter Lengths

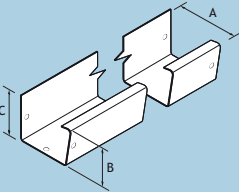
	Gutter Size	Gutter Length	A	B	C	T	Product Code
	120 x 75	3000mm	121	75	95	1.5	GXS1/3MA
140 x 100	"	140	98	119	1.5	GXS2/3MA	
170 x 125	"	170	125	145	1.5	GXS3/3MA	
175 x 150	"	176	150	170	1.5	GXS4/3MA	
225 x 150	"	224	150	170	1.5	GXS5/3MA	

Note: T = gutter thickness (nominal). Gutter lengths are supplied complete with union clip, bracket strap and fixings

Union Clips

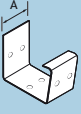
	Gutter Size	A	Product Code
	120 x 75	76	GXS1/UCA
140 x 100	76	GXS2/UCA	
170 x 125	76	GXS3/UCA	
175 x 150	76	GXS4/UCA	
225 x 150	76	GXS5/UCA	

Note: Gutters & fittings are supplied with union clips included. The codes in this table are for additional items, ordered as extras

Bracket/Straps

	Gutter Size	A	Product Code
	120 x 75	110	GXS1/BRKA
140 x 100	110	GXS2/BRKA	
170 x 125	110	GXS3/BRKA	
175 x 150	110	GXS4/BRKA	
225 x 150	110	GXS5/BRKA	

Note: Gutters & fittings are supplied with bracket straps included. The codes in this table are for additional items, ordered as extras

Stop-Ends - Internal

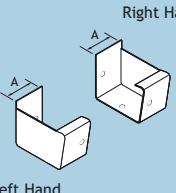
	Gutter Size	Type	A	Product Code
	120 x 75	Left Hand	40	GXS1/SELA
140 x 100	"	40	GXS2/SELA	
170 x 125	"	40	GXS3/SELA	
175 x 150	"	40	GXS4/SELA	
225 x 150	"	40	GXS5/SELA	
120 x 75	Right Hand	40	GXS1/SERA	
140 x 100	"	40	GXS2/SERA	
170 x 125	"	40	GXS3/SERA	
175 x 150	"	40	GXS4/SERA	
225 x 150	"	40	GXS5/SERA	

Note: Stop-Ends are supplied complete with union clip and fixings

GX - Smooth Gutters and Fittings

90° Angles

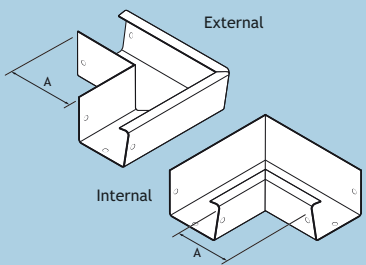
	Gutter Size	Type	A	Product Code
	<p>Note: Angles are supplied complete with union clip, bracket strap and fixings</p>	120 x 75	External	250
140 x 100		"	250	GXS2/EA90A
170 x 125		"	250	GXS3/EA90A
175 x 150		"	250	GXS4/EA90A
225 x 150		"	250	GXS5/EA90A
120 x 75		Internal	250	GXS1/IA90A
140 x 100		"	250	GXS2/IA90A
170 x 125		"	250	GXS3/IA90A
175 x 150		"	250	GXS4/IA90A
225 x 150		"	250	GXS5/IA90A

135° Angles

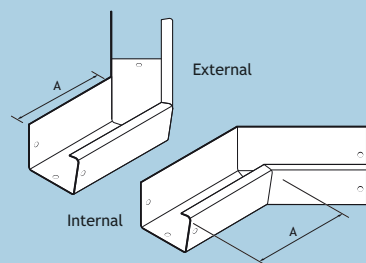
	Gutter Size	Type	A	Product Code
	<p>Note: Angles are supplied complete with union clip, bracket strap and fixings</p>	120 x 75	External	250
140 x 100		"	250	GXS2/EA135A
170 x 125		"	250	GXS3/EA135A
175 x 150		"	250	GXS4/EA135A
225 x 150		"	250	GXS5/EA135A
120 x 75		Internal	250	GXS1/IA135A
140 x 100		"	250	GXS2/IA135A
170 x 125		"	250	GXS3/IA135A
175 x 150		"	250	GXS4/IA135A
225 x 150		"	250	GXS5/IA135A

Running Outlets - Standard

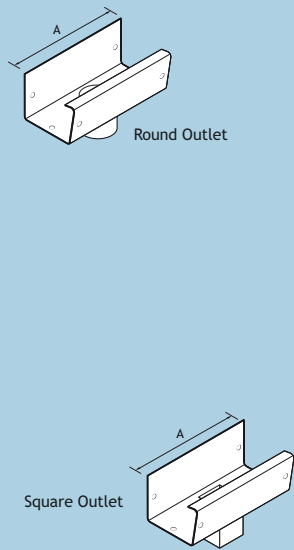
	Gutter Size	Pipe Size	A	Product Code
	<p>Note: A choice of three pipe systems is available. Product codes denote that running outlets fit to Heritage socketed aluminium pipes. ADD SUFFIX /F TO PRODUCT CODE TO FIT FLUSHJOINT OR GUARDIAN PIPES Running Outlets are supplied complete with union clip, bracket strap and fixings</p>	120 x 75	63 dia	500
140 x 100		"	500	GXS2/RO25A
170 x 125		"	500	GXS3/RO25A
175 x 150		"	500	GXS4/RO25A
225 x 150		"	500	GXS5/RO25A
120 x 75		75 dia	500	GXS1/RO30A
140 x 100		"	500	GXS2/RO30A
170 x 125		"	500	GXS3/RO30A
175 x 150		"	500	GXS4/RO30A
225 x 150		"	500	GXS5/RO30A
140 x 100		100 dia	500	GXS2/RO40A
170 x 125		"	500	GXS3/RO40A
175 x 150		"	500	GXS4/RO40A
225 x 150		"	500	GXS5/RO40A
120 x 75		75 X 75	500	GXS1/SO33A
140 x 100		"	500	GXS2/SO33A
170 x 125		"	500	GXS3/SO33A
175 x 150		"	500	GXS4/SO33A
225 x 150		"	500	GXS5/SO33A
140 x 100		100 x 75	500	GXS2/SO44A
170 x 125		"	500	GXS3/SO44A
175 x 150		"	500	GXS4/SO44A
225 x 150		"	500	GXS5/SO44A

GX - Moulded Gutters and Fittings



GX Moulded Gutters are available in 5 sizes, together with a complete range of fittings. In larger sizes the front wall is restrained by a top strap. The range is direct fixed to the building fabric. Factory finished in a choice of coloured BBA certificated powder coatings.

Notes: The GX Moulded range does not require brackets as it is direct fixed through the vertical back at pre-drilled, 600mm centre fixing holes. All dimensions are in mm unless shown otherwise. Gutter sizes shown are nominal.

Gutter Lengths

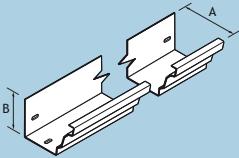
	Gutter Size	Gutter Length	A	B	T	Product Code
	113 x 75	3000m	113	76	2	GXM1/3MA
140 x 100	"	139	102	2	GXM2/3MA	
160 x 100	"	162	102	2	GXM3/3MA	
175 x 150	"	175	152	3	GXM4/3MA	
200 x 150	"	207	152	3	GXM5/3MA	

Note: T = gutter thickness (nominal)
Gutter lengths are supplied complete with union clip and fixings

Union Clips

	Gutter Size	A	Product Code
	113 x 75	76	GXM1/UCA
140 x 100	76	GXM2/UCA	
160 x 100	76	GXM3/UCA	
175 x 150	76	GXM4/UCA	
200 x 150	76	GXM5/UCA	

Note: Gutters and fittings are supplied with union clips included.
The codes in this table are for additional items, ordered as extras

Stop-Ends - Internal

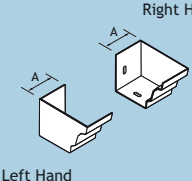
	Gutter Size	Type	A	Product Code
	Left Hand	113 x 75	Left Hand	40
140 x 100		"	40	GXM2/SELA
160 x 100		"	40	GXM3/SELA
175 x 150		"	40	GXM4/SELA
200 x 150		"	40	GXM5/SELA
Right Hand	113 x 75	Right Hand	40	GXM1/SERA
	140 x 100	"	40	GXM2/SERA
	160 x 100	"	40	GXM3/SERA
	175 x 150	"	40	GXM4/SERA
	200 x 150	"	40	GXM5/SERA

Note: Stop-Ends are supplied complete with fixings

Note: The products are available in a plain mill finish or with a BBA accredited polyester powder coated finish. Product codes in the tables refer to the mill finish. For polyester powder coated finish please add the suffix /PPC. Sundry items are not included as standard unless otherwise stated. Please order sundry items separately. These notes also apply to page 73.

GX - Moulded Gutters and Fittings

90° Angles

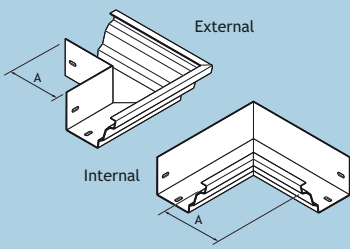
	Gutter Size	Type	A	Product Code
	<p>Note: Angles are supplied complete with union clip and fixings</p>	113 x 75	External	150
140 x 100		"	150	GXM2/EA90A
160 x 100		"	150	GXM3/EA90A
175 x 150		"	150	GXM4/EA90A
200 x 150		"	150	GXM5/EA90A
113 x 75		Internal	150	GXM1/IA90A
140 x 100		"	150	GXM2/IA90A
160 x 100		"	150	GXM3/IA90A
175 x 150		"	150	GXM4/IA90A
200 x 150		"	150	GXM5/IA90A

135° Angles

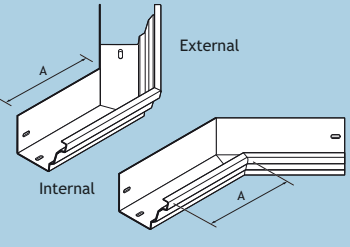
	Gutter Size	Type	A	Product Code
	<p>Note: Angles are supplied complete with union clip and fixings</p>	113 x 75	External	150
140 x 100		"	150	GXM2/EA135A
160 x 100		"	150	GXM3/EA135A
175 x 150		"	150	GXMS4/EA135A
200 x 150		"	150	GXM5/EA135A
113 x 75		Internal	150	GXM1/IA135A
140 x 100		"	150	GXM2/IA135A
160 x 100		"	150	GXM3/IA135A
175 x 150		"	150	GXM4/IA135A
200 x 150		"	150	GXM5/IA135A

Running Outlets - Standard

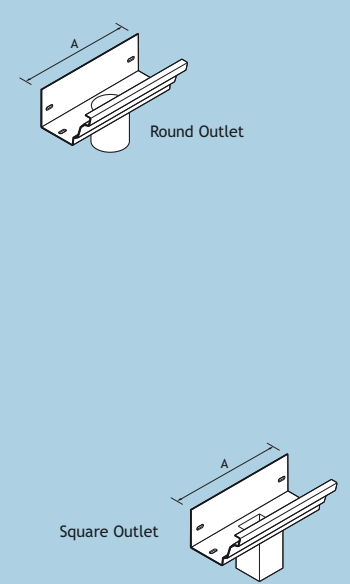
	Gutter Size	Pipe Size	A	Product Code
	<p>Note: A choice of three pipe systems is available. Product codes denote that running outlets fit to Heritage socketed aluminium pipes. ADD SUFFIX /F TO PRODUCT CODE TO FIT FLUSHJOINT OR GUARDIAN PIPES Running Outlets are supplied complete with union clip and fixings</p>	113 x 75	63 dia	300
140 x 100		"	300	GXM2/RO25A
160 x 100		"	300	GXM3/RO25A
175 x 150		"	300	GXM4/RO25A
200 x 150		"	300	GXM5/RO25A
113 x 75		75 dia	300	GXM1/RO30A
140 x 100		"	300	GXM2/RO30A
160 x 100		"	300	GXM3/RO30A
175 x 150		"	300	GXM4/RO30A
200 x 150		"	300	GXM5/RO30A
140 x 100		100 dia	300	GXM2/RO40A
160 x 100		"	300	GXM3/RO40A
175 x 150		"	300	GXM4/RO40A
200 x 150		"	300	GXM5/RO40A
113 x 75		75 x 75	300	GXM1/SO33A
140 x 100		"	300	GXM2/SO33A
160 x 100		"	300	GXM3/SO33A
175 x 150		"	300	GXM4/SO33A
200 x 150		"	300	GXM5/SO33A
113 x 75		100 x 75	300	GXM1/SO43A
140 x 100	"	300	GXM2/SO43A	
160 x 100	"	300	GXM3/SO43A	
175 x 150	"	300	GXM4/SO43A	
200 x 150	"	300	GXM5/SO43A	
140 x 100	100 x 100	300	GXM2/SO44A	
160 x 100	"	300	GXM3/SO44A	
175 x 150	"	300	GXM4/SO44A	
200 x 150	"	300	GXM5/SO44A	

Flushjoint - Aluminium Downpipe System - Product Summary



Flushjoint - Circular Pipe

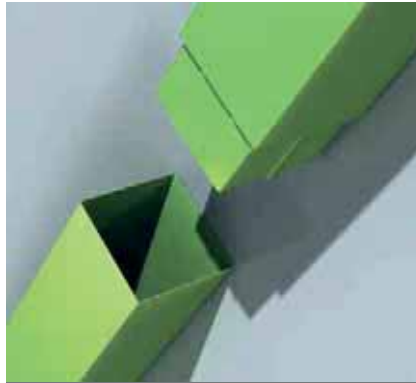

Flushjoint - Square Pipe



Flushjoint - Rectangular Pipe



Flushjoint - Aluminium Downpipe System - Product Summary

A contemporary range of extruded aluminium downpipes. The Flushjoint system is based on concealed spigots which give a smooth, clean appearance that complements modern building design. The pipes are mounted on brackets to stand clear of the structure.

Applications

- Contemporary pipework system suitable for new build and refurbishment projects
- Compatible with Heritage, Aqualine and GX gutter systems
- Flushjoint is not designed for use in underground drainage or as part of a soil or waste system

Features & Performance

- Choice of circular, square and rectangular pipes
- Hidden spigot jointing arrangement used to achieve completely smooth external appearance
- Material hardness and fixing mechanisms give excellent rigidity and high impact resistance
- Lightweight, durable and non-corrodible
- Life expectancy of aluminium: 40 years (rural/suburban areas); up to 25 years (industrial/marine areas)
- Easy to handle and fix
- Aluminium is 100% recyclable

Colours & Finishes

- BBA approved polyester powder coatings, factory applied at Alumasc
- 26 standard colours with additional BS or RAL colours available to special order
- Also available in plain mill finish for on-site painting

Manufacture

- UK manufactured
- Made from extruded aluminium to BS EN 12020:2001, BS EN 515:1993, BS EN 573:1995 and BS EN 755, from grade 6063 T6 alloy

Installation & Fixing

- Flushjoint pipework is built from the gutter downwards starting with the offsets and bends
- A choice of brackets are available to give varying projections
- Brackets secure pipework with minimum visual intrusion
- Minimal maintenance requirements



Pipe Profiles & Sizes

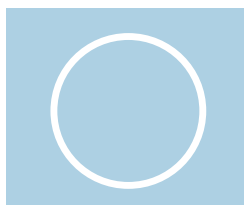

Circular Pipe
63mm dia
75mm dia
100mm dia
150mm dia



Square Pipe
75 x 75 mm
100 x 100 mm

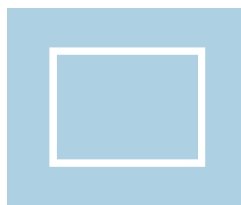

Rectangular Pipe
100 x 75 mm

Flushjoint - Circular Pipes and Fittings

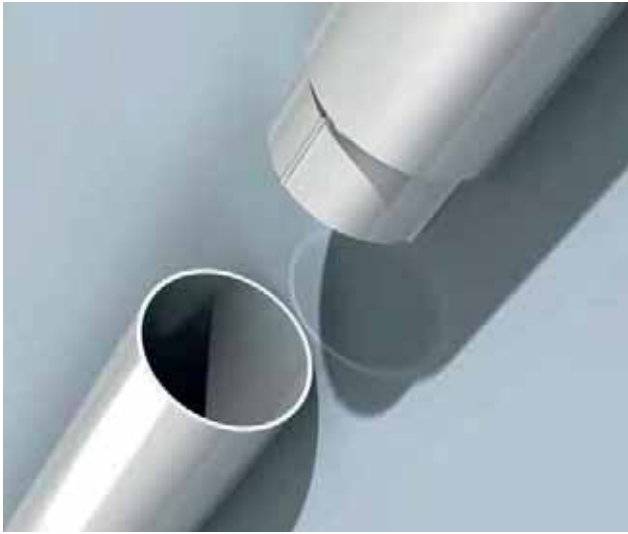

Flushjoint Circular Pipes are available in 4 sizes and 2 pipe lengths, together with a complete range of fittings. Flush spigot pipe connection for virtually undetectable joints. Factory finished in a choice of coloured BBA certificated powder coatings.

Notes: Flushjoint can be used with any Alumasc Gutter System, providing the girth of the gutter is sufficient to accommodate the cross section area of the pipe. Running outlets are made to order according to choice of gutter and project requirements.

All dimensions are in mm unless shown otherwise.

Pipe sizes shown are nominal.

Pipes

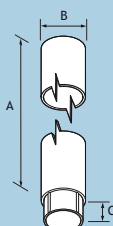
	Pipe Size	Pipe Length (A)	B	C	Product Code
	63 dia	3000mm	63	40	CP25/3MA
"	2000mm	63	40	CP25/2MA	
"	1000mm	63	40	CP25/1MA	
75 dia	3000mm	76.5	40	CP30/3MA	
"	2000mm	76.5	40	CP30/2MA	
"	1000mm	76.5	40	CP30/1MA	
100 dia	3000mm	102	40	CP40/3MA	
"	2000mm	102	40	CP40/2MA	
"	1000mm	102	40	CP40/1MA	
150 dia	3000mm	152	40	CP60/3MA	
"	2000mm	152	40	CP60/2MA	
"	1000mm	152	40	CP60/1MA	

Access Pipes

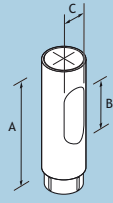
	Pipe Size	A	B	C	Product Code
	63 dia	300	150	50	CP25/ACPA
75 dia	300	150	60	CP30/ACPA	
100 dia	300	150	70	CP40/ACPA	
150 dia	400	200	100	CP60/ACPA	

Shoes

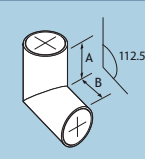
	Pipe Size	A	B	Product Code
	63 dia	100	25	CP25/SHA
75 dia	100	25	CP30/SHA	
100 dia	100	25	CP40/SHA	
150 dia	125	30	CP60/SHA	

Note: The products are available in a plain mill finish or with a BBA accredited polyester powder coated finish. Product codes in the tables refer to the mill finish. For polyester powder coated finish please add the suffix /PPC. Sundry items are not included as standard unless otherwise stated. Please order sundry items separately.

Flushjoint - Circular Pipes and Fittings

Bends

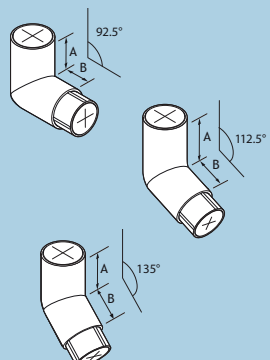

Pipe Size	Type	A	B	Product Code
63 dia	92.5 Degree	100	100	CP25/B/92A
75 dia	"	100	100	CP30/B/92A
100 dia	"	100	100	CP40/B/92A
150 dia	"	100	100	CP60/B/92A
63 dia	112.5 Degree	100	100	CP25/B/112A
75 dia	"	100	100	CP30/B/112A
100 dia	"	100	100	CP40/B/112A
150 dia	"	100	100	CP60/B/112A
63 dia	135 Degree	100	100	CP25/B/135A
75 dia	"	100	100	CP30/B/135A
100 dia	"	100	100	CP40/B/135A
150 dia	"	100	100	CP60/B/135A

Branches

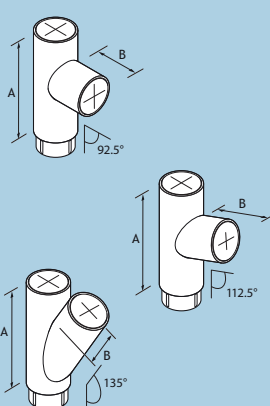

Pipe Size	Type	A	B	Product Code
63 dia	92.5 Degree	300	100	CP25/BR/92A
75 dia	"	300	100	CP30/BR/92A
100 dia	"	300	100	CP40/BR/92A
150 dia	"	400	150	CP60/BR/92A
63 dia	112.5 Degree	300	100	CP25/BR/112A
75 dia	"	300	100	CP30/BR/112A
100 dia	"	300	100	CP40/BR/112A
150 dia	"	400	150	CP60/BR/112A
63 dia	135 Degree	300	100	CP25/BR/135A
75 dia	"	300	100	CP30/BR/135A
100 dia	"	300	100	CP40/BR/135A
150 dia	"	400	150	CP60/BR/135A

92.5° Two Part Offsets



Pipe Size	Offset	A	B	Product Code
63 dia	250	100	250	CP25/250/92A
"	500	100	500	CP25/500/92A
"	750	100	750	CP25/750/92A
"	1000	100	1000	CP25/1000/92A
75 dia	250	100	250	CP30/250/92A
"	500	100	500	CP30/500/92A
"	750	100	750	CP30/750/92A
"	1000	100	1000	CP30/1000/92A
100 dia	250	100	250	CP40/250/92A
"	500	100	500	CP40/500/92A
"	750	100	750	CP40/750/92A
"	1000	100	1000	CP40/1000/92A
150 dia	250	100	250	CP60/250/92A
"	500	100	500	CP60/500/92A
"	750	100	750	CP60/750/92A
"	1000	100	1000	CP60/1000/92A

Note: The products are available in a plain mill finish or with a BBA accredited polyester powder coated finish. Product codes in the tables refer to the mill finish. For polyester powder coated finish please add the suffix /PPC. Sundry items are not included as standard unless otherwise stated. Please order sundry items separately.

Flushjoint - Circular Pipes and Fittings

112.5° Two Part Offsets



Pipe Size	Offset	A	B	Product Code
63 dia	250	100	250	CP25/250/112A
"	500	100	500	CP25/500/112A
"	750	100	750	CP25/750/112A
"	1000	100	1000	CP25/1000/112A
75 dia	250	100	250	CP30/250/112A
"	500	100	500	CP30/500/112A
"	750	100	750	CP30/750/112A
"	1000	100	1000	CP30/1000/112A
100 dia	250	100	250	CP40/250/112A
"	500	100	500	CP40/500/112A
"	750	100	750	CP40/750/112A
"	1000	100	1000	CP40/1000/112A
150 dia	250	100	250	CP60/250/112A
"	500	100	500	CP60/500/112A
"	750	100	750	CP60/750/112A
"	1000	100	1000	CP60/1000/112A

135° Two Part Offsets



Pipe Size	Offset	A	B	Product Code
63 dia	250	100	250	CP25/250/135A
"	500	100	500	CP25/500/135A
"	750	100	750	CP25/750/135A
"	1000	100	1000	CP25/1000/135A
75 dia	250	100	250	CP30/250/135A
"	500	100	500	CP30/500/135A
"	750	100	750	CP30/750/135A
"	1000	100	1000	CP30/1000/135A
100 dia	250	100	250	CP40/250/135A
"	500	100	500	CP40/500/135A
"	750	100	750	CP40/750/135A
"	1000	100	1000	CP40/1000/135A
150 dia	250	100	250	CP60/250/135A
"	500	100	500	CP60/500/135A
"	750	100	750	CP60/750/135A
"	1000	100	1000	CP60/1000/135A

135° Fixed Offsets

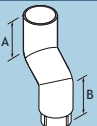

Pipe Size	Offset	A	B	Product Code
63 dia	75	100	100	CP25/75/135A
75 dia	75	100	100	CP30/75/135A
100 dia	75	100	100	CP40/75/135A

Loose Spigots



Pipe Size	A	Product Code
63 dia	100	RW1/SPIG/100
75 dia	100	RW2/SPIG/100
100 dia	100	RW3/SPIG/100

Note: The products are available in a plain mill finish or with a BBA accredited polyester powder coated finish. Product codes in the tables refer to the mill finish. For polyester powder coated finish please add the suffix /PPC. Sundry items are not included as standard unless otherwise stated. Please order sundry items separately.

Flushjoint - Circular Pipes and Fittings

Standard Base Clips

Diagram	Pipe Size	A	B	C	D	Product Code
<p>63 dia, 75 dia 100 dia 150 dia</p>	63 dia	124	100	65	33.5	RW1/236
	75 dia	137	112	71	33	RW2/237
	100 dia	163	138	90	39	RW3/238
	150 dia	255	215	121		RW60/PC

Extended Base Clips

Diagram	Pipe Size	A	B	C	Product Code
	63 dia	87	47	279	RW1/364
	75 dia	87	47	285	RW2/365
	100 dia	87	47	304	RW3/366

Small Base Clips

Diagram	Pipe Size	A	B	C	Product Code
	63 dia	87	47	74	RW1/SB/PC
	75 dia	87	47	80	RW2/SB/PC
	100 dia	87	47	92	RW3/SB/PC

Contemporary Rainwater Heads

Diagram	Pipe Size	A	B	C	Product Code
	63 dia	250	180	200	CP25/HOP
	75 dia	250	180	200	CP30/HOP
	100 dia	250	180	200	CP40/HOP

Note: Traditional design hopper heads can also be used if desired.
 The spigot position is suited to a standard pipe clip. If a small base pipe clip is required please state this at point of ordering, so that the hopper can be fabricated to suit.
 Please refer to sections of this brochure covering Heritage Pipes and Fittings.



Note: The products are available in a plain mill finish or with a BBA accredited polyester powder coated finish. Product codes in the tables refer to the mill finish. For polyester powder coated finish please add the suffix /PPC. Sundry items are not included as standard unless otherwise stated. Please order sundry items separately.

Flushjoint - Square and Rectangular Pipes and Fittings

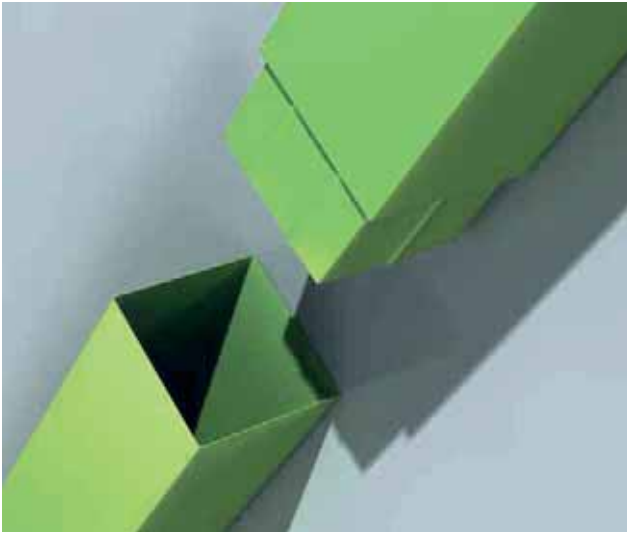

Flushjoint Square and Rectangular Pipes are available in 3 sizes and 2 pipe lengths, together with a complete range of fittings. Flush spigot pipe connection for virtually undetectable joints. Factory finished in a choice of coloured BBA certificated powder coatings.

Notes: Flushjoint can be used with any Alumasc Gutter System, providing the girth of the gutter is sufficient to accommodate the cross section area of the pipe. Running outlets are made to order according to choice of gutter and project requirements.

All dimensions are in mm unless shown otherwise.

Pipe sizes shown are nominal.

Pipes

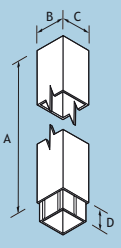
	Pipe Size	Pipe Length (A)	B	C	D	Product Code
	75 x 75	3000mm	72	72	40	CP33/3MA
	"	2000mm	72	72	40	CP33/2MA
	"	1000mm	72	72	40	CP33/1MA
	100 x 75	3000mm	102	76	40	CP43/3MA
	"	2000mm	102	76	40	CP43/2MA
	"	1000mm	102	76	40	CP43/1MA
	100 x 100	3000mm	102	102	40	CP44/3MA
	"	2000mm	102	102	40	CP44/2MA
	"	1000mm	102	102	40	CP44/1MA

Access Pipes

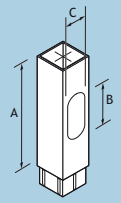
	Pipe Size	A	B	C	Product Code
	75 x 75	300	150	60	CP33/ACPA
	100 x 75	300	150	75	CP43/ACPA
	100 x 100	300	150	75	CP44/ACPA

Shoe

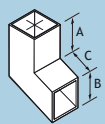
	Pipe Size	A	B	C	Product Code
	75 x 75	100	55	25	CP33/SHA
	100 x 75	100	70	25	CP43/SHA
	100 x 100	100	70	25	CP44/SHA

Note: The products are available in a plain mill finish or with a BBA accredited polyester powder coated finish. Product codes in the tables refer to the mill finish. For polyester powder coated finish please add the suffix /PPC. Sundry items are not included as standard unless otherwise stated. Please order sundry items separately.

Flushjoint - Square and Rectangular Pipes and Fittings

Bends

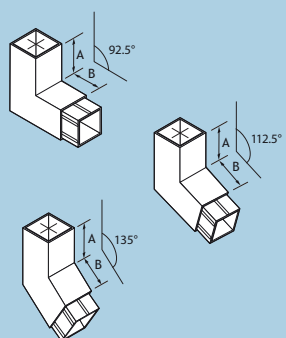

Pipe Size	Type	A	B	Product Code
75 x 75	92.5 Degree	100	100	CP33/B/92A
100 x 75	"	100	100	CP43/B/92A
100 x 100	"	100	100	CP44/B/92A
75 x 75	112.5 Degree	100	100	CP33/B/112A
100 x 75	"	100	100	CP43/B/112A
100 x 100	"	100	100	CP44/B/112A
75 x 75	135 Degree	100	100	CP33/B/135A
100 x 75	"	100	100	CP43/B/135A
100 X 100	"	100	100	CP44/B/135A

Branches

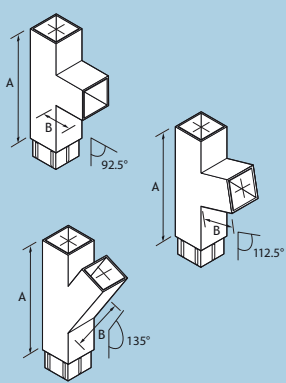

Pipe Size	Type	A	B	Product Code
75 x 75	92.5 Degree	300	100	CP33/BR/92A
100 x 75	"	300	100	CP43/BR/92A
100 x 100	"	300	100	CP44/BR/92A
75 x 75	112.5 Degree	300	100	CP33/BR/112A
100 x 75	"	300	100	CP43/BR/112A
100 x 100	"	300	100	CP44/BR/112A
75 x 75	135 Degree	300	100	CP33/BR/135A
100 x 75	"	300	100	CP43/BR/135A
100 x 100	"	300	100	CP44/BR/135A

92.5° Two Part Offsets

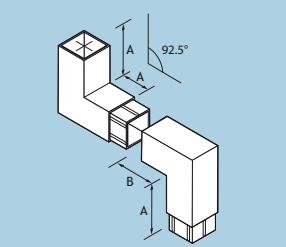

Pipe Size	Offset	A	B	Product Code
75 x 75	250	100	250	CP33/250/92A
"	500	100	500	CP33/500/92A
"	750	100	750	CP33/750/92A
"	1000	100	1000	CP33/1000/92A
100 x 75	250	100	250	CP43/250/92A
"	500	100	500	CP43/500/92A
"	750	100	750	CP43/750/92A
"	1000	100	1000	CP43/1000/92A
100 x 100	250	100	250	CP44/250/92A
"	500	100	500	CP44/500/92A
"	750	100	750	CP44/750/92A
"	1000	100	1000	CP44/1000/92A

Note: The products are available in a plain mill finish or with a BBA accredited polyester powder coated finish. Product codes in the tables refer to the mill finish. For polyester powder coated finish please add the suffix /PPC. Sundry items are not included as standard unless otherwise stated. Please order sundry items separately.

Flushjoint - Square and Rectangular Pipes and Fittings

112.5° Two Part Offsets

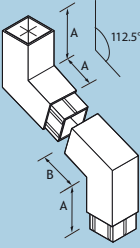

Pipe Size	Offset	A	B	Product Code
75 x 75	250	100	250	CP33/250/112A
"	500	100	500	CP33/500/112A
"	750	100	750	CP33/750/112A
"	1000	100	1000	CP33/1000/112A
100 x 75	250	100	250	CP43/250/112A
"	500	100	500	CP43/500/112A
"	750	100	750	CP43/750/112A
"	1000	100	1000	CP43/1000/112A
100 x 100	250	100	250	CP44/250/112A
"	500	100	500	CP44/500/112A
"	750	100	750	CP44/750/112A
"	1000	100	1000	CP44/1000/112A

135° Two Part Offsets

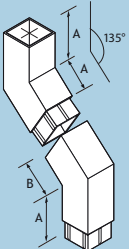

Pipe Size	Offset	A	B	Product Code
75 x 75	250	100	250	CP33/250/135A
"	500	100	500	CP33/500/135A
"	750	100	750	CP33/750/135A
"	1000	100	1000	CP33/1000/135A
100 x 75	250	100	250	CP43/250/135A
"	500	100	500	CP43/500/135A
"	750	100	750	CP43/750/135A
"	1000	100	1000	CP43/1000/135A
100 x 100	250	100	250	CP44/250/135A
"	500	100	500	CP44/500/135A
"	750	100	750	CP44/750/135A
"	1000	100	1000	CP44/1000/135A

135° Fixed Offsets

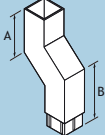

Pipe Size	Offset	A	B	Product Code
75 x 75	75	100	100	CP33/75/135A
100 x 75	75	100	100	CP43/75/135A
100 x 100	75	100	100	CP44/75/135A

Loose Spigots



Pipe Size	A	Product Code
75 x 75	100	RW33/SPIG/100
100 x 75	100	RW43/SPIG/100
100 x 100	100	RW44/SPIG/100

Note: The products are available in a plain mill finish or with a BBA accredited polyester powder coated finish. Product codes in the tables refer to the mill finish. For polyester powder coated finish please add the suffix /PPC. Sundry items are not included as standard unless otherwise stated. Please order sundry items separately.

Flushjoint - Square and Rectangular Pipes and Fittings

Standard Base Clips

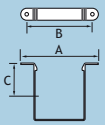
	Pipe Size	A	B	C	Product Code
	75 x 75	133	109	52	RW33/PC
	100 x 75	163	138	54	RW43/PC
	100 x 100	163	138	67	RW44/PC

Extended Base Clips

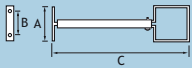
	Pipe Size	A	B	C	Product Code
	75 x 75	84	47	290 max	RW33/EX/PC
	100 x 75	84	47	292 max	RW43/EX/PC
	100 x 100	84	47	305 max	RW44/EX/PC

Small Base Clips

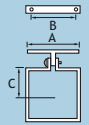
	Pipe Size	A	B	C	Product Code
	75 x 75	84	47	78	RW33/SB/PC
	100 x 75	84	47	80	RW43/SB/PC
	100 x 100	84	47	94	RW44/SB/PC

Contemporary Rainwater Heads

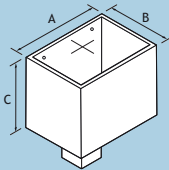
	Pipe Size	A	B	C	Product Code
	75 x 75	250	180	200	CP33/HOP
	100 x 75	250	180	200	CP43/HOP
	100 x 100	250	180	200	CP44/HOP

Note: Traditional design hopper heads can also be used if desired.
 The spigot position is suited to a standard pipe clip. If a small base pipe clip is required please state this at point of ordering, so that the hopper can be fabricated to suit.
 Please refer to sections of this brochure covering Heritage Pipes and Fittings.



Note: The products are available in a plain mill finish or with a BBA accredited polyester powder coated finish. Product codes in the tables refer to the mill finish. For polyester powder coated finish please add the suffix /PPC. Sundry items are not included as standard unless otherwise stated. Please order sundry items separately.

Swaged - Aluminium Downpipe System - Product Summary



Swaged - Circular Pipe



Swaged - Aluminium Downpipe System - Product Summary

An economical aluminium downpipe system with circular pipes available in a choice of three diameters.

Applications

- Contemporary pipework system suitable for both new build and refurbishment projects
- Compatible with the AX extruded aluminium gutter range
- Long-life alternative to uPVC gutters

Features & Performance

- Circular downpipe, in a choice of three sizes
- Expanded pipe end to create an integral connection
- Lightweight, durable and non-corrodible
- Material hardness and fixing mechanisms give excellent rigidity and high impact resistance
- Life expectancy of aluminium: 40 years (rural/suburban areas); up to 25 years (industrial/marine areas)
- Easy to handle and fix
- Aluminum is 100% recyclable

Colours & Finishes

- BBA approved polyester powder coatings, factory applied at Alumasc
- 26 standard colours with additional BS or RAL colours available to special order
- Also available in plain mill finish for on-site painting

Manufacture

- UK manufactured
- Made from extruded aluminium to BS EN 12020:2001, BS EN 515:1993, BS EN 573:1995 and BS EN 755, from grade 6063 T6 alloy.

Installation & Fixing

- Swaged pipework is built from the gutter downwards starting with the offset
- Standard pipe clips can be used to fix the pipework to the building façade
- Minimal maintenance requirements

Pipe Profile & Sizes

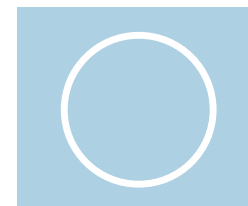

63mm dia
75mm dia
100mm dia



Swaged - Circular Pipes and Fittings



Swaged Circular Downpipes are available in a choice of three diameters and a complete range of fittings. The expanded pipe end creates an integral connection. Factory finished in a choice of BBA approved polyester powder coatings.

Notes: All dimensions are in mm unless shown otherwise.
Pipe sizes shown are nominal.

Pipes

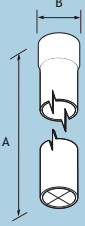
	Pipe Size	Pipe Length (A)	B	Product Code
	63 dia	3000mm	63	SW25/3M
	"	2000mm	63	SW25/2M
	"	1000mm	63	SW25/1M
	75 dia	3000mm	75	SW30/3M
	"	2000mm	75	SW30/2M
	"	1000mm	75	SW30/1M
	100 dia	3000mm	100	SW40/3M
	"	2000mm	100	SW40/2M
	"	1000mm	100	SW40/1M

Access Pipes

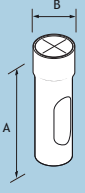
	Pipe Size	A	B	Product Code
	63 dia	300	63	SW25/ACP
	75 dia	300	75	SW30/ACP
	100 dia	300	100	SW40/ACP

Shoes

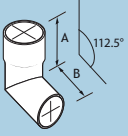
	Pipe Size	A	B	Product Code
	63 dia	100	25	SW25/SH
	75 dia	100	25	SW30/SH
	100 dia	100	25	SW40/SH

Note: The products are available in a plain mill finish or with a BBA accredited polyester powder coated finish. Product codes in the tables refer to the mill finish. For polyester powder coated finish please add the suffix /PPC. Sundry items are not included as standard unless otherwise stated. Please order sundry items separately.

Swaged - Circular Pipes and Fittings

Bends

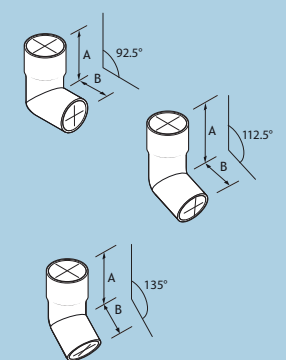

Pipe Size	Type	A	B	Product Code
63 dia	92.5 Degree	100	100	SW25/B/92
75 dia	"	100	100	SW30/B/92
100 dia	"	100	100	SW40/B/92
63 dia	112.5 Degree	100	100	SW25/B/112
75 dia	"	100	100	SW30/B/112
100 dia	"	100	100	SW40/B/112
63 dia	135 Degree	100	100	SW25/B/135
75 dia	"	100	100	SW30/B/135
100 dia	"	100	100	SW40/B/135

Branches

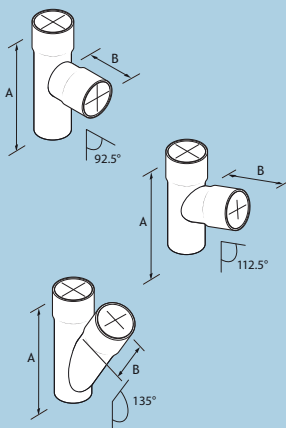

Pipe Size	Type	A	B	Product Code
63 dia	92.5 Degree	300	100	SW25/BR/92
75 dia	"	300	100	SW30/BR/92
100 dia	"	300	100	SW40/BR/92
63 dia	112.5 Degree	300	100	SW25/BR/112
75 dia	"	300	100	SW30/BR/112
100 dia	"	300	100	SW40/BR/112
63 dia	135 Degree	300	100	SW25/BR/135
75 dia	"	300	100	SW30/BR/135
100 dia	"	300	100	SW40/BR/135

Double Branches

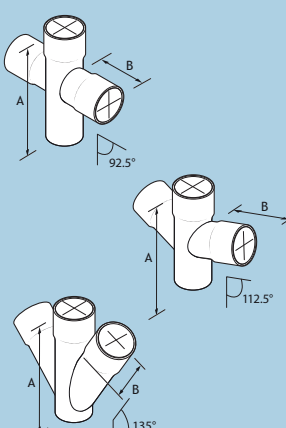

Pipe Size	Type	A	B	Product Code
63 dia	92.5 Degree	300	100	SW25/DBR/92
75 dia	"	300	100	SW30/DBR/92
100 dia	"	300	100	SW40/DBR/92
63 dia	112.5 Degree	300	100	SW25/DBR/112
75 dia	"	300	100	SW30/DBR/112
100 dia	"	300	100	SW40/DBR/112
63 dia	135 Degree	300	100	SW25/DBR/135
75 dia	"	300	100	SW30/DBR/135
100 dia	"	300	100	SW40/DBR/135

Note: The products are available in a plain mill finish or with a BBA accredited polyester powder coated finish. Product codes in the tables refer to the mill finish. For polyester powder coated finish please add the suffix /PPC. Sundry items are not included as standard unless otherwise stated. Please order sundry items separately.

Swaged - Circular Pipes and Fittings

112.5° Fixed Offsets

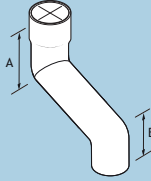
	Pipe Size	Offset	A	B	Product Code
	63 dia	75	100	100	SW25/FO/75
	75 dia	75	100	100	SW30/FO/75
	100 dia	75	100	100	SW40/FO/75

112.5° Two Part Offsets

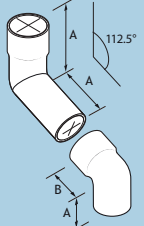
	Pipe Size	Offset	A	B	Product Code
	63 dia	250	xx	100	SW25/TPO/250
	"	500	xx	100	SW25/TPO/500
	"	750	xx	100	SW25/TPO/750
	"	1000	xx	100	SW25/TPO/1000
	75 dia	250	xx	100	SW30/TPO/250
	"	500	xx	100	SW30/TPO/500
	"	750	xx	100	SW30/TPO/750
	"	1000	xx	100	SW30/TPO/1000
	100 dia	250	xx	100	SW40/TPO/250
	"	500	xx	100	SW40/TPO/500
	"	750	xx	100	SW40/TPO/750
	"	1000	xx	100	SW40/TPO/1000

Note: The products are available in a plain mill finish or with a BBA accredited polyester powder coated finish. Product codes in the tables refer to the mill finish. For polyester powder coated finish please add the suffix /PPC. Sundry items are not included as standard unless otherwise stated. Please order sundry items separately.

Swaged - Circular Pipes and Fittings

Standard Base Clips

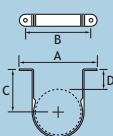
	Pipe Size	A	B	C	D	Product Code
	63 dia	124	100	65	33.5	RW1/236
75 dia	137	112	71	33	RW2/237	
100 dia	163	138	90	39	RW3/238	

Extended Base Clips

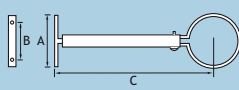
	Pipe Size	A	B	C	Product Code
	63 dia	87	47	279	RW1/364
75 dia	87	47	285	RW2/365	
100 dia	87	47	304	RW3/366	

Small Base Clips

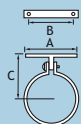
	Pipe Size	A	B	C	Product Code
	63 dia	87	47	74	RW1/SB/PC
75 dia	87	47	80	RW2/SB/PC	
100 dia	87	47	92	RW3/SB/PC	

Contemporary Rainwater Heads

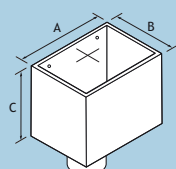
	Pipe Size	A	B	C	Product Code
	63 dia	250	180	200	CP25/HOP
75 dia	250	180	200	CP30/HOP	
100 dia	250	180	200	CP40/HOP	

Note: Traditional design hopper heads can also be used if desired.
 The spigot position is suited to a standard pipe clip. If a small base pipe clip is required please state this at point of ordering, so that the hopper can be fabricated to suit.
 Please refer to sections of this brochure covering Heritage Pipes and Fittings.

Note: The products are available in a plain mill finish or with a BBA accredited polyester powder coated finish. Product codes in the tables refer to the mill finish. For polyester powder coated finish please add the suffix /PPC. Sundry items are not included as standard unless otherwise stated. Please order sundry items separately.

Guardian - Aluminium Security Pipe System - Product Summary



Guardian - Circular Pipe



Guardian - Square Pipe

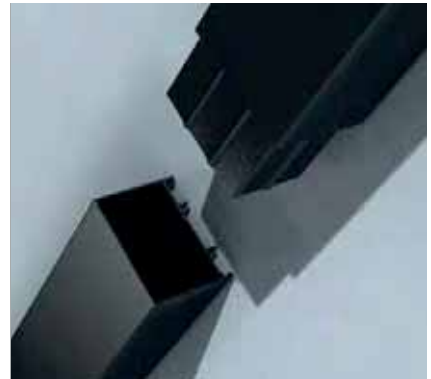

Guardian - Rectangular Pipe



Guardian - Aluminium Security Pipe System - Product Summary

A contemporary range of extruded aluminium downpipes designed for mounting flush with the building fabric. Guardian pipework has concealed brackets and concealed jointing which provides a high level of security.

Applications

- Specifically designed for security conscious environments
- Suitable for new build and refurbishment projects
- Compatible with Heritage, Aqualine and GX gutter systems

Features & Performance

- Choice of circular, square and rectangular pipes
- Profiles fit flush to the wall making them vandal resistant and ungrippable
- Lightweight, durable and non-corrodible

- Life expectancy of aluminium: 40 years (rural/suburban areas); up to 25 years (industrial/marine areas)
- Easy to handle and fix
- Aluminium is 100% recyclable

Colours & Finishes

- BBA approved polyester powder coatings, factory applied at Alumasc
- 26 standard colours with additional BS or RAL colours available to special order
- Also available in plain mill finish for on-site painting

Manufacture

- UK manufactured
- Made from extruded aluminium to BS EN 12020:2001, BS EN 515:1993, BS EN 573:1995 and BS EN 755, from grade 6063 T6 alloy

Installation & Fixing

- Method of fixing allows pipes to be fitted into a recess in the facade
- Systems are assembled from the ground upwards connecting to running outlets
- Special drain connectors are available for connection to gullies
- Minimal maintenance requirements



Pipe Profiles & Sizes



Circular Pipe
86 x 106mm
111 x 138mm



Square Pipe
80 x 72mm
109 x 102mm



Rectangular Pipe
84 x 102mm

Guardian - Circular Pipes and Fittings



Guardian Circular Pipes are available in 2 sizes and pipe lengths of 2m. Concealed flush fixing ensures that the pipe cannot be scaled. Factory finished in a choice of coloured BBA certificated powder coatings.

Notes: Guardian is a bespoke manufactured range. Contact Alumasc Technical Services for more information.

All dimensions are in mm unless shown otherwise.

Pipes

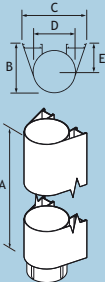
	Pipe Size	Pipe Length (A)	B	C	D	E	Product Code
	86 x 106	2000mm	86	106	70	47	HSP/V30/2MA
	"	1000mm	86	106	70	47	HSP/V30/1MA
	111 x 138	2000mm	111	138	102	60	HSP/V40/2MA
	"	1000mm	111	138	102	60	HSP/V40/1MA

Access Pipes

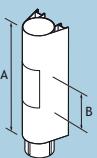
	Pipe Size	A	B	Product Code
	86 x 106	300	150	HSP/V30/ACP
	111 x 138	300	150	HSP/V40/ACP

Shoe

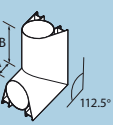
	Pipe Size	A	B	Product Code
	86 x 106	30	100	HSP/V30/SH
	111 x 138	30	100	HSP/V40/SH

Drain Connector

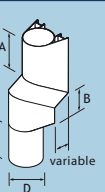
	Pipe Size	A	B	C	D	Product Code
	86 x 106	100	100	100	Variable	HSP/V30/ZADP
	111 x 138	100	100	100	Variable	HSP/V40/ZADP

Note: This is a made to order item. Dimensions are required from the wall to the centre of the drain prior to placing an order

Note: The products are available in a plain mill finish or with a BBA accredited polyester powder coated finish. Product codes in the tables refer to the mill finish. For polyester powder coated finish please add the suffix /PPC. Sundry items are not included as standard unless otherwise stated. Please order sundry items separately.

Guardian - Circular Pipes and Fittings

Bend

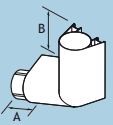
	Pipe Size	A	Product Code
	86 x 106	100	HSP/V30/ZBND
	111 x 138	100	HSP/V40/ZBND
Note: Please specify whether left, right, front or rear is required Please specify whether 92.5, 112.5 or 135° is required			

Branch

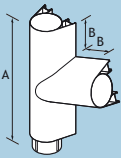
	Pipe Size	A	B	Product Code
	86 x 106	300	100	HSP/V30/ZBRN
	111 x 138	300	100	HSP/V40/ZBRN
Note: Please state whether left or right hand is required Please specify whether 92.5, 112.5 or 135° is required				

Offset

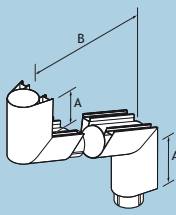
	Pipe Size	Offset	A	B	Product Code
	86 x 106	Up to 305	100	305	HSP/V30/305
	111 x 138	Up to 305	100	305	HSP/V40/305
	86 x 106	Up to 533	100	533	HSP/V30/533
	111 x 138	Up to 533	100	533	HSP/V40/533
	86 x 106	Up to 762	100	762	HSP/V30/762
	111 x 138	Up to 762	100	762	HSP/V40/762
Note: Please specify whether 92.5, 112.5 or 135° is required Front, left and right offsets also available					

135° Fixed Offsets

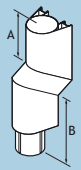
	Pipe Size	Offset	A	B	Product Code
	86 x 106	75	100	100	HSP/V30/75/135A
	111 x 138	75	100	100	HSP/V40/75/135A

Make-Up Piece

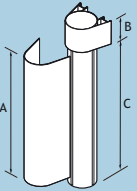
	Pipe Size	A	B	C	Product Code
	86 x 106	340	60	380	HSP/V30/MUP
	111 x 138	340	60	380	HSP/V40/MUP

Contemporary Rainwater Heads

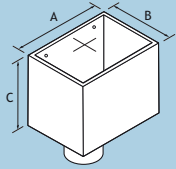
	Pipe Size	A	B	C	Product Code
	86 x 106	250	180	200	HSP/V30/HOP
	111 x 138	250	180	200	HSP/V40/HOP

Note: The products are available in a plain mill finish or with a BBA accredited polyester powder coated finish. Product codes in the tables refer to the mill finish. For polyester powder coated finish please add the suffix /PPC. Sundry items are not included as standard unless otherwise stated. Please order sundry items separately.

Guardian - Square and Rectangular Pipes and Fittings



Guardian Square Pipes are available in 3 square/rectangular sizes and pipe lengths of 2m. Concealed flush fixing ensures that the pipe cannot be scaled. Factory finished in a choice of coloured BBA certificated powder coatings.

Notes: Guardian is a bespoke manufactured range. Contact Alumasc Technical Services for more information.

All dimensions are in mm unless shown otherwise.

Pipes

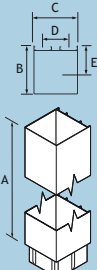
	Pipe Size	Pipe Length (A)	B	C	D	E	Product Code
	80 x 72	2000mm	80	72	41	44	HSP/S33/2MA
	80 x 72	1000mm	80	72	41	44	HSP/S33/1MA
	84 x 102	2000mm	84	102	71	46	HSP/S43/2MA
	84 x 102	1000mm	84	102	71	46	HSP/S43/1MA
	109 x 102	2000mm	109	102	71	59	HSP/S44/2MA
	109 x 102	1000mm	109	102	71	59	HSP/S44/1MA

Access Pipes

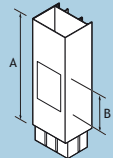
	Pipe Size	A	B	Product Code
	80 x 72	300	150	HSP/S33/ACP
	84 x 102	300	150	HSP/S43/ACP
	109 x 102	300	150	HSP/S44/ACP

Shoe

	Pipe Size	A	B	Product Code
	80 x 72	30	100	HSP/S33/SH
	84 x 102	30	305	HSP/S43/SH
	109 x 102	30	100	HSP/S44/SH

Drain Connector

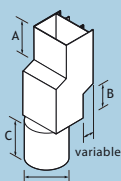
	Pipe Size	A	B	C	D	Product Code
	80 x 72	100	100	100	Variable	HSP/S33/ZADP
	84 x 102	100	100	100	Variable	HSP/S43/ZADP
	109 x 102	100	100	100	Variable	HSP/S44/ZADP

Note: This is a made to order item. Dimensions are required from the wall to the centre of the drain prior to placing an order

Note: The products are available in a plain mill finish or with a BBA accredited polyester powder coated finish. Product codes in the tables refer to the mill finish. For polyester powder coated finish please add the suffix /PPC. Sundry items are not included as standard unless otherwise stated. Please order sundry items separately.

Guardian - Square and Rectangular Pipes and Fittings

Bend

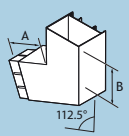
	Pipe Size	A	Product Code
	80 x 72	100	HSP/S33/ZBND
	84 x 102	100	HSP/S43/ZBND
	109 x 102	100	HSP/S44/ZBND
Note: Please specify whether left, right, front or rear is required. Please specify whether 92.5, 112.5 or 135° is required			

Branch

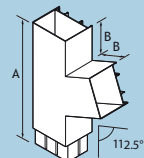
	Pipe Size	A	B	Product Code
	80 x 72	300	100	HSP/S33/ZBRN
	84 x 102	300	100	HSP/S43/ZBRN
	109 x 102	300	100	HSP/S44/ZBRN
Note: Please state whether left or right hand is required. Please specify whether 92.5, 112.5 or 135° is required				

Offset

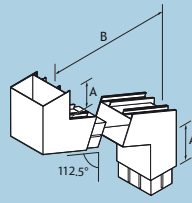
	Pipe Size	Offset	A	B	Product Code
	80 x 72	Up to 305	100	305	HSP/S33/305
	84 x 102	Up to 305	100	305	HSP/S43/305
	109 x 102	Up to 305	100	305	HSP/S44/305
	80 x 72	Up to 533	100	533	HSP/S33/533
	84 x 102	Up to 533	100	533	HSP/S43/533
	109 x 102	Up to 533	100	533	HSP/S44/533
	80 x 72	Up to 762	100	762	HSP/S33/762
	84 x 102	Up to 762	100	762	HSP/S43/762
	109 x 102	Up to 762	100	762	HSP/S44/762
Note: Please specify whether 92.5, 112.5 or 135° is required. Front, left and right offsets also available					

135° Fixed Offsets

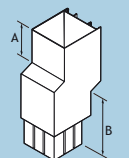
	Pipe Size	Offset	A	B	Product Code
	80 x 72	75	100	100	HSP/S33/75/135A
	84 x 102	75	100	100	HSP/S43/75/135A
	109 x 102	75	100	100	HSP/S44/75/135A

Make-Up Piece

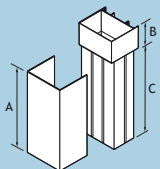
	Pipe Size	A	B	C	Product Code
	80 x 72	340	60	380	HSP/S33/MUP
	84 x 102	340	60	380	HSP/S43/MUP
	109 x 102	340	60	380	HSP/S44/MUP

Contemporary Rainwater Heads

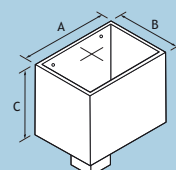
	Pipe Size	A	B	C	Product Code
	80 x 72	250	180	200	HSP/S33/HOP
	84 x 102	250	180	200	HSP/S43/HOP
	109 x 102	250	180	200	HSP/S44/HOP

Note: The products are available in a plain mill finish or with a BBA accredited polyester powder coated finish. Product codes in the tables refer to the mill finish. For polyester powder coated finish please add the suffix /PPC. Sundry items are not included as standard unless otherwise stated. Please order sundry items separately.

Alumasc Rainwater Systems Aluminium Range Installation Procedures

Preparatory requirements and installation methods for the Heritage gutter and pipe system, Aqualine gutter system, GX gutter system, Flushjoint pipe system and Guardian security pipe system.



Aluminium Rainwater System Installation - Introduction

For safe and satisfactory installation of Alumasc rainwater systems, the following good practice guidelines should be reviewed before installation commences. Where unusual or special conditions arise contact Alumasc Technical Services for assistance.

General Preparation and Good Practice

Securely fixed fascia boards must be painted and capable of supporting a fully loaded gutter. Check fascia for straightness and whether shims will be necessary to align brackets without creating stress at gutter joints. Where fascia boards are not being used Alumasc provide top and side fix rafter arm brackets as well as masonry drive-in brackets.

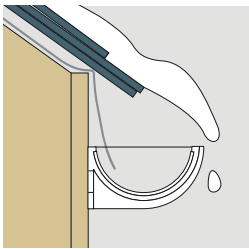

Fix brackets so as to position the gutter centrally and as close below the roof edge as possible, taking into consideration locality and roof slope finish. If there is a risk of sliding snow, adjust the bracket positions to prevent snow hitting the front of the gutter. Extra fixings, brackets and snowboards should be considered where appropriate.

Where high winds are expected, a small bead of sealant must be applied between gutter and brackets a flexible adhesive. An occasional screw, fixed through a slot in the back of the gutter and into the fascia may be preferred, at a minimum of two per length.

Alumasc advise that the designer and contractor satisfy themselves that the application is suitable.

Setting Out

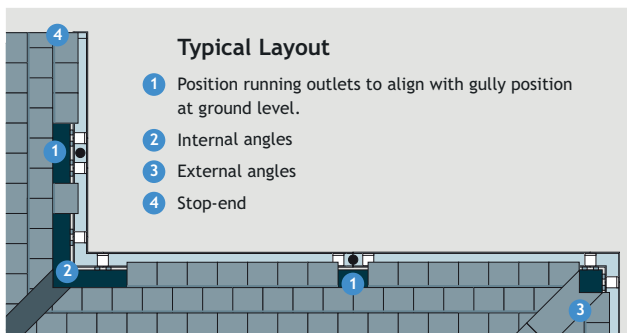

After setting out angles and outlets, fit gutters and brackets according to installation procedures for the specific rainwater system being used, as detailed in this brochure.

Cutting and Drilling

Aluminium can be cut and drilled on site with regular metalworking tools. Pencil cut lines and apply masking tape either side of cut line to protect against accidental saw damage.

Site Painting

Degrease with white spirit and clean thoroughly. Prime with zinc phosphate or similar aluminium primer, followed by at least two coats of full gloss paint on all exposed surfaces. Undercoating is not required. Where powder coated materials have been cut, it is necessary to deburr exposed edges and follow the above painting procedure.

Health and Safety

Always refer to current Health and Safety legislation, safe systems of work and the relevant material safety data sheets.

Storage and Handling

Colour coated rainwater gutters and pipes must be handled with care to prevent scratches and dents. Materials should be stored on a level surface or racking, preferably under secure cover. Uneven fading or water marks on coated and mill finish surfaces may occur if water enters protective packing or goods are stored exposed to sunlight.

Mill finish goods will have manufacturing blemishes such as grinding and fettling marks, welding will be visible on fabricated items and extruded/pressed aluminium items may also be vulnerable to scratch marks or blemishes caused in-transit. It is recommended mill finish material is painted on-site.

Store seals and sealants under cover and make secure and separate provision for solvents. Dispose of packing materials responsibly.

Testing

Allow sufficient time for sealant joints to fully cure. Check all bracket and gutter fixings are secure and plug outlets. Fill up to overflow level (but not beyond). Allow 5 minutes before inspecting all joints for leaks.

Care and Maintenance

Regularly clean out rainwater heads and gutters and ensure that downpipes are clear. Check joints and fixings are secure by periodic inspection no less than twice a year, preferably at the start of Autumn and end of Winter.

Mill finish goods will develop a protective grey aluminium oxide, however it is recommended mill finish material is painted on-site. Polyester powder coated surfaces can be cleaned by washing with warm detergent solution and leathering off.

Aluminium rainwater systems installed in a coastal environment can be subject to harsh atmospheric conditions that can accelerate the oxidation process. Alumasc do not normally recommend using aluminium rainwater systems in such locations. However, applying a double coat of polyester powder coating prior to despatch, together with a strict and frequent maintenance regime, should result in the product having a life expectancy in excess of 15 years.

NB: This life expectancy depends on any installation damage being repaired immediately with appropriate touch-up paint, as should any site-cut ends exposing bare metal, which must be de-burred and then repainted in accordance with Alumasc's site painting procedure.

Please contact Alumasc Technical Services for further information.

Installation - Heritage Gutters

Heritage gutters are available in a choice of five profiles with a range of brackets to accommodate all types of eaves condition. Each profile range can be connected to aluminium pipework systems in either round, square or rectangular sections secured by standard and offset brackets. Assembly and installation of each profile range must be considered individually, although general aspects of preparation are common to them all as shown below.

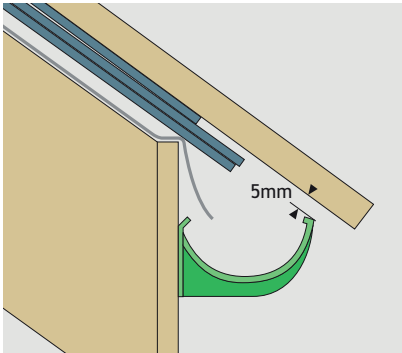

1. Using a straight edge or ruler, shim gutter brackets with 5mm clearance so that the last roof tile or slate will align with the mid point of the gutter.

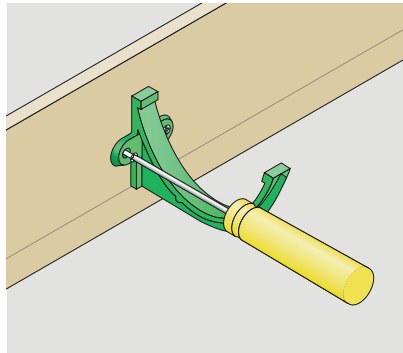

2. Generally, position brackets at 915mm centres. Allow at least 2 brackets per gutter length, 1 per angle and outlet.

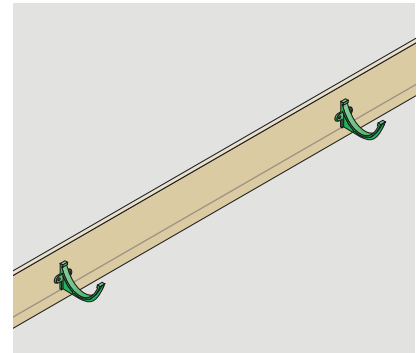

3. Use a string line to set out brackets to a fall of 1:600 to 1:350 (max) or if not possible, level.

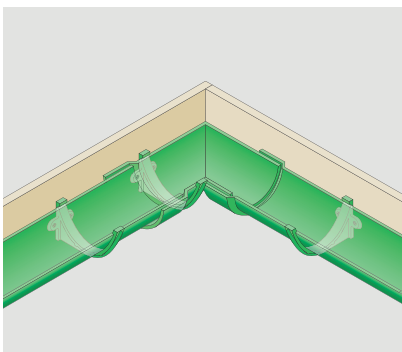

4. Plumb line outlets with gullies at ground level. Position angles, allowing an additional bracket adjacent to the joint with the gutter length.

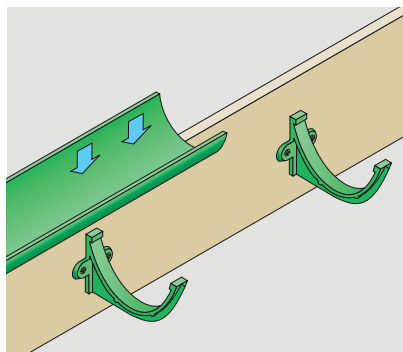

5. Lower the gutter onto the brackets ensuring sufficient clearance for the gutter joint. Clip gutter into bracket.

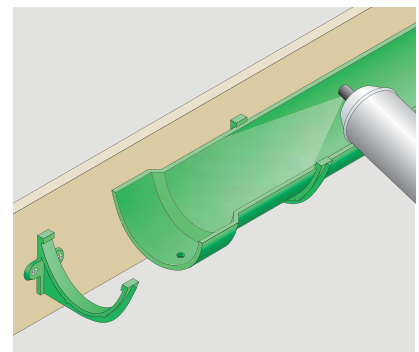

6. Cast gutters overlap at the joint with a spigot and socket. Thoroughly clean and degrease the ends that must be jointed.

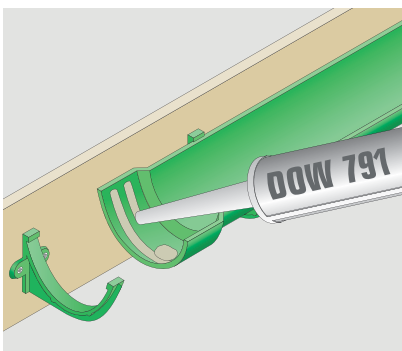

7. Apply two 6mm beads of DOW 791 silicone sealant either side of, and around the fixing hole.

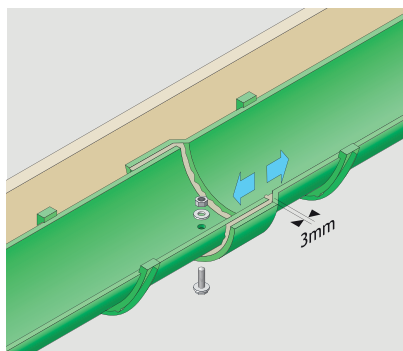

8. Insert the spigot end of the gutter allowing a 3mm expansion gap. Secure joint using aluminium M6 x 20mm nut, bolt and washer provided. (Bolt head preferably to underside).

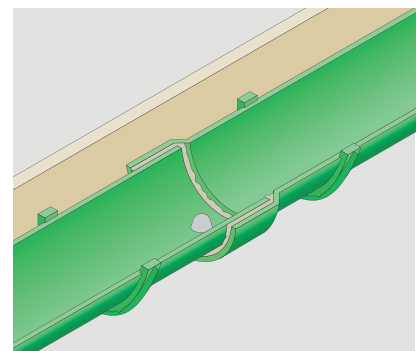

9. Finally, cone-off the exposed bolt stud and nut inside the gutter with a generous application of silicone sealant. Tool off excess silicone around the joint and from external surfaces.

Installation - Heritage Rainwater Pipes

Heritage traditional rainwater pipes have cast pipe sockets either with ears for wall fixing or without for use with pipe clips. Installation is generally from the eaves downward.

Where sockets are supplied separately these must be lightly driven home into the rainwater pipe using a softwood block or adequate protection at the pipe end to prevent damage. Saw cuts must be square and free from dents and burrs. A light application of silicone sealant must be applied to both surfaces to ensure a waterproof seal.

Pipe Alignment

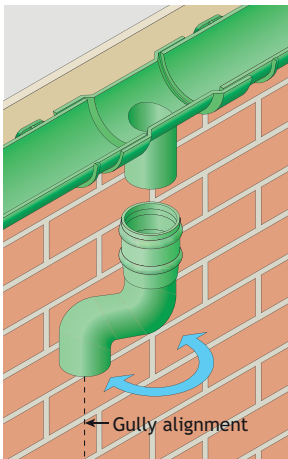

Where square or rectangular pipes are being installed and offsets are required, alignment between the gutter outlet and gully must be exact.

Round pipe systems are more flexible to install and offsets can be adjusted and "swung" into alignment with the gully position.

Outlets and Offsets

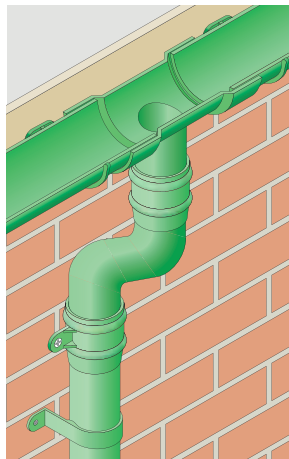

Commence installation from the gutter outlet by fitting and adjusting the one part or two part offsets.

Check vertical plumb line positioning and seal spigot and socket joints using DOW791 silicone sealant.

Pipe Jointing and Fixing

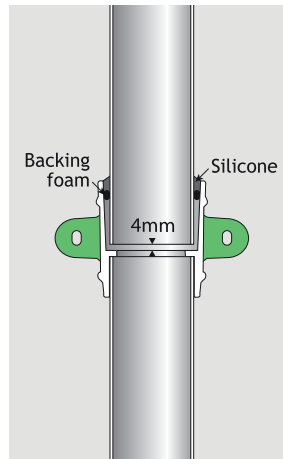

Allow a 4mm expansion gap between pipe end and socket, and insert a 6mm backing foam into the pipe joint. Seal with DOW 791 silicone sealant.

Fix to wall at 2m centres using No12 x 50mm screws. Eared sockets have elongated fixing holes to permit the use of pipe nails.

Tools Required

- String or plumb line
- Tape measure
- Drill
- File
- Masonry bit
- Wall fixing (e.g raw plug)
- Cleaning rags
- Marker pen
- Solvent cleaner
- Posi and plain screwdriver
- Paintbrush
- Hacksaw
- Masking tape
- Mastic gun
- Spirit level
- Protective gloves
- Adjustable spanner

General Installation Sequence

- Complete installation of gutters; alternatively, locate rainwater heads
- Position offsets, bends and branches
- Fit pipes and brackets
- Fit plinth offsets
- Fit access doors and shoes

Sealant

For durable all weather seals and best results, Alumasc recommend the use of DOW 791 silicone sealant.

Rainwater Heads

Fix to masonry through external lugs or preformed holes in back.

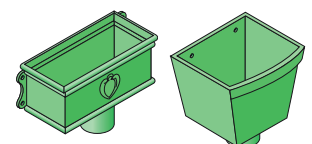

Pipe Clips

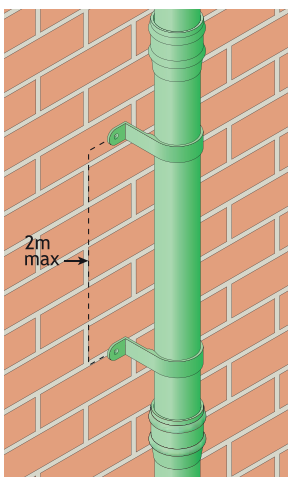

Where uneared pipework is being used it must be secured at maximum 2m centres.

Pipe clips should be chosen according to visual or practical considerations and comprise Standard Base, Small Base and Extended Base options.

Bends and Branches

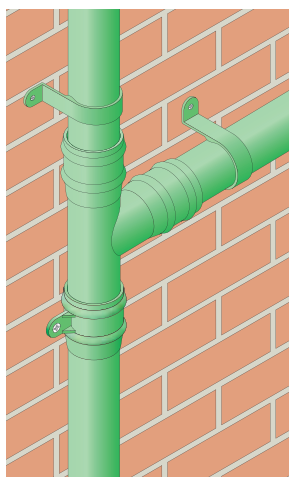

Bends and branches are secured into the pipe socket. Where additional fixing is required e.g a change of direction at a bend, use additional pipe clips.

Shoes and Access Pipes

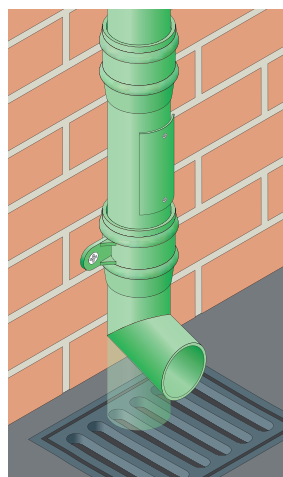

At ground level rainwater pipes can terminate with a shoe for free discharge over a gully or be directly connected into the gully. In the case of direct connections it is recommended that an access pipe fitting is included within 750mm of ground level.

Installation - Aqualine Gutter and Bracket Preparation

Aqualine gutters are available in five profiles which are supported on secret fix brackets. Joints are made flush using dry seals and slide locks. As a dry jointed system, each gutter profile range is supplied with the required components to achieve a successful installation. Refer to the Rainwater System Installation Guidance on page 97 and review the information below before fitting the Aqualine gutter range.

Joining Tool

The joining tool is used to compress the gutter seals whilst positioning slide locks.

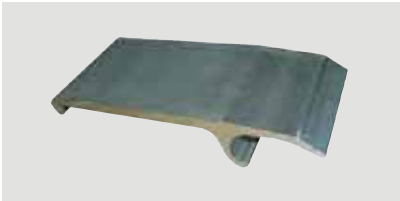

Slide Locks

Seen here are the 3 types of slide lock (depending on rainwater system) shown positioned as they would be inserted.

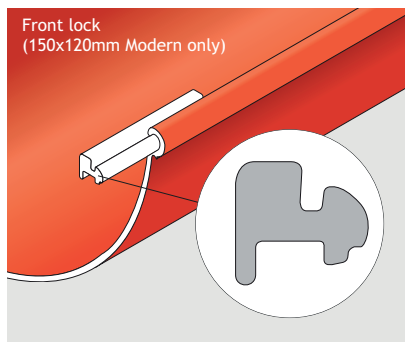
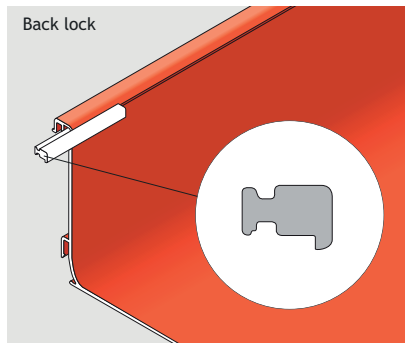
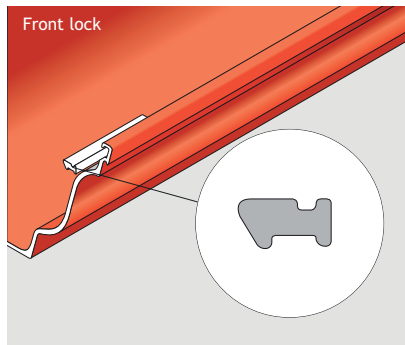

Aqualine Brackets

There are two types of Aqualine gutter bracket depending on the Aqualine gutter profile to be installed.

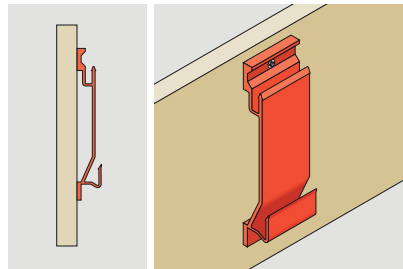

Bracket for Half Round and Deep Run gutters
(Supplied to colour match gutter)

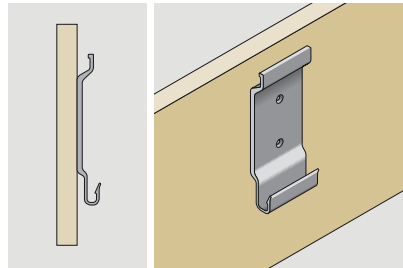

Bracket for Modern, Moulded and Box gutters
(Supplied mill finish)

Aqualine Starter Pack

Starter Packs contain essential installation items.

- P80 joint seal lubricant
- 2 x joining tool
- 10 x spare slide locks
- 20 x spare No 12 screws
- 8 x spare seal strips
- 20 x shims

When unpacking locate the Aqualine Starter Pack and keep in a safe place.

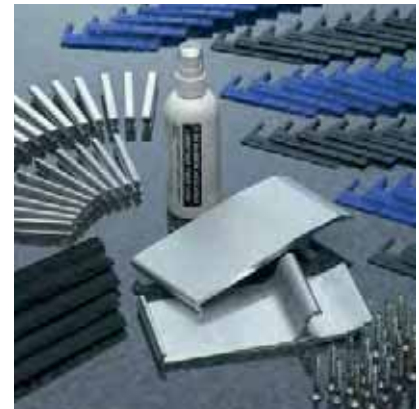

Aqualine starter pack

Setting Out

As a guide there would be 4 brackets per 3m length. Position angles using 2 brackets per angle inset 150mm from each open end. Position outlets using 1 bracket inset 75mm from open end. At gutter ends where there is no outlet, position 1 bracket inset 150mm.

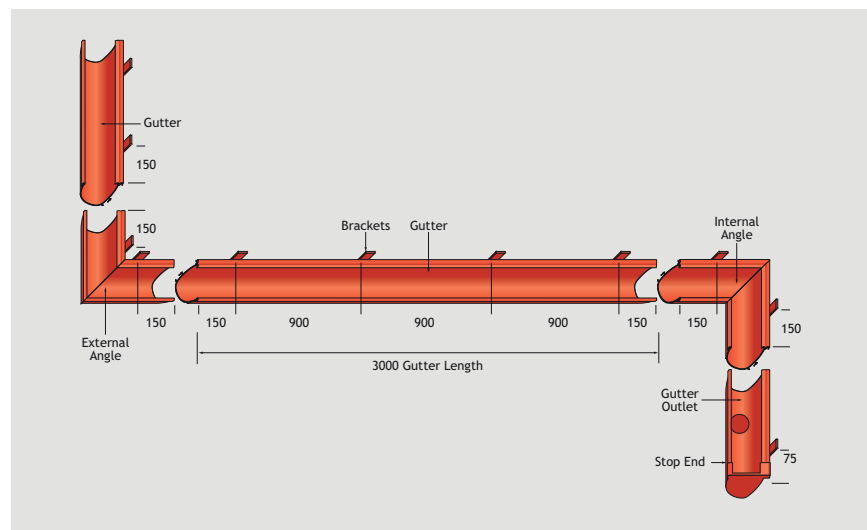

Installation - Aqualine Gutter and Bracket Preparation

Aqualine gutter systems are supported on concealed bracketry which requires pre-painted fascia boards to be straight and level. The use of shims provided in the Aqualine Starter Packs assists bracket alignment and improves gutter connections whilst minimising stress within the joints. As a guide there are 4 brackets per 3 metre gutter length. Position angles using 2 brackets per angle, inset 150mm from each open end. Position outlets using 1 bracket inset 75mm from open end. At gutter ends where no outlet exists, position 1 bracket inset 150mm.

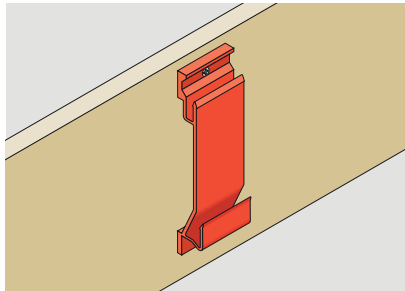
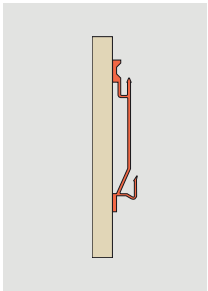

Bracket for Half Round and Deep Run gutters.

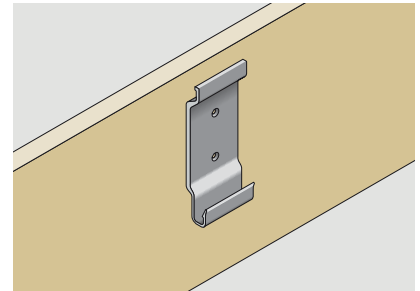
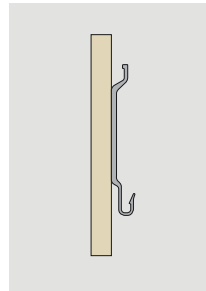

Bracket for Modern, Moulded and Box gutters.

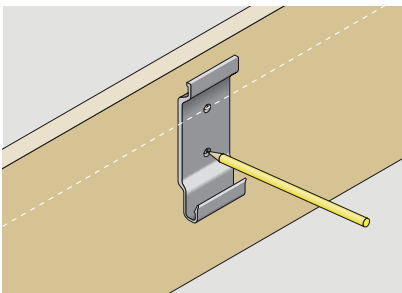

1. Use a string line or laser to set out brackets. (Aqualine must be laid level).

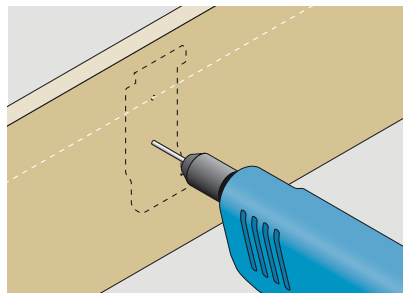

2. Position and pilot 3.5mm diameter hole.

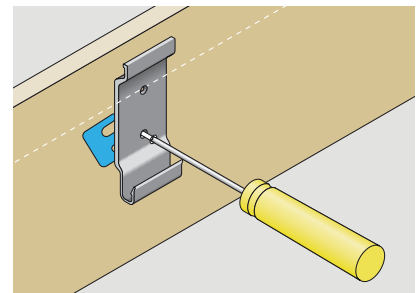

3. Lightly tighten and shim if necessary to align plumb. Fix using No12 x 38mm roundhead screws.

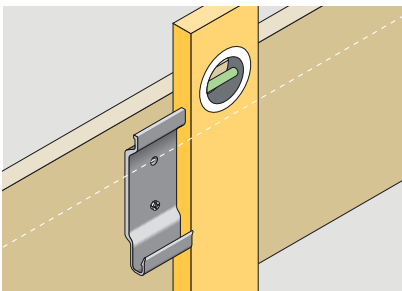

4. Set square.

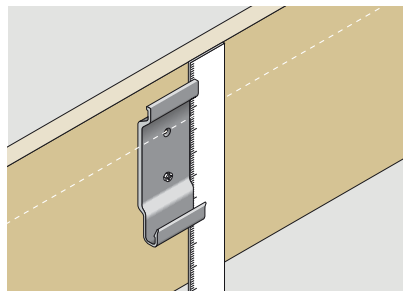

5. Check positioning and adjust if necessary.

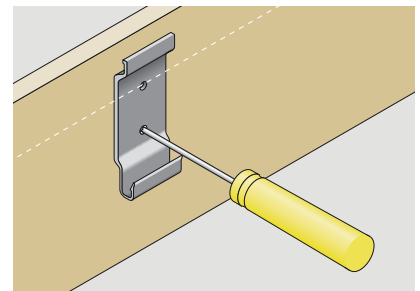

6. Tighten.

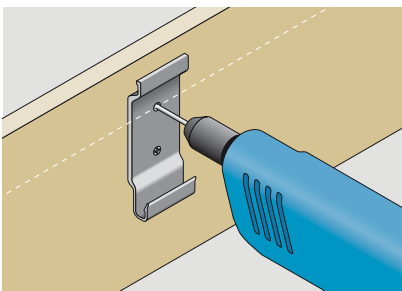

7. Pilot 3.5mm diameter hole.

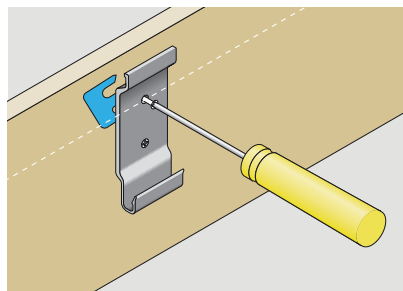

8. Check for plumb, shim if necessary and tighten.

Installation - Aqualine Half Round, Deep Run and Modern Gutters

Aqualine Half Round, Deep Run and Modern gutters use a unique dry jointing system to give a completely clean external appearance. Gutters drop and lock onto concealed brackets where internal joints are aligned and locked using slide bars. Assembly of Half Round, Deep Run and Modern gutters requires the use of single front lock bars. The entire gutter system is completely secure whilst at the same time allowing free linear thermal movement.

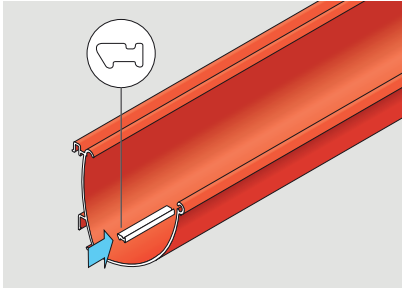

1. Pre-insert slide lock bars (1 per joint). Check for right way up.

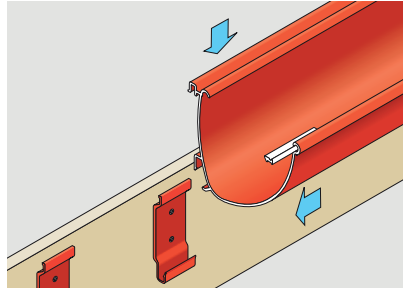

2. Position gutters loosely, do not lock down.

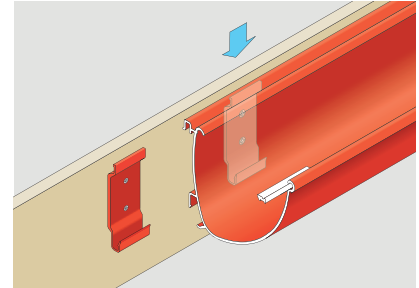

3. Locate gutters onto top rail of brackets and allow 4mm gap.

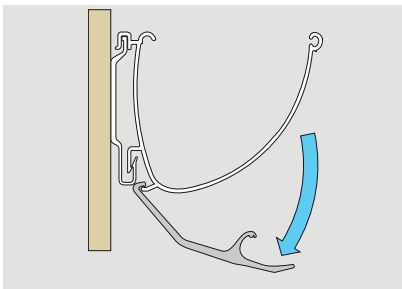

4. Lock down gutter with Aqualine jointing tool.

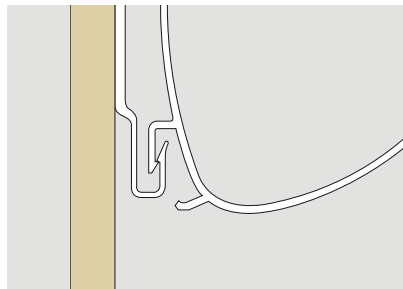

5. Check for positive location.

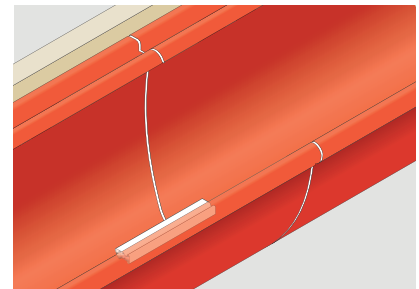

6. Slide lock bar within 50mm of joint but NOT across gutter joint.

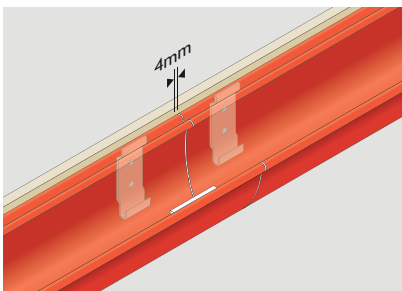

7. Check and reset 4mm expansion gap as necessary.

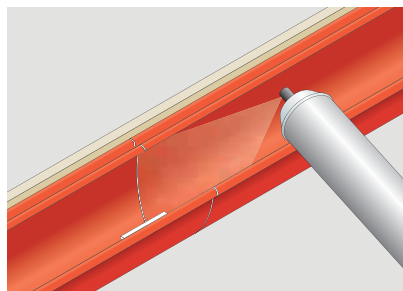

8. Clean jointing surfaces and spray apply Alumasc lubricant.

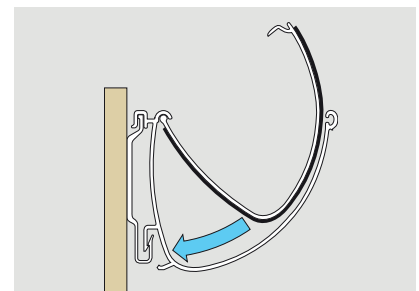

9. Hook joint union into gutter receiver channel and pivot down.

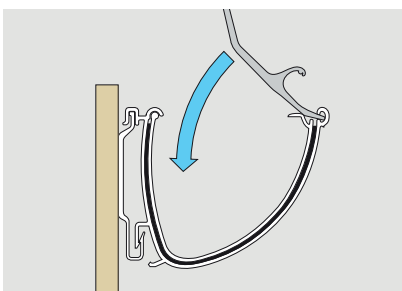

10. Compress joint union and start lock bar across joint.

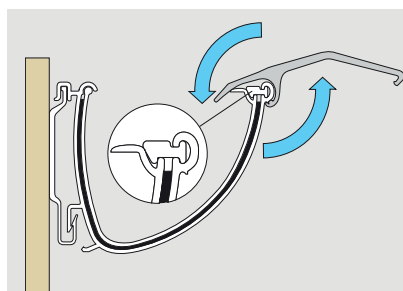

11. Reverse tool apply **equal** pressure around **pivot** point to complete lock bar positioning fully across joint. Take care not to dislodge gutter from fascia bracket.

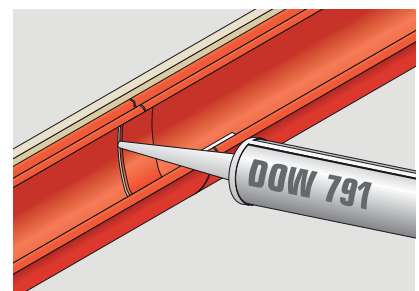

12. Dry gutter and apply DOW 791 silicone sealant to weather edges of union.

Installation - Aqualine Moulded and Box Gutters

Aqualine Moulded and Box gutters use a unique dry jointing system to give a completely clean external appearance. Gutters drop and lock onto concealed brackets where internal joints are aligned and locked using slide bars. Assembly of Moulded and Box gutters requires the use of lock bars located at the front and rear. The entire gutter system is completely secure whilst at the same time allowing free linear thermal movement.

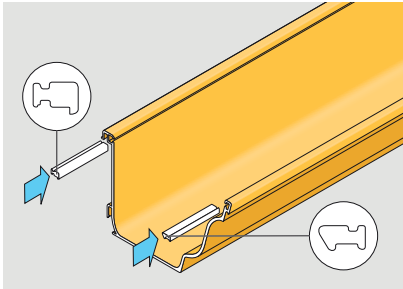

1. Pre-insert slide lock bars front and rear. Check for right way up.

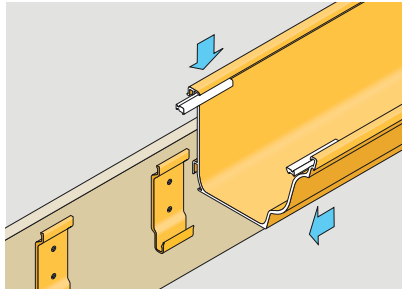

2. Position gutters loosely, do not lock down.

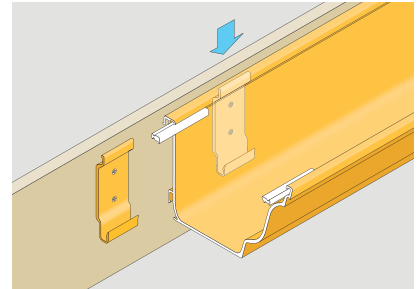

3. Locate gutters onto top rail of brackets and allow 4mm gap.

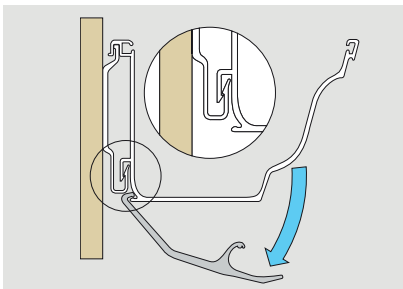

4. Lock down gutter with Aqualine jointing tool and check for full location.

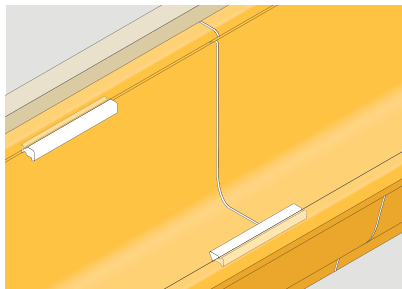

5. Slide lock bars up to but NOT across gutter joint.

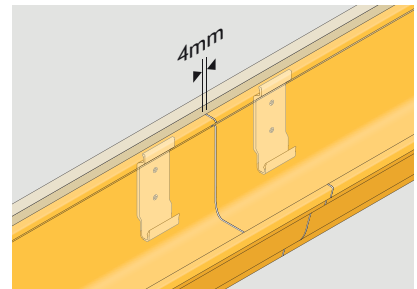

6. Check and reset 4mm expansion gap as necessary.

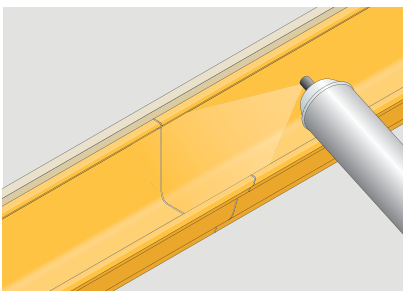

7. Clean jointing surfaces and spray apply Alumasc lubricant.

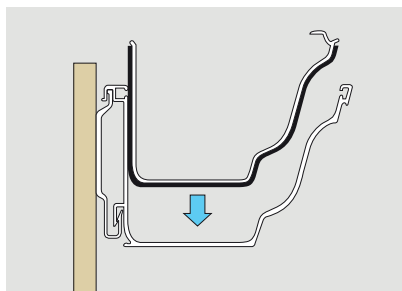

8. Push in joint union from above.

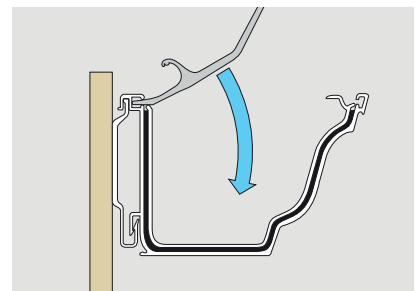

9. Compress joint union (back) and slide rear lock bar fully across joint.

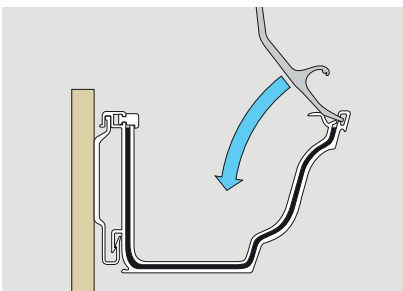

10. Compress joint union (front) and start front lock bar across joint.

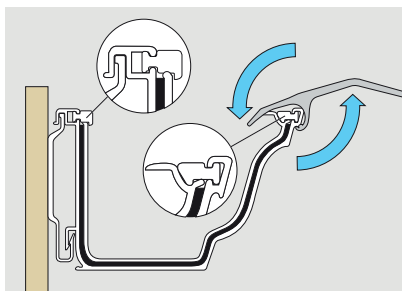

11. Reverse tool apply equal pressure around pivot point to complete lock bar positioning fully across joint. Take care not to dislodge gutter from fascia bracket.

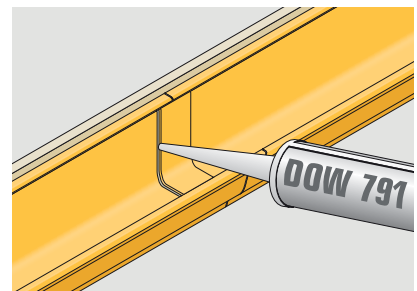

12. Dry gutter and apply DOW 791 silicone sealant to weather edges of union.

Installation - AX Moulded Gutters, Direct Fixing

AX Moulded gutters comprise extruded aluminium profiles, jointed with internal union clips. Profiles can be connected to aluminium pipework systems in either round, square or rectangular sections. AX Moulded gutters can be installed by direct fix to the fascia, or by means of support brackets. Assembly and installation must be considered with specific reference to site fixing conditions, but general aspects of preparation are shown below. This guide covers direct fixing. For bracket fixing, see separate installation guide.

General fixing instructions

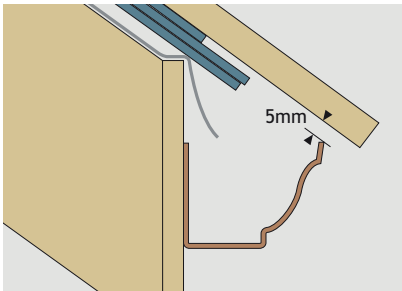

- Using a straight edge or ruler, shim gutter brackets with 5mm clearance so that the last roof tile or slate will align with the mid point of the gutter.

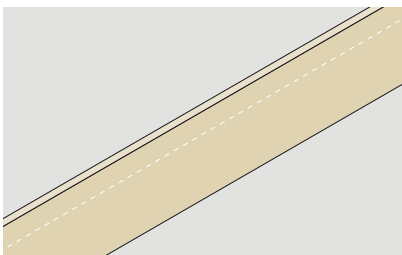

- Using a string or laser, establish a true line of the gutter.

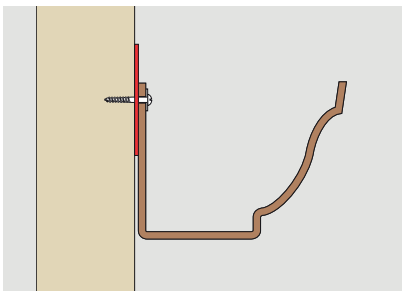

- Note any uneven surfaces on the fascia and make adjustments if possible. Where shallow depressions occur, packing pieces can be used under gutter lengths.

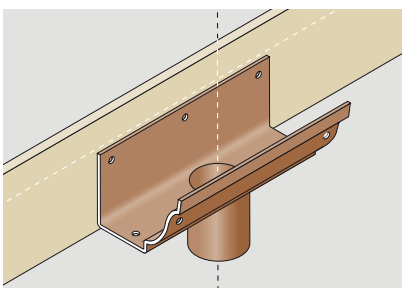

- Plumb line outlet positions with gullies at ground level

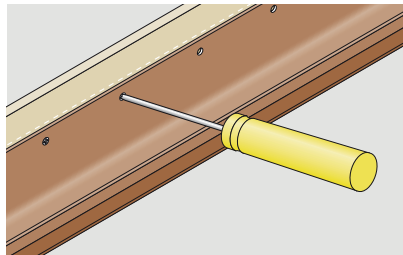

- Fix all components and gutter lengths direct to the fascia with a single round-head screw through the back edge at 900mm centres. Drill 8mm holes 18mm from the top edge.

Method of jointing

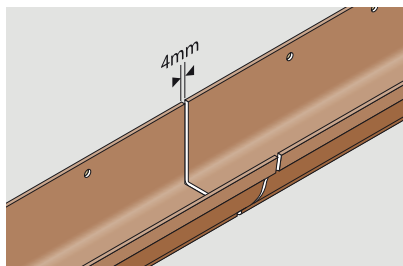

- When joining gutter lengths, allow for a 4mm expansion gap.

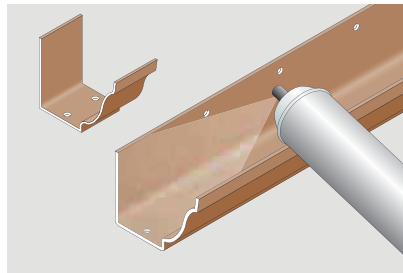

- De-grease and clean each union and gutter length/fitting to a distance of 50mm - 100mm from the end.

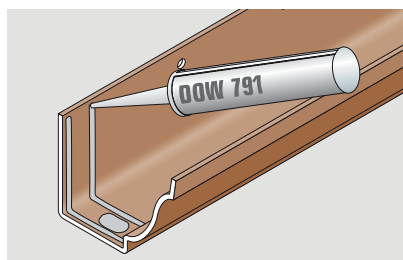

- Apply two 6mm beads of Dow Corning 791 low-modulus Type A silicone sealant either side of, and around the fixing holes. Silicone sealant must be applied only to completely dry surfaces.

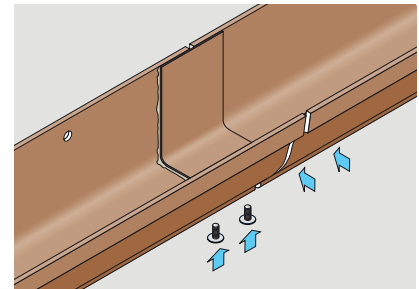

- Secure the union to the gutter using the M6 x 20mm aluminium nuts, bolts and washers supplied. Pass bolt from outside in, and use washer and nut to secure finger-tight.

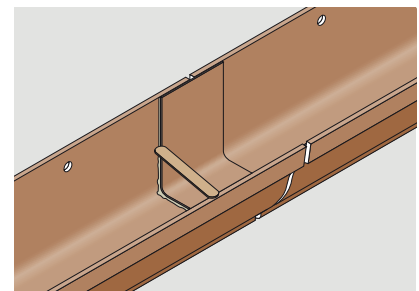

- Tool-off displaced silicone sealant to the inside of the gutter joint. Tighten fixing bolts. Cone-off bolts and any other potential leakage points with sealant. Allow to cure for 24 hours.

Finishing

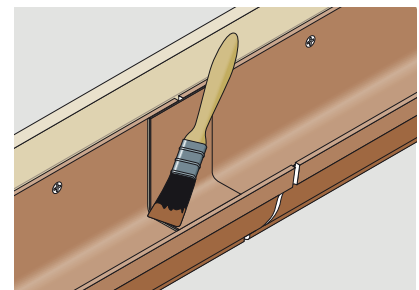

- Use touch-up paint on all exposed nuts, bolts and washers.

Installation - AX Half Round and Moulded Gutters, Bracket Fixing

AX Half Round, Deep Run and Moulded gutters comprise extruded aluminium profiles, jointed with internal union clips. A range of brackets is available to accommodate all types of eaves condition. AX profiles can be connected to aluminium pipework systems in either round, square or rectangular sections secured by standard or offset brackets. The installation procedure is the same for AX Half Round, AX Deep Run and AX Moulded gutters.

General fixing instructions

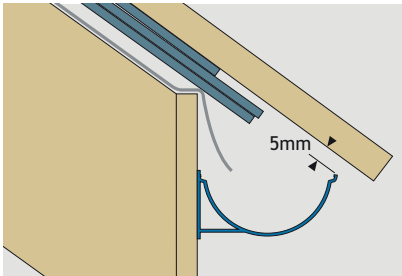

1. Using a straight edge or ruler, shim gutter brackets with 5mm clearance so that the last roof tile or slate will align with the mid point of the gutter.

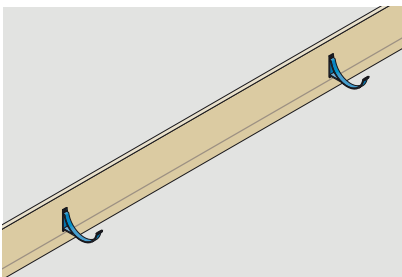

2. Use a string or laser to establish a true line and level of the gutter. Prepare to use packing pieces under brackets where there are depressions.

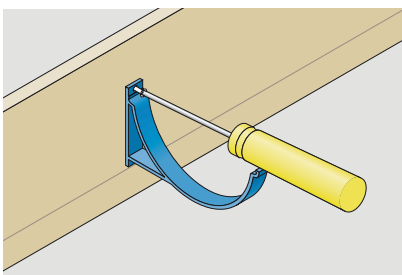

3. Generally position fascia brackets at 900mm centres in accordance with BS EN 12056-3:2000. Fix brackets with two No 12 x 38mm round-head screws.

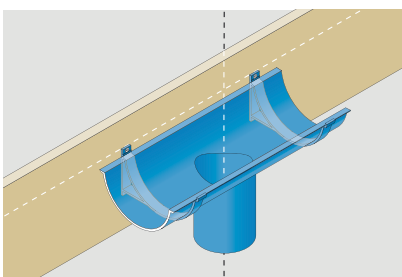

4. Plumb line outlet positions with gullies at ground level.

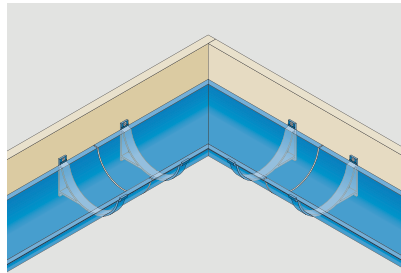

5. Offer angle pieces and outlets to the fascia. Lower gutter sections onto the brackets leaving a 4mm expansion gap between gutter sections and allow sufficient clearance for the gutter joint.

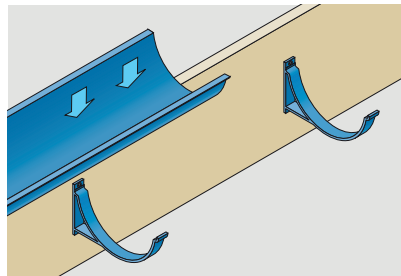

6. Clip gutter sections into brackets.

Method of jointing

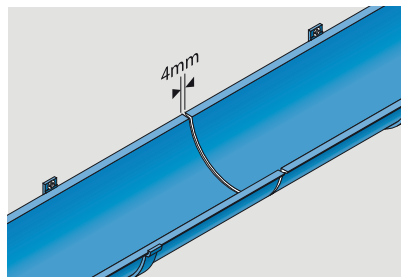

7. When joining gutter lengths, allow for a 4mm expansion gap.

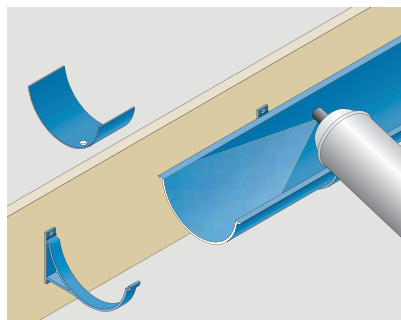

8. De-grease and clean each union and gutter length/fitting to a distance of 50 - 100mm from the end.

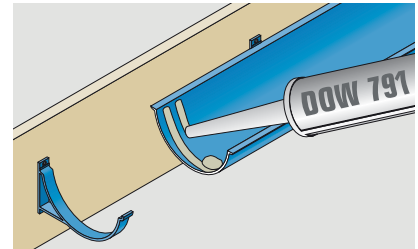

9. Apply two 6mm beads of Dow Corning 791 low-modulus Type A silicone sealant to the ends of gutter profiles and fixing hole. Silicone sealant must be applied only to completely dry surfaces.

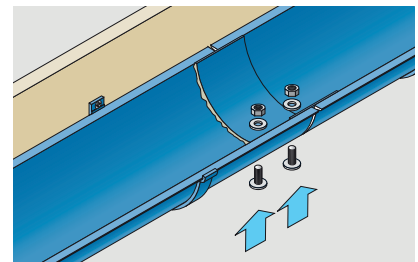

10. Secure the union to the gutter using the M6 x 12mm aluminium nuts, bolts and washers supplied. Pass bolt from outside in, and use washer and nut to secure finger-tight.

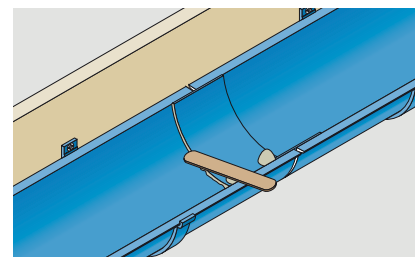

11. Tool-off displaced silicone sealant to the inside of the gutter joint. Tighten fixing bolts. Cone-off bolts and any other potential leakage points with sealant. Allow to cure for 24 hours.

Finishing

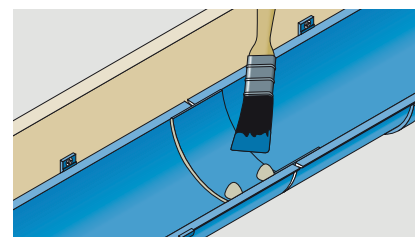

12. Use touch-up paint on all exposed nuts, bolts and washers.

Installation - GX Gutter Preparation

The GX range consists of three gutter profiles designed for managing high volumes of rainwater. GX gutters use traditional wet jointing on site, concealed internal laps and profile specific bracketry for support. High capacity GX systems require the strength and support of internal top straps or “back fixing” directly to fascia boards. Installers should inspect fascia boards to ensure they are capable of carrying the full gutter load.

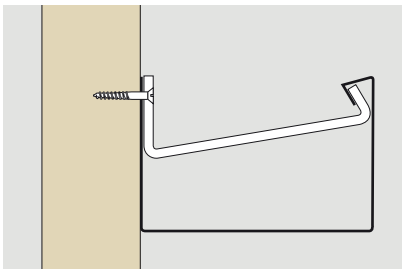

GX Joggle (GXJ)

Screw fixes to the fascia incorporating a heavy gauge top strap.

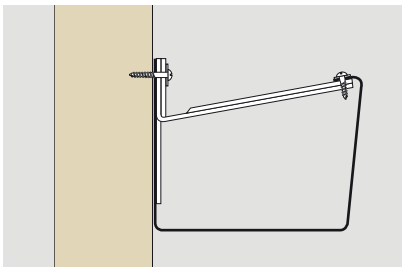

GX Smooth (GXS)

Fascia fixed using a one piece combined top and back strap.

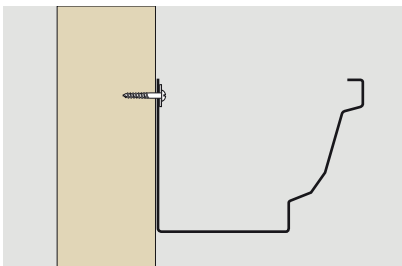

GX Moulded (GXM)

Direct back fix system with option for top strap where large sizes and heavy loads are anticipated.

Note

If snow loads or high winds are anticipated insert two additional screws per length at the centre of each slot.

Alumasc recommend the use aluminium washers to allow for thermal movement.

Sealing washers should be used if there is a risk of leakage during high flow conditions.

Setting Out

Follow the guidelines below for setting out:

- GX Joggle - GXJ1, GXJ2, GXJ3 - Fix at 1000mm centres, GXJ4 and GXJ5 - Fix at 600mm centres using pre-drilled holes provided
- GX Smooth - Fix at 1000mm centres using pre-drilled holes provided
- GX Moulded - Fix at 600mm centres using pre-drilled holes provided
- 2no fixings per angle
- 1no fixing per running outlet

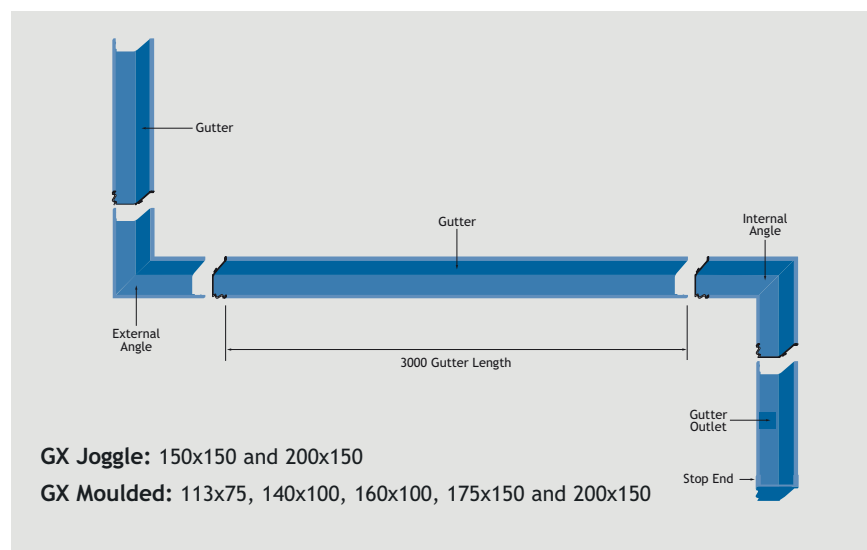
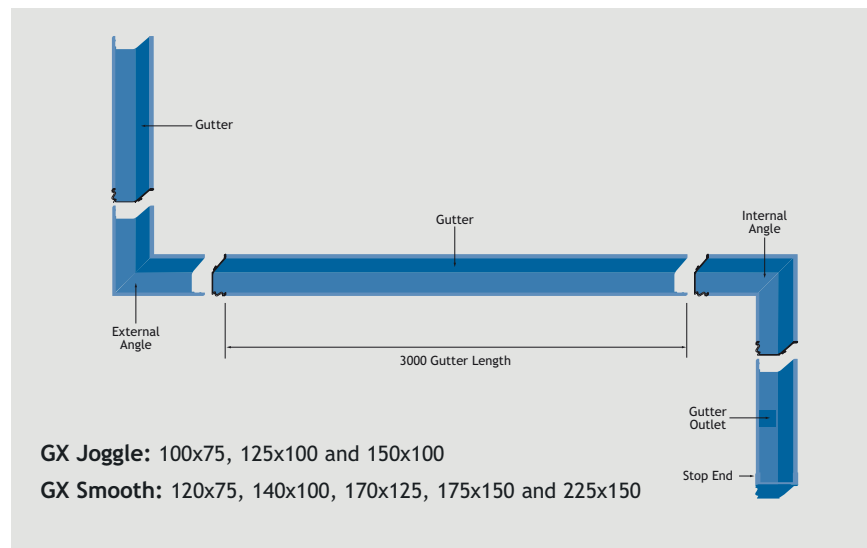

Sealant

For durable all weather seals and the best results, Alumasc recommends the use of DOW 791 silicone sealant.

Installation - GX Joggle Gutter

GX Joggle gutters are a press formed eaves drainage system with sharply defined box profile. Gutters are supported by internal top straps and directly fixed to the fascia board. The Joggle method of gutter jointing uses an integral internal union or formed spigot which is wet sealed using silicone sealant.

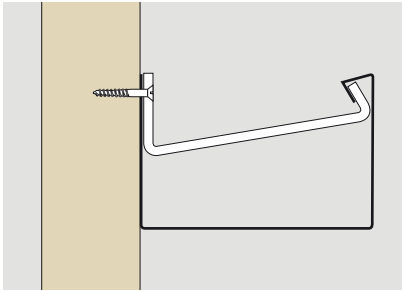

GX Joggle fixes to fascia using a heavy gauge top strap.

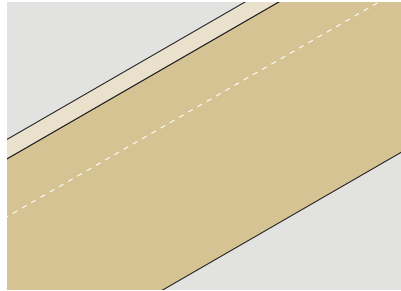

1. Use a string line or laser to set out gutter lines. (GX Joggle must be laid level).

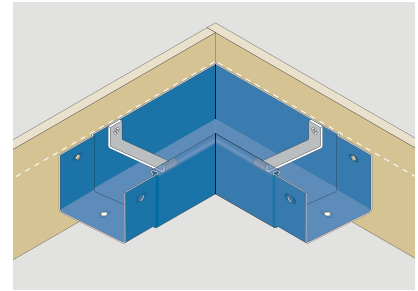

2. Position angles, mark fixing positions and pilot 3.5mm diameter holes, fit top strap and loosely fix using No12 x 38mm roundhead screws.

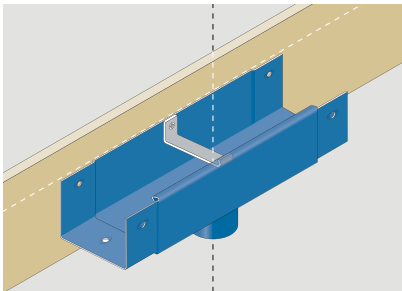

3. Plumb line outlet position with gullies at ground level, pilot 3.5mm diameter holes, fit top strap and loosely fix using No12 x 38mm roundhead screws.

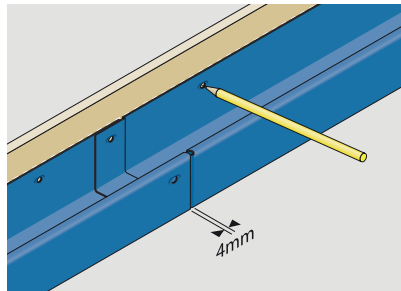

4. Position gutter lengths allowing for 4mm expansion joints. Mark fixing positions and pilot 3.5mm diameter holes.

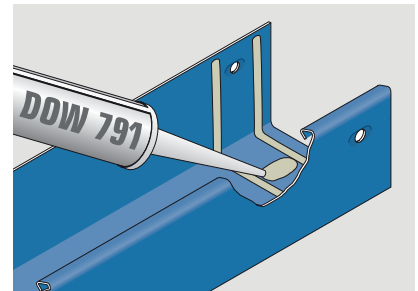

5. Thoroughly degrease all jointing surfaces and apply two 6mm beads of DOW 791 silicone sealant either side of and around the slotted fixing holes.

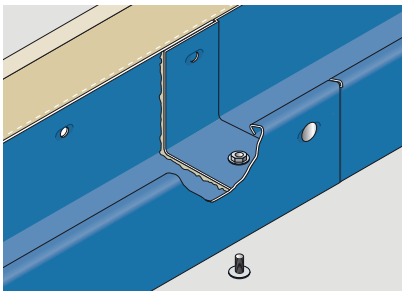

6. Secure joints with aluminium M6 x 12mm nuts, bolts and washers provided taking care not to over tighten or displace sealant from within the joint.

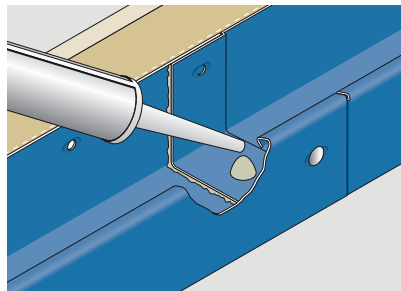

7. Cone-off the exposed bolts, studs and nuts inside the gutter with a generous application of silicone sealant.

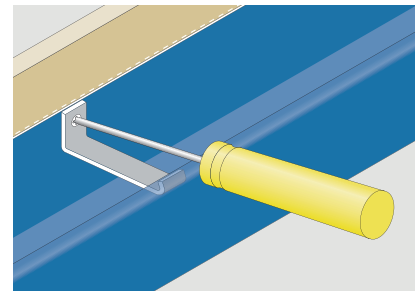

8. Align gutter lengths correctly for final positioning. Engage top straps and fix back securely to fascia.

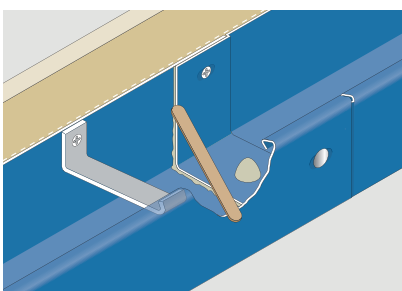

9. Tool off excess silicone around the union joint and from visible external surfaces.

Installation - GX Smooth Gutter

GX Smooth is a press formed rectangular profile with inclined front face. Gutters are supported using a one piece top strap combined with a back strap to accommodate increased weight load. Gutters and fittings are butt jointed with an overlapping union which is wet sealed using silicone sealant and back fixed to the fascia.

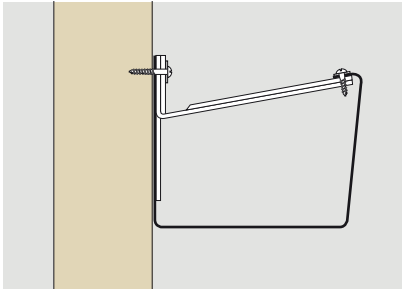

GX Smooth fixes using a one piece combined top and back strap.

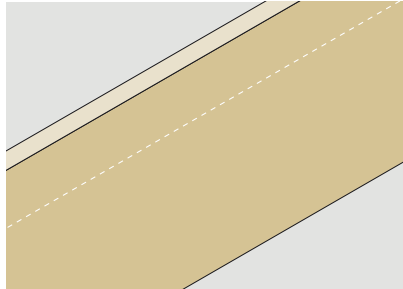

1. Use a string line or laser to set out gutter lines. (GX Smooth must be laid level).

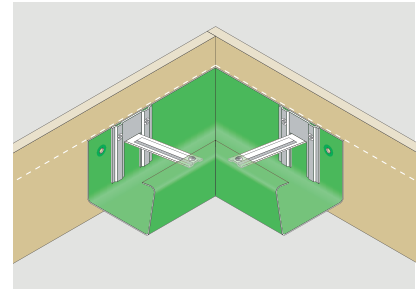

2. Position angles, mark fixing positions and pilot 3.5mm diameter holes. Loosely fit using No12 x 38mm round head wood screws and washers provided.

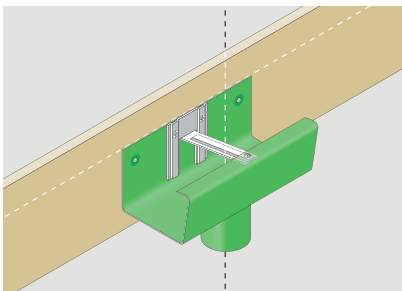

3. Plumb line outlet positions with gullies at ground level and mark fixing positions. Pilot 3.5mm diameter holes and loosely fit using No12 x 38mm round head wood screws and washers.

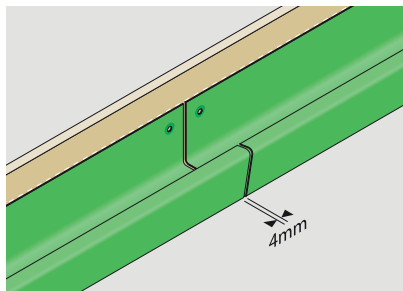

4. Line and level gutter lengths allowing 4mm expansion gap at joints.

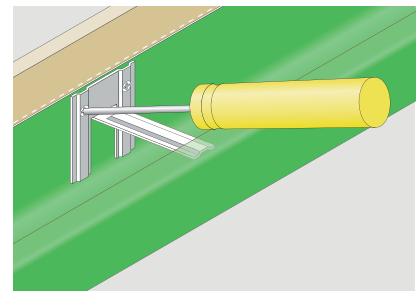

5. Fix gutters to fascia using combined top/back straps and No12 x 38mm round head wood screws and washers provided.

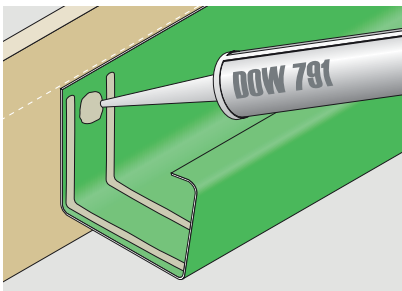

6. Thoroughly degrease all jointing surfaces and apply two 6mm beads of DOW 791 silicone sealant across back/sole/front surfaces.

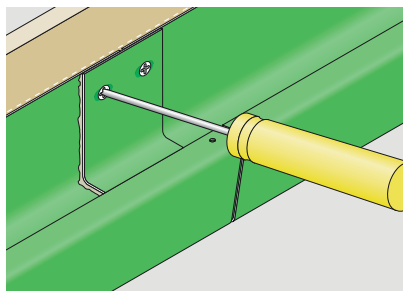

7. Slide in union joints and back fix to fascia board using No12 x 38mm round head wood screws and washers. Slide in next gutter and repeat process.

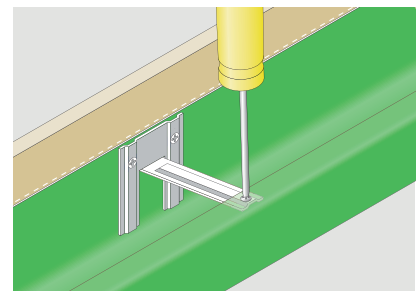

8. Screw the front end of the top straps to the preformed holes in the top lip of the gutter. Use the pan head fixing screw provided.

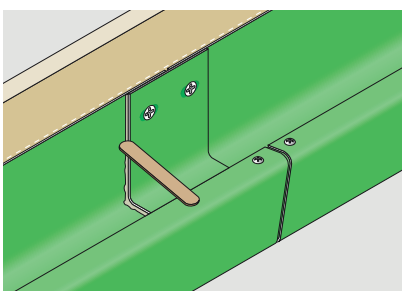

9. Tool off excess silicone around the union joint and from visible external surfaces.

Installation - GX Moulded Gutter

GX Moulded gutters are press formed to provide a seamless moulded profile. GX Moulded gutter systems are generally back fixed directly to the building fascia although the largest profiles also employ top straps. Gutter lengths and fittings are butt jointed with bolted overlapping unions which are wet sealed using silicone sealant.

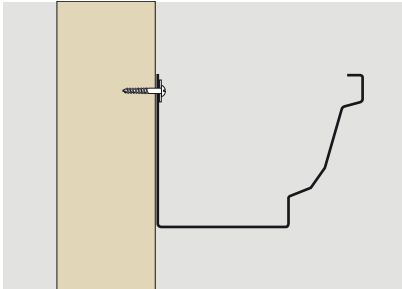

GX Moulded direct fixes to fascia. Top strap options are available where large sizes and heavy loads are anticipated.

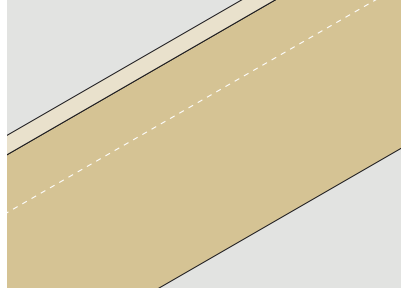

1. Use a string line or laser to set out gutter lines. (GX Moulded must be laid level).

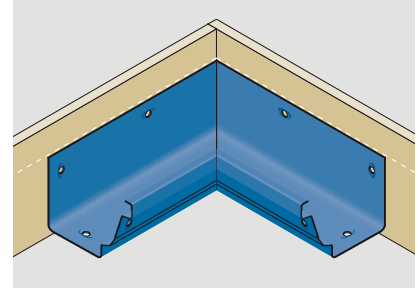

2. Position angles, mark fixing positions and pilot 3.5mm diameter holes and loosely fit using No12 x 38mm round head wood screws and washers provided.

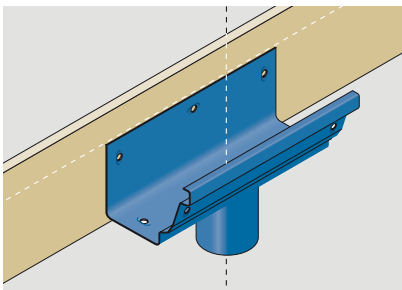

3. Plumb line outlet positions with gullies at ground level and mark fixing positions. Pilot 3.5mm diameter holes and loosely fit using No12 x 38mm round head wood screws and washers provided.

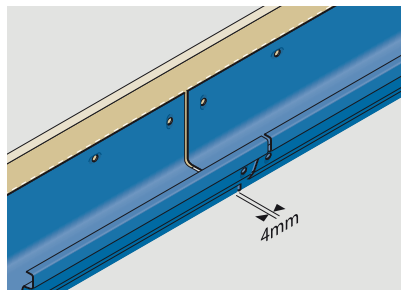

4. Line and level gutter lengths allowing for 4mm expansion gaps at joints.

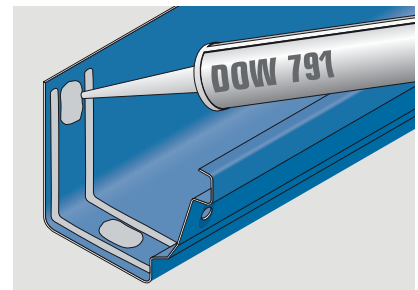

5. Thoroughly degrease all jointing surfaces and apply two 6mm beads of DOW 791 silicone sealant either side of and around the slotted fixing holes to inside back/sole/front surfaces.

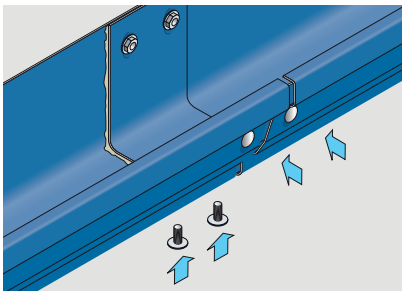

6. Slide in union joint and insert gutter bolts (heads outside). Secure joint with nuts and washers taking care not to over tighten or displace sealant from within the joint.

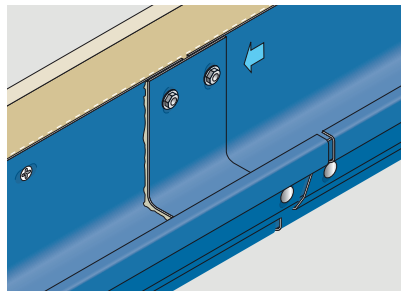

7. Slide in next gutter length and repeat process.

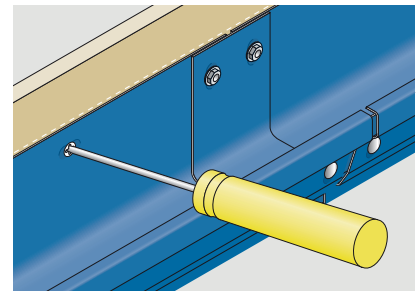

8. Tighten all fascia fixing screws and fit top straps if required otherwise screw back securely to the fascia using No12 x 38mm round head wood screws and washers provided.

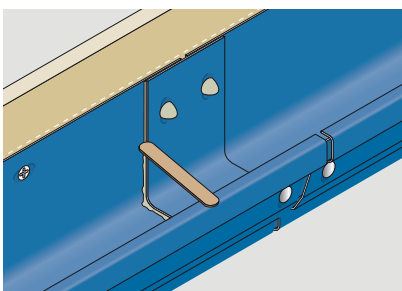

9. Tool off excess silicone and cone-off the exposed washers and nuts inside the gutter with a generous application of silicone sealant.

Installation - Flushjoint Rainwater Pipes

Flushjoint rainwater pipes consist of circular, square and rectangular pipes with factory fitted internal spigot joints between pipes and fittings. Pipes are bracket fixed and generally assembled from the eaves downward. Loose-fit pipe clips are used to secure Flushjoint pipes and can be positioned to allow pipe joints to be completely concealed.

Pipe Alignment

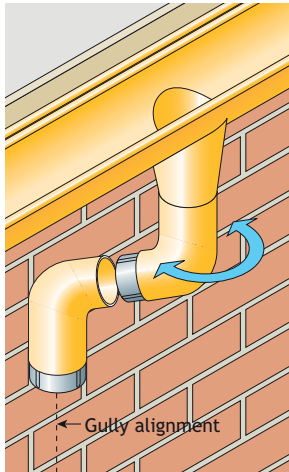

Check alignment of gutter outlet to gully. Where square or rectangular pipes are being installed and offsets are required, alignment between the gutter outlet and gully must be exact. Round pipe systems are more flexible to install as offsets can be adjusted and “swung” into alignment with the gully position.

Outlets and Offsets

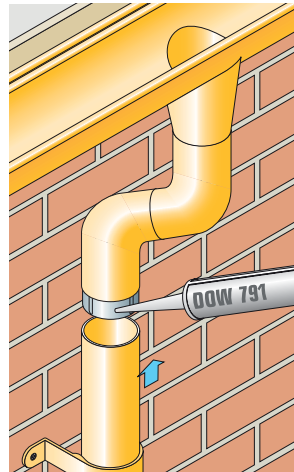

Commence installation from the gutter outlet by fitting and adjusting the two part offsets. Check vertical plumb line and assemble internal spigot joints using DOW 791 silicone sealant then fit first pipe clip.

Pipe Clips

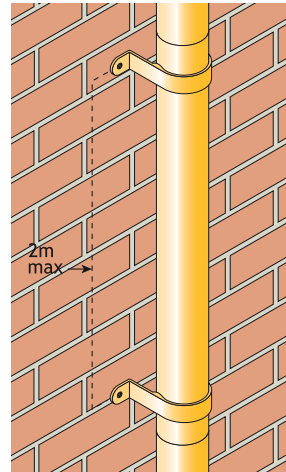

Pipe clips support and hold the rainwater pipe to the structure. All three types of pipe clip, Standard, Small Base and Extended Base can be used to conceal the pipe joints.

Fix to wall using No12 x 50mm screws provided. Allow two pipe clips per pipe length (maximum 2m centres) and fix with screws, placing a washer beneath the screw head.

Tools Required for Flushjoint

- String or plumb line
- Tape measure
- Drill
- File
- Masonry bit
- Wall fixing (e.g raw plug)
- Cleaning rags
- Marker pen
- Solvent cleaner
- Posi and plain screwdriver
- Paintbrush
- Hacksaw
- Masking tape
- Mastix gun
- Spirit level
- Protective gloves
- Adjustable spanner

General Installation Sequence

- Complete installation of gutters; alternatively, locate rainwater heads
- Locate
- Position offsets, bends and branches
- Fit pipes and brackets
- Fit plinth offsets
- Fit access doors and shoes

Sealant

For durable all weather seals and best results, Alumasc recommend the use of DOW 791 silicone sealant.

Rainwater Heads

Fix to masonry through external lugs or preformed holes in back.

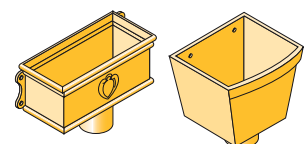

Pipes, Bends and Branches

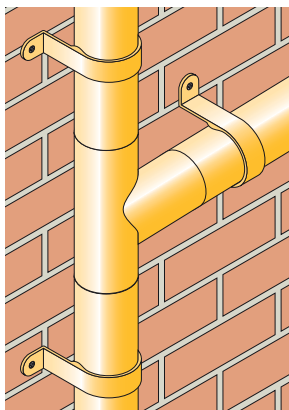

Continue to assemble the stack taking care not to scratch the pipe coating whilst sliding pipe clips into position.

Bends and branches are normally secured between pipe ends. Where additional fixing is required e.g a change of direction at a bend, use additional pipe clips.

Shoes

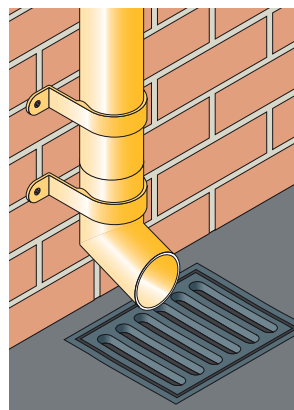

At ground level if the rainwater pipe does not connect directly to the gully, pipes can terminate with a shoe fitting for free discharge over the gully.

Access Pipes

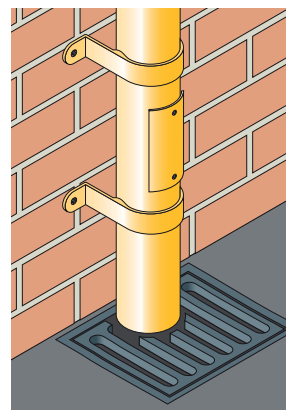

Where rainwater pipes directly connect to the gully it is recommended that an access pipe is fitted no more than 750mm above ground level.

Installation - Swaged Rainwater Pipes

Swaged rainwater pipes consist of circular pipes with swaged joints between pipes and fittings. Pipes are bracket fixed and generally assembled from the eaves downward. Loose-fit pipe clips are used to secure Swaged.

Pipe Alignment

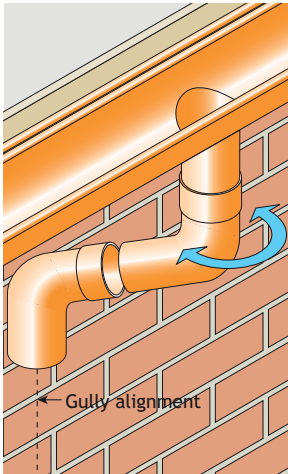

Check alignment of gutter outlet to gully.
Round pipe systems are more flexible to install as offsets can be adjusted and “swung” into alignment with the gully position.

Outlets and Offsets

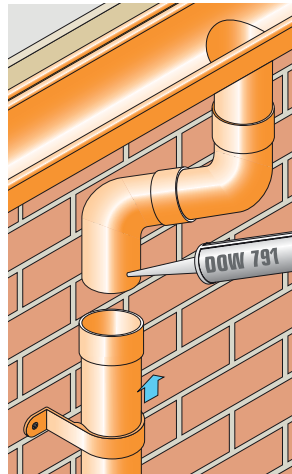

Commence installation from the gutter outlet by fitting and adjusting the two part offsets. Check vertical plumb line and assemble swaged joints using DOW 791 silicone sealant then fit first pipe clip.

Pipe Clips

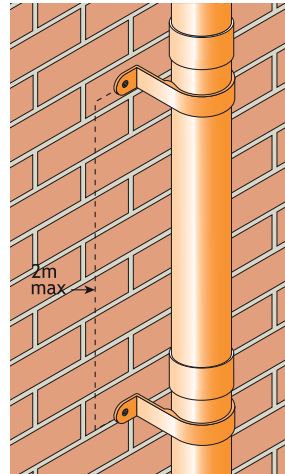

Pipe clips support and hold the rainwater pipe to the structure. All three types of pipe clip, Standard, Small Base and Extended Base can be used.
Fix to wall using No12 x 50mm screws provided. Allow two pipe clips per pipe length (maximum 2m centres) and fix with screws, placing a washer beneath the screw head.

Tools Required for Swaged

- String or plumb line
- Tape measure
- Drill
- File
- Masonry bit
- Wall fixing (e.g raw plug)
- Cleaning rags
- Marker pen
- Solvent cleaner
- Posi and plain screwdriver
- Paintbrush
- Hacksaw
- Masking tape
- Mastic gun
- Spirit level
- Protective gloves
- Adjustable spanner

Pipes, Bends and Branches

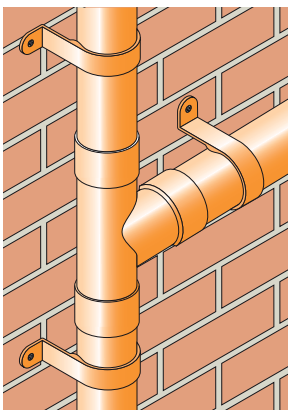

Continue to assemble the stack taking care not to scratch the pipe coating whilst sliding pipe clips into position.
Bends and branches are normally secured between pipe ends. Where additional fixing is required e.g a change of direction at a bend, use additional pipe clips.

Shoes

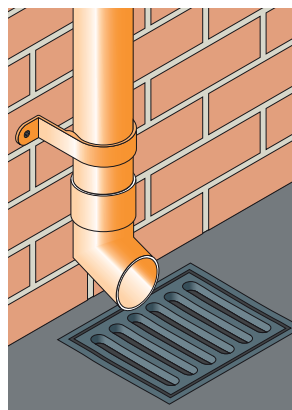

At ground level if the rainwater pipe does not connect directly to the gully, pipes can terminate with a shoe fitting for free discharge over the gully.

Access Pipes

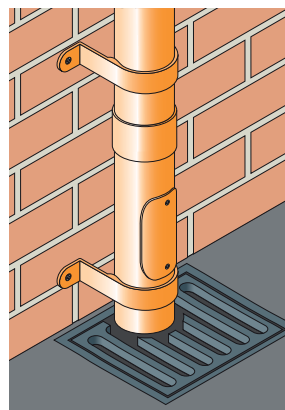

Where rainwater pipes directly connect to the gully it is recommended that an access pipe is fitted no more than 750mm above ground level.

General Installation Sequence

- Complete installation of gutters; alternatively, locate rainwater heads
- Locate
- Position offsets, bends and branches
- Fit pipes and brackets
- Fit plinth offsets
- Fit access doors and shoes

Sealant

For durable all weather seals and best results, Alumasc recommend the use of DOW 791 silicone sealant.

Rainwater Heads

Fix to masonry through external lugs or preformed holes in back.

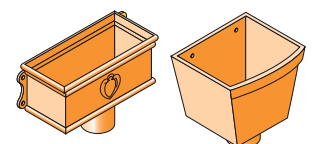

Installation - Guardian Rainwater Pipe

Guardian is a range of flush fitting architectural feature pipes in round, square and rectangular pipe section with factory fitted internal spigots and fully concealed bracketry. Pipe systems are assembled from ground upwards and are designed to be ungrippable, providing a high level of security.

Pipe Alignment

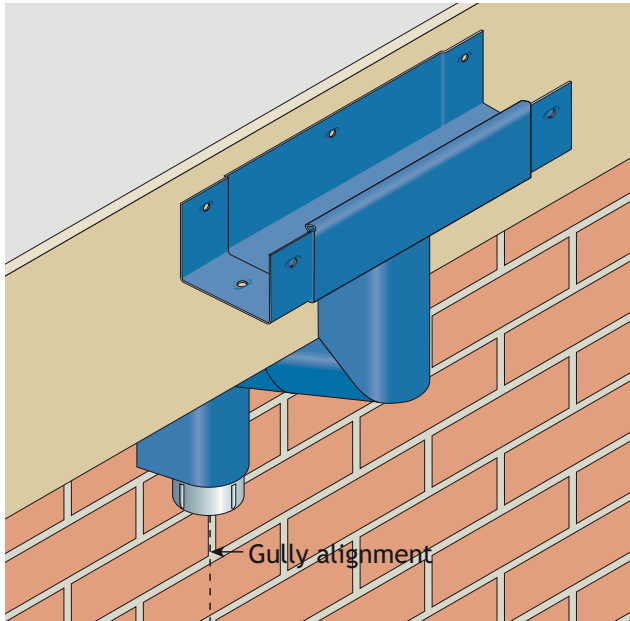

Guardian pipes are assembled from ground upwards. Use a plumb line to ensure correct alignment between gully at ground level and the gutter outlet.

Pipe Fixing Plates

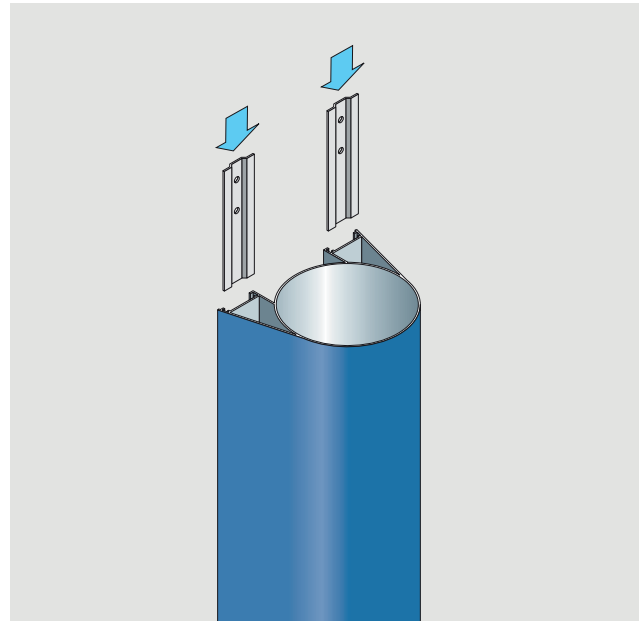

When joining pipe lengths tap two fixing plates per pipe connection into the pipe receiver rails using a block of wood to prevent damage. The fixing plates have "stops" to limit insertion. Fix to the wall using No12 x 38mm pan head screws.

Gully Connection

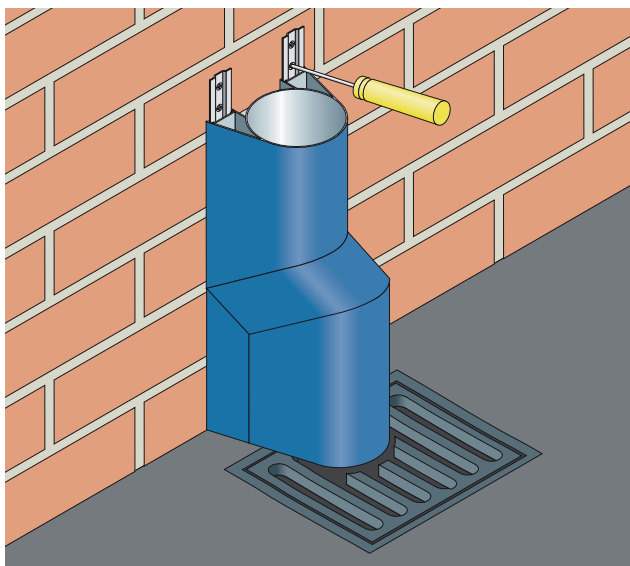

Commence installation by fitting fixing plates to the drain connector component and then fixing to the wall.

This component may be either a plain pipe section or include a rodding access.

Where the gully position is away from the wall, a shroud is available in order to eliminate gap. (Full site dimensions required).

Pipe Assembly

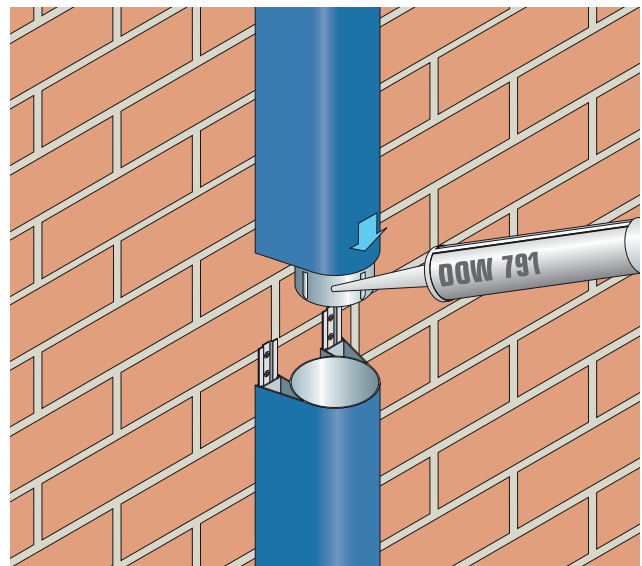

Pipe lengths are connected by sliding new pipe sections down over the fixing plates of the pipe below.

Seal spigot joints by applying DOW 791 silicone sealant to spigot and receiving pipe end.

Installation - Guardian Rainwater Pipe

Make Up Piece, Offsets and Gutter Connections

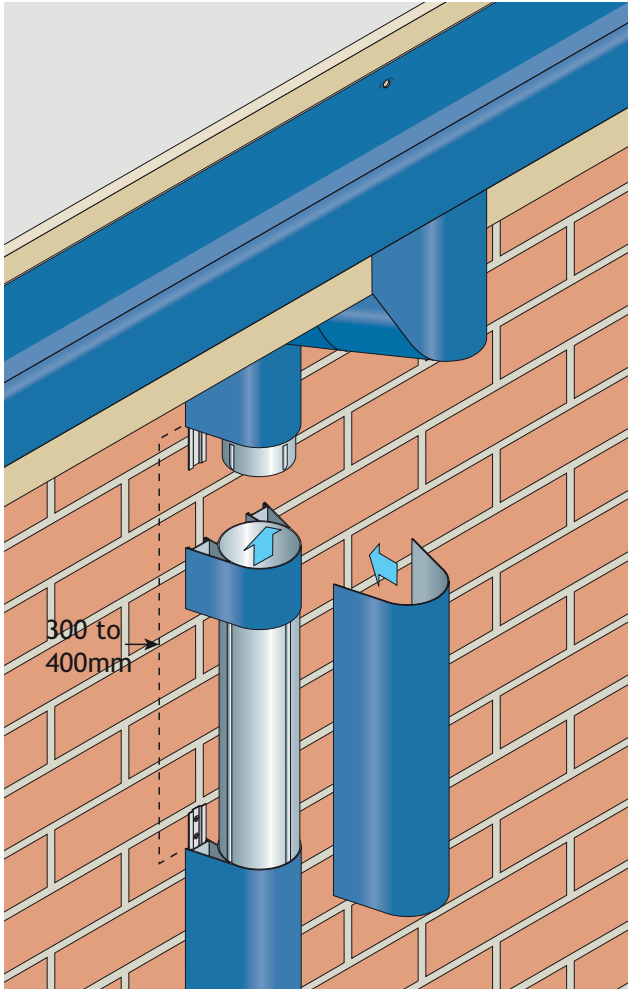

Build up and trim stack to within 300/400mm of underside of gutter and secure with fixing plates.

Insert telescopic section into stack below offset position, (if there is no offset use a straight make-up piece of equal length).

Fit the offset into the make up piece then lift up offset and make up piece to test the fit to the gutter spigot.

Cut a cover piece to fit gap created by the make up piece.

Apply DOW 791 silicone sealant to gutter spigot and adhere cover piece into position.

Tools Required for Guardian

- String or plumb line
- Tape measure
- Drill
- File
- Masonry bit
- Wall fixing (e.g raw plug)
- Cleaning rags
- Marker pen
- Solvent cleaner
- Posi and plain screwdriver
- Paintbrush
- Hacksaw
- Masking tape
- Mastic gun
- Spirit level
- Protective gloves
- Adjustable spanner

General Installation Sequence

- Complete installation of gutters;
- Locate
- Position offsets, bends and branches
- Fit pipes and brackets
- Fit plinth offsets
- Fit access doors and shoes

Sealant

For durable all weather seals and best results, Alumasc recommend the use of DOW 791 silicone sealant.

Alumasc Rainwater Systems Aluminium Range Supplementary Information

Essential background information to ensure that an appropriate and correct aluminium rainwater system is installed.

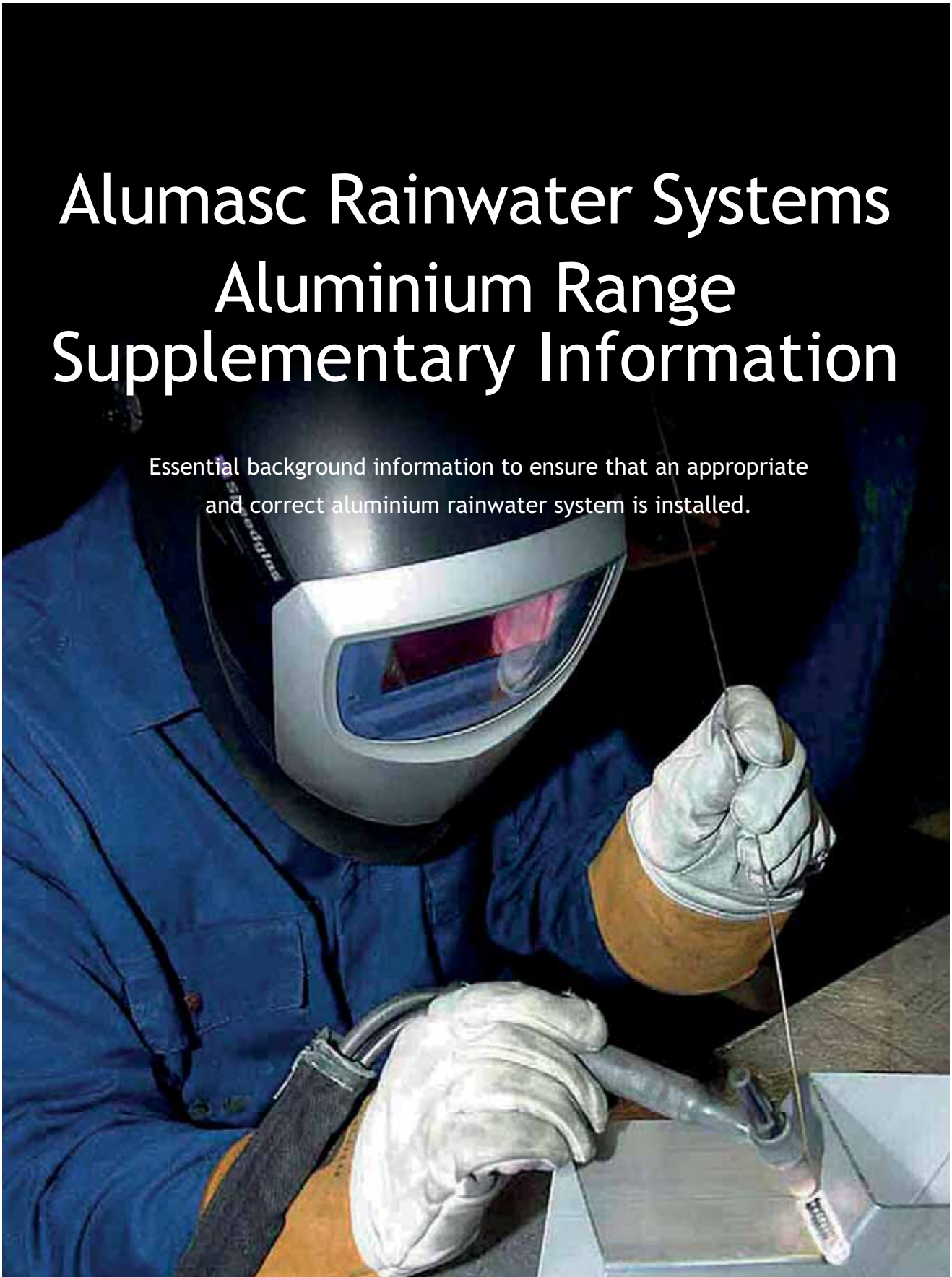

Non-Standard Items

Alumasc can tailor designs to meet individual project requirements, whether it is exact matching of rainwater products on restoration projects or stylish design solutions for new, contemporary buildings.



Alternative Gutter Profiles

Alumasc design and supply engineered rainwater systems and have the ability to develop patterns that are tailored to individual buildings' specific needs.

Whether the aim is to match an existing profile or simply to differentiate a building's appearance, Alumasc can offer bespoke gutter profiles to suit.

Radiused Gutter Sections

Where gutters are required to follow a particular roof radius, patterns can be engineered from detailed dimensions or existing gutter installations to yield a fully cast gutter that can be installed to suit the roof parameters. These are generally supplied in 1m lengths.

As an alternative to fully cast sections, Heritage and Aqualine profiles can be fabricated by cutting, mitring and welding to create a segmented radii gutter. GX profiles can be fabricated by mitring and seam-welding sections to create a segmented radii gutter. This often provides a cost effective solution for such architectural detailing.

Fabricated Gutter Sections

Standard gutter profiles can be fabricated into non-standard plan angles that can suit a host of different building geometries. Transition pieces for jointing mismatch gutter shapes, back outlets for drainage through parapet walls can all be expertly manufactured by Alumasc.

Rainwater Heads (Hoppers)

Ornate rainwater heads can be supplied to match existing design or one-off, personalised designs that will add enduring character and value to the building.

Rainwater heads can be manufactured from new patterns by the casting process. Alternatively, due to the flexibility afforded by the use of pressed aluminium sheet, fabricated items can be supplied to suit a whole range of requirements and applications.

Alumasc rainwater heads can also be enhanced by adding ornate enrichments or detailing, such as place names or initials onto the rainwater heads.

Bespoke Bracketry

Alumasc can design and manufacture a variety of bracketry solutions for gutters and pipes to create an integrated system. Such detailing can often be used to support fascia and soffit configurations.

Ornate holderbats and earbells can be detailed to provide a unique, distinguished appearance to a rainwater stack.

Where standard fitting dimensions do not suit the project's requirements, Alumasc can fabricate pipe systems to accommodate building design.

Ornate pipes can be supplied to match existing designs or one-off, personalised designs. Special enrichments can be added to create enduring character and value to the building.

Sundry Items



Touch Up Paint

RAL Code	Description	Size	Product Code
 RAL 1011m	Brown Beige	125ml	TUP/RAL1011M/125
 RAL 1013m	Pearl White	125ml	TUP/RAL1013M/125
 RAL 1021m	Cadmium Yellow	125ml	TUP/RAL1021M/125
 RAL 2002m	Vermilion	125ml	TUP/RAL2002M/125
 RAL 3003m	Ruby Red	125ml	TUP/RAL3003M/125
 RAL 3005m	Wine Red	125ml	TUP/RAL3005M/125
 RAL 5003m	Sapphire Blue	125ml	TUP/RAL5003M/125
 RAL 5010m	Flower Blue	125ml	TUP/RAL5010M/125
 RAL 6005m	Moss Green	125ml	TUP/RAL6005M/125
 RAL 6018m	Yellow Green	125ml	TUP/RAL6018M/125
 RAL 7005m	Mouse Grey	125ml	TUP/RAL7005M/125
 RAL 7006m	Beige Grey	125ml	TUP/RAL7006M/125
 RAL 7012m	Basalt Grey	125ml	TUP/RAL7012M/125
 RAL 7015m	Slate Grey	125ml	TUP/RAL7015M/125
 RAL 7016m	Anthracite Grey	125ml	TUP/RAL7016M/125
 RAL 7024m	Graphite Grey	125ml	TUP/RAL7024M/125
 RAL 7036m	Platinum Grey	125ml	TUP/RAL7036M/125
 RAL 7037m	Dusty Grey	125ml	TUP/RAL7037M/125
 RAL 7038m	Agate Grey	125ml	TUP/RAL7038M/125
 RAL 8017m	Chocolate Brown	125ml	TUP/RAL8017M/125
 RAL 8019m	Grey Brown	125ml	TUP/RAL8019M/125
 RAL 9006m	Metallic Silver	125ml	TUP/RAL9006M/125
 * RAL 9006g	Metallic Silver	125ml	TUP/RAL9006G/125
 RAL 9016m	White	125ml	TUP/RAL9016M/125
 RAL 9017m	Black	125ml	TUP/RAL9017M/125
	Black (Spray can)	400ml	TUP/BLACK/TXT

Note: The colours reproduced on this page are for general guidance only.

* 80% gloss

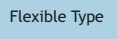
Lightning Link

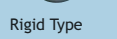
Type	Product Code
 Flexible Type Flexible Flat Braid Assembly	LL635007
 Rigid Type Assembly	LL632914
 Oxide Inhibitor Compound (50 joints per tube)	LL991972
 Rigid Type	Note: Provides an earth continuity bond intended for connection across joints on-site thereby providing electrical continuity throughout the entire metal gutter system. Extra pre-drilled fixing holes in gutter and fittings can be provided.

Backing Foam

Type	Product Code
 10m Roll x 6mm dia Backing Foam	BF991408

Solvent Cleaner

Type	Product Code
 Fast Drying Solvent Cleaner	SC991281



Silicone Sealant

Type	Colour	Size	Product Code
 Dow Corning 791	White	310ml Cartridge	SS991558
Dow Corning 791	Grey	310ml Cartridge	SS991559
Dow Corning 791	Bronze	310ml Cartridge	SS991560
Dow Corning 791	Black	310ml Cartridge	SS991561
Dow Corning 791	Limestone	310ml Cartridge	SS991562

Gutter Bolts (Nut, Bolt & Washer)

Type	Size	Notes	Product Code
 Aluminium Nut/Bolt/Washer	M6 x 12mm	For use with the GX Gutter Range	NBW 630308
Aluminium Nut/Bolt/Washer	M6 x 20mm	For use with the Heritage Gutter Range	NBW 630307

Woodscrew

Type	Size	Notes	Product Code
 Countersunk	No.12 x 1.5"	To fix rafter arms to GX Brackets	ZNBW969041
 Roundhead	No.12 x 1.5" With Washer	To fix Heritage Fascia Brackets or for 'direct fix' Gutter range	NBW 630362
Roundhead	No.12 x 2" With Washer	To fix pipe sockets with ears or pipe clips	NBW 630361

Rainwater System Design

Alumasc Technical Services is a fully experienced team of Rainwater specialists who use the latest CAD technology and calculation tools to provide an unrivalled support service to Architects, Designers and Contractors.

The Alumasc Rainwater Drainage Design Service

Alumasc Technical Services use dedicated design software in conjunction with the requirements of *BS EN 12056:2000: Gravity drainage systems inside buildings - Part 3* to calculate the most appropriate Alumasc rainwater system to suit project requirements.

The gutter flow software automatically checks the capacity of downpipes used and suggests the minimum size to which downpipes can be sized. Contact Alumasc for further information.

Sizing of Gutters and Downpipes

The level of rainfall a given roof drainage system should cope with is based on the position of the gutter, the potential use of the building and its projected lifespan. All true eaves gutters (external) are designed using a 1 year storm event. This is generally accepted because overflow from an external eaves gutter will fall clear of the building, which is not normally a problem. Any gutter which is classed internal, even if it is at the eaves, should be designed for an intensity based on the building life and a suitable factor of safety.

Step 1

Geographical Location and Rainfall Intensity Maps

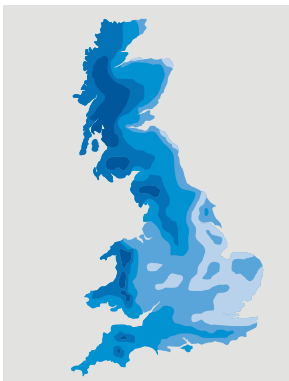

BS EN 12056-3: 2000 contains maps showing rainfall intensity in litres/second per m² for 1, 5, 50 and 500 year storms of 2 minute duration.

(All external gutters designed for 1 year event).

Step 2

Calculating Catchment Area

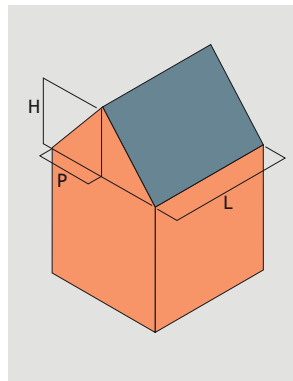

$$CA = (P+H/2) \times L$$

CA = Catchment area in square metres

P = Horizontal distance between eaves and ridge

H = Height of roof

L = Length of eaves

Calculation Criteria

Calculation of the most efficient drainage solution takes into consideration the following criteria:

- Catchment area
- Local rainfall intensity
- Building life and safety factor
- Size and flow rate of gutters
- Frequency and size of outlets and downpipes

This factor will vary from 1.5 for conventional buildings to 4.5 for very important structures. For most buildings a 60 year life and safety factor of 1.5 would be the most suitable (90 year protection life).

All the parameters of flow calculations cannot be captured using a single formula. The guide below provides a basic method for calculating flow requirements. For accurate project specific specification advice on rainwater flow calculations contact Alumasc Technical Services.

Step 3

Frequency and Positioning of Outlets/Downpipes

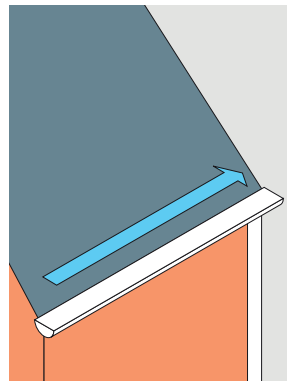

Calculate the number of outlets per run.

Step 4

Calculate Flow Requirements

Overall Rainfall

Catchment area (CA) x
Rainfall intensity (RI) =
Overall Rainfall (OR)

Flow Rate Per Outlet

Overall Rainfall (OR) ÷
Number of Outlets =
Flow Rate Per Outlet

Choose Gutter/Outlets
according to published
Flow Rate capacities.

Note:

Depending on building type, a safety factor should be allowed for the sizing of internal gutters. Contact Alumasc Technical Services for further information.



Technical Support

Alumasc's new Drainage Design Calculators are available as a download from the Alumasc Rainwater website.

www.alumascrainwater.co.uk

Gutter Flow Rates

All Flow Rates quoted on this page are shown in litres per second. Gutter capacities are based on BS EN 12056-3:2000, assuming a maximum distance of 50 x gutter depth, from high point to outlet. Longer gutters or gutters with corners exceeding 10° will have a reduced capacity. For further information contact Alumasc Technical Services.

Rainwater Gutter Flow Rates (l/s)

Gutter Range	Profile	Size (mm)	Pipe/Outlet Diameter (mm)			Pipe outlet size (mm)		
			63	75	100	75x75	100x75	100x100
Heritage	Half Round	100	1.14	1.24	-	1.24	1.24	-
		113	1.14	1.62	-	1.62	1.62	-
		125	1.24	2.08	-	2.08	2.08	-
	Beaded Half Round	113	1.62	1.62	-	1.62	1.62	-
		125	1.77	1.90	-	2.08	2.08	-
	Beaded Deep Run	113x75	1.77	1.90	-	2.10	3.06	-
	Victorian Ogee	100	1.32	1.32	-	1.32	1.32	-
		113	1.35	1.82	-	1.82	1.82	-
		125	1.35	2.12	-	2.10	2.34	-
	Moulded	100x75	1.40	1.64	-	2.10	2.44	-
		125x100	1.52	1.97	3.81	2.10	4.62	4.62
		150x100	2.42	2.84	3.81	2.10	4.65	5.12
Aqualine	Half Round	100x50	0.99	1.12	-	1.12	1.12	-
		120x60	0.99	1.71	-	1.86	1.86	-
		150x75	0.99	1.71	3.44	2.10	3.44	3.44
	Deep Run	110x85	0.99	1.71	2.88	2.10	2.88	2.88
	Modern	100x85	0.99	1.71	-	2.10	2.38	-
		150x120	0.99	1.71	3.81	2.10	3.63	5.41
	Moulded	140x100	0.99	1.71	-	2.10	3.52	-
		160x100	0.99	1.71	3.81	2.10	3.63	4.38
	Box	120x80	1.39	2.08	2.72	2.38	3.32	3.72
		140x100	1.55	2.32	4.21	2.66	4.02	5.32
		160x100	1.55	2.33	4.26	2.67	4.04	5.39
	GX	Joggle	100x75	1.32	1.95	-	2.28	-
125x100			1.52	2.31	4.14	2.64	3.99	5.23
150x100			1.52	2.31	4.14	2.64	3.99	5.23
150x150			1.89	2.83	5.16	3.24	4.89	6.59
200x150			1.89	2.83	5.16	3.24	4.89	6.59
Smooth		120x75	1.32	1.93	-	2.27	2.87	-
		140x100	1.52	2.28	3.99	2.61	3.95	5.04
		170x125	1.73	2.59	4.73	2.97	4.48	6.04
		175x150	1.90	2.84	5.20	3.26	4.92	6.63
		225x150	1.88	2.82	5.15	3.23	4.88	6.57
Moulded		113x75	0.99	1.71	-	2.10	-	-
		140x100	0.99	1.71	3.81	2.10	3.63	5.41
		160x100	0.99	1.71	3.81	2.10	3.63	5.41
		175x150	0.99	1.71	3.81	2.10	3.63	5.41
		200x150	0.99	1.71	3.81	2.10	3.63	5.41

Rainwater Pipe Flow Rates

Note: The capacity of a rainwater system is usually dependent upon the capacity of the gutter outlet or flat roof outlet rather than the rainwater pipe. Please refer to BS EN 12056-3:2000, Section 6, Table 8 for capacities of vertical rainwater pipes.

NBS Specification

A typical NBS Specification for Alumasc aluminium gutters and downpipes is provided below. A full range of NBS specifications are available via Alumasc's online NBS Specification Builder at www.alumascrainwater.co.uk. For project specific specification advice, contact Alumasc Technical Services.

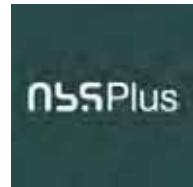

R10 Rainwater Drainage Systems

GENERAL

- Gravity Rainwater Drainage System.
- Rainwater outlets, gutters, pipework and accessories as per detail sections below.

SYSTEM PERFORMANCE

- Design Standard: To BS EN 12056-3:2000, clauses 3-7 and National Annexes.
- Collection and Distribution of Rainwater: Complete, and without leakage or noise nuisance.
- Design Parameters: Design rate of rainfall as per BS EN 12056-3:2000, National Annex NB.2 - Category 1

PRODUCTS (TYPICAL SPECIFICATION)

HERITAGE ALUMINIUM HALF ROUND GUTTER (100mm)

311 HERITAGE ALUMINIUM GUTTERS

Gutters and fittings to: BS 8530 (formerly BS 2997)
Manufacturer: Alumasc Exterior Building Products Ltd
White House Works, Bold Road, Sutton, St Helens, Merseyside WA9 4JG.
Tel: 01744 648400, Fax: 01744 648401, Email: info@alumasc-exteriors.co.uk

Reference: Heritage cast aluminium rainwater system
Profile: Half Round
Size: 100mm
Outlet Size: 75mm
Type/grade: Made from LM2 and LM6 grades of Aluminium alloy to BSEN1559:1997, BSEN 1676:1997 and BSEN 1706:1998
Finish: Polyester powder coated to BS EN 12206-1:2004
Colour: To be advised

Jointing: Gutter lengths or fittings are overlapped at the joint with a spigot and socket. Slots are provided for fixing using M6 mushroom head aluminium screws with nuts and washers. Seal evenly across the joints with Dow Corning 791.

Fixing: Fascia bracket fixed at 915mm centres and at each fitting using number 12x38mm round head twin thread screws and washers bright zinc plated.

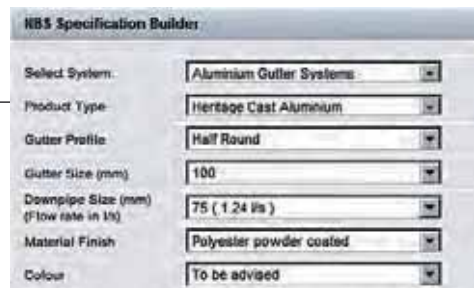

PRODUCTS (TYPICAL SPECIFICATION)

FLUSHJOINT ALUMINIUM DOWNPIPE (75mm diameter)

370 FLUSHJOINT ALUMINIUM PIPEWORK FOR EXTERNAL USE:

Pipes, fittings and accessories to: BS 2997
Manufacturer: As above

Reference: Flushjoint aluminium downpipe system
Size: 75mm diameter
Type/grade: 6063 TF alloy
Finish: Polyester powder coated to BS EN 12206-1:2004
Colour: To be advised

Fixing: Pipe clip fixed at maximum 2.0m centres. Plug and screw to wall with number 12 x 50mm round head twin thread screws and washers bright zinc plated to BS 1706:1960 Class ZN3. Seal internal spigot joints with Dow Corning 791 silicone sealant allowing for a 3-4 mm vertical thermal movement gap.

Accessories: Bends, Branches, Access Pipes, Offsets, Shoes, Rainwater Heads, Pipe Clips

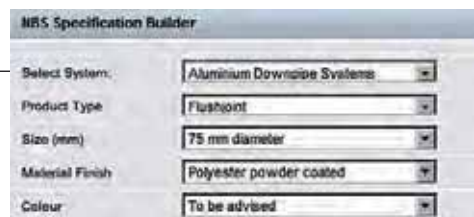

Create Alumasc Rainwater System NBS specifications by selecting the required product range, profile, size and finish by visiting:

www.alumascrainwater.co.uk

General Specification Advice

General specification clauses for aluminium rainwater systems are provided below.

For project specific specification advice, contact Alumasc Technical Services.

EXECUTION CLAUSES

600 PREPARATION, ENSURE:

- Below ground drainage is ready to receive rainwater or that the discharge can be dispersed by approved means to prevent damage or disfigurement of the building fabric.
- Any specified painting of surfaces which will be concealed or inaccessible is completed.

605 INSTALLATION GENERALLY:

- Install pipework/gutters to ensure the complete discharge of rainwater from the building without leaking.
- Obtain all components for each type of pipework/guttering from the same manufacturer unless specified otherwise.
- Provide access fittings and rodding eyes as necessary in convenient locations to permit adequate cleaning and testing of pipework.
- Avoid contact between dissimilar metals and other materials which would result in electrolytic corrosion.
- Do not bend plastics or galvanized steel pipes.
- Adequately protect pipework/gutters from damage and distortion during construction. Fit purpose made temporary caps to prevent ingress of debris. Fit all access covers, cleaning eyes and blanking plates as the work proceeds.
- Where not specified otherwise use plated, sherardized, galvanized or nonferrous fastenings, suitable for the purpose and background, and compatible with the material being fixed.

610 FIXING AND JOINTING GUTTERS:

- Fix securely at specified centres and at all joints in gutters, with additional brackets near angles and outlets.
- Provide for thermal and building movement when fixing and jointing, and ensure that clearances are not reduced as fixing proceeds.
- Seal as specified to make watertight.
- Spread jointing compound evenly over jointing face of socket.
- For gutters with bolted joints, tighten joints in the gutter sole before any other bolts. Fit suitable washers, and spacers to prevent overtightening, unless specified otherwise.
- Tighten fixing to squeeze out some compound.
- Remove surplus, squeezed out compound and neatly clean off.
- Ensure that roofing underlay is dressed into gutter.

615 SETTING OUT EAVES GUTTERS - TO FALLS

- Set out to a true line and even gradient to ensure no ponding or backfall. Position high points of gutters as close as practical to the roof and low points not more than 50 mm below the roof.
- Position outlets to align with connections to below ground drainage, unless shown otherwise on drawings.

630 RAINWATER OUTLETS, ENSURE THAT:

- Outlets are securely fixed before connecting pipework.
- Junctions between outlets and pipework can accommodate all movement in the structure and pipework.

435 FIXING PIPEWORK:

- Fix securely at specified centres plumb and/or true to line.
- Make changes in direction of pipe runs only where shown on drawings unless otherwise approved.
- Fix branches and low gradient sections with uniform and adequate falls to drain efficiently.
- Fix externally socketed pipes/fittings with sockets facing upstream.
- Provide additional supports as necessary to support junctions and changes in direction.
- Fix every length of pipe at or close below the socket collar or coupling.
- Provide a load bearing support for vertical pipes at not less than every storey level. Tighten fixings as the work proceeds so that every storey is self supporting and undue weight is not imposed on fixings at the base of the pipe.
- Isolate from structure where passing through walls or floors and sleeve pipes as specified in Section P31.
- Provide for thermal and building movement when fixing and jointing, and ensure that clearances are not reduced as fixing proceeds.
- Fix expansion joint pipe sockets rigidly to the building and elsewhere use fixings that allow the pipe to slide.

650 JOINTING PIPEWORK/GUTTERS:

- Joint using materials, fittings and techniques which will make effective and durable connections.
- Joint differing pipework/gutter systems with adaptors recommended by manufacturer(s).
- Cut ends of pipes to be clean and square with burrs and swarf removed. Chamfer pipe ends before inserting into ring seal sockets.
- Ensure that jointing or mating surfaces are clean, and where necessary lubricated, immediately before assembly.
- Form junctions using fittings intended for the purpose ensuring that jointing material does not project into bore of pipes, fittings and appliances.
- Remove surplus flux/solvent/cement/sealant from joints.

675 COATED PIPEWORK/GUTTERS:

- Make good to coatings after cutting and any other damage or recoat, as recommended by the manufacturer.

685 IDENTIFICATION OF INTERNAL RAINWATER PIPEWORK:

- To BS 1710 using self-adhesive bands or identification clips located at junctions, at both sides of each slab, bulkhead and wall penetration, and elsewhere as directed.

690 ELECTRICAL CONTINUITY:

- Use clips or suitable standard couplings supplied for the purpose by pipework manufacturer to ensure electrical continuity at all joints in metal pipes with flexible couplings and which are to be earth bonded.

700 ACCESS FOR TESTING AND MAINTENANCE:

- Install pipework and gutters with adequate clearance to permit testing, cleaning and maintenance.
- Position access fittings and rodding eyes so that they are not obstructed by other pipework, framing, etc.

COMPLETION CLAUSES

900 TESTING GENERALLY:

- Inform the Contractor Administrator sufficiently in advance to give him a reasonable opportunity to observe tests.
- Check that all sections of installation are free from obstruction and debris before testing.
- Provide clean water, assistance and apparatus for testing as required.
- Carry out tests as specified. After testing, locate and remedy all defects without delay and retest as instructed.
- Keep a record of all tests and provide a copy of each to the Contractor Administrator.

905 INTERNAL PIPEWORK TEST - ENGLAND, WALES AND NORTHERN IRELAND:

- Temporarily seal open ends of pipework with plugs.
- Connect a 'U' tube water gauge and air pump to the pipework via a plug.
- Pump air into pipework until gauge registers 38 mm.
- Allow a period for temperature stabilization, after which the pressure of 38 mm is to be maintained without loss for not less than 3 minutes.

906 INTERNAL PIPEWORK TEST- SCOTLAND

- Standard - To BSEN12056-3:2000, National Annex NG

910 GUTTER TEST:

- Block all outlets, fill gutters to overflow level and after 5 minutes closely inspect for leakage.

915 MAINTENANCE INSTRUCTIONS

- At completion, submit printed instructions recommending procedures for maintenance of the rainwater installation including full details of the recommended inspection, cleaning and repair procedures.

920 IMMEDIATELY BEFORE HANDOVER:

- Remove construction rubbish and debris from all roofs and gutters. Where possible, sweep and remove fine dust which may enter rainwater systems. Do not sweep or flush dust or debris into the rainwater system.
- Remove swarf, debris and temporary caps from the entire rainwater installation.
- Ensure that all access covers, rodding eyes, outlet gratings, etc. are secured complete with all fixings.

Skyline System - Introduction

The interface between walls and roof at the building eaves is one of the most crucial facets of design - both functionally and aesthetically. The sharpness and vibrancy of Alumasc's Skyline range of Fascias, Soffits and Copings provides dramatic engineered solutions over a wide range of buildings for both public and commercial sectors.

The Skyline Range

Skyline is a stylish and functional aluminium fascia, soffit and coping range offering solutions for use at roofing and gutter interfaces. Standard and fully bespoke designs from the Skyline range are available in high quality, in-house powder coated aluminium.

Skyline fascia and soffit components are designed to be used in conjunction with Alumasc's aluminium rainwater systems, in particular the GX range of folded aluminium gutters, providing a complete eaves and roof drainage solution.

Alumasc Technical Services can assist in the design of a fixing and support framework to suit individual project requirements. A design and fabrication service is also available for bespoke fascia profiles to suit special project requirements.

Skyline is not a rigid set of standard components, but a product rationale, developed to exploit the potential of Alumasc's wide ranging production capability in pressed and folded aluminium.



Skyline Fascias and Soffits

Skyline's range of four generic fascia profiles in aluminium, complemented by interlocking soffit planks, provides a wide choice of building eaves solutions.

Fascia profiles combine with soffit panels to create a range of fascia configurations which may be projected direct from the elevation or they may be combined with Alumasc soffit planks to produce varying eaves overhangs. (See page 122)

Skyline Coping System

Skyline Copings provide an economical and easily installed capping to upstanding parapets, in conjunction with flat or pitched roofs. The strap fixing method avoids penetration of the capping, whilst allowing ventilation over the top of the wall. Skyline Copings are maintenance free, available in a wide range of colours and are equally suited to retrofit and new build projects. (See page 123)

Skyline Anti-Climb

Skyline Anti-Climb is designed with security in mind, preventing unauthorised access to the building roofscape. Skyline Anti-Climb barriers comprise support brackets and preformed curved barrier sections. They can be fitted in front of virtually any gutter profile, resulting in a bold architectural feature.



Skyline Fascias and Soffits

Alumasc's Skyline Fascia and Soffit configurations offer top of the range roof edge details to suit all designs and budgets.

Standard Skyline Profiles

Skyline Fascias and Soffits are manufactured from high quality, polyester powder coated aluminium and are available in four bold generic shapes with bespoke designs available to order. Skyline can be fully integrated with Alumasc's aluminium rainwater systems.

Skyline Designer

Skyline Designer is not a defined product range, but a collection of ideas which provide the architect with an opportunity to create highly distinctive fascias, soffit panels and cassettes that can be detailed and fabricated in a multitude of shapes and sizes to suit project requirements. If it can be made, we can make it.

Alumasc Technical Services can offer advice from the first pencil sketches right up to site installation. Once the architectural details are agreed, full working drawings are produced with client approval requested prior to fabrication.

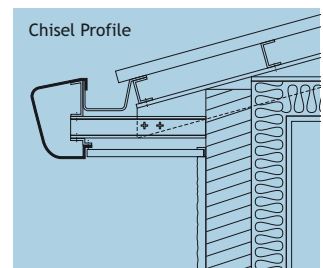
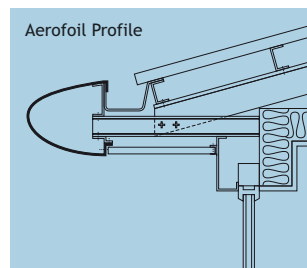
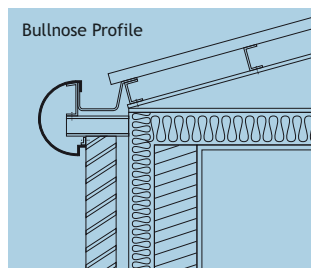
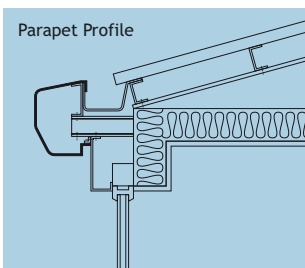

Skyline Coping System

The Skyline Coping system provides an economical and easily installed capping to upstand parapets, in conjunction with flat or pitched roofs. The strap fixing method avoids penetration of the capping, whilst allowing ventilation over the top of the wall. Skyline Copings are equally suited to retrofit and new build projects.

Applications

- Provides a totally weatherproof covering to upstand parapets as fixing method does not penetrate the Skyline Coping
- Suitable for new buildings and retrofit

Performance

- Attractive, clean lines are maintained as fixings are not visible on the surface of the Skyline Coping
- The fixing strap profile allows ventilation over the top of the wall whilst remaining weatherproof
- Material thickness and fixing mechanism gives excellent rigidity
- Lightweight, durable and non-corrodible
- Coefficient of linear thermal expansion is $23 \times 10^{-6} \text{mm/m}^\circ\text{C}$
- A gap of 3-4mm should be left between Skyline Coping sections to accommodate thermal expansion
- Life expectancy of aluminium: 40 years (rural/suburban areas); up to 25 years (industrial/marine areas)
- Aluminium is 100% recyclable

Components and Manufacture

- UK manufactured
- Skyline Coping are fabricated from 2mm or 3mm thick aluminium alloy sheet, depending on width
- Fixing straps are pressed 3mm aluminium with extruded EPDM seals bonded to the top surface
- All fabricated fittings (90° corners, irregular corners, stop ends, closed ends, upstands, 90° tee junctions) are mitred, welded and have a smooth finish on the front face
- A waterproof membrane will be required beneath the Skyline Coping to provide an effective seal

Colours & Finishes

- In-house polyester powder coating facility with 16 BBA approved standard colours
- Additional BS or RAL colours available to special order; also available in plain mill finish for on-site painting

Installation & Fixing

- Simple and quick to install
- In most cases fixing can be carried out from the roof so no external access is required making it particularly suitable for renovation work
- Minimal maintenance requirements

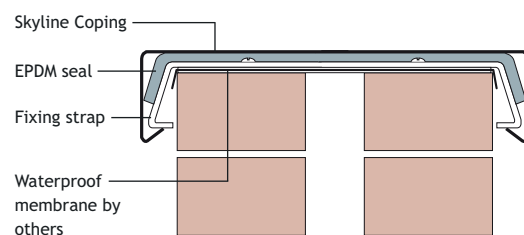

Alumasc Rainwater Systems The Cast Iron Standard Range

This rainwater standard range features the
Apex Heritage System,
available with four gutter and three downpipe profiles,
complete with fittings and accessories ranging from
extended bracketry to hopper heads.

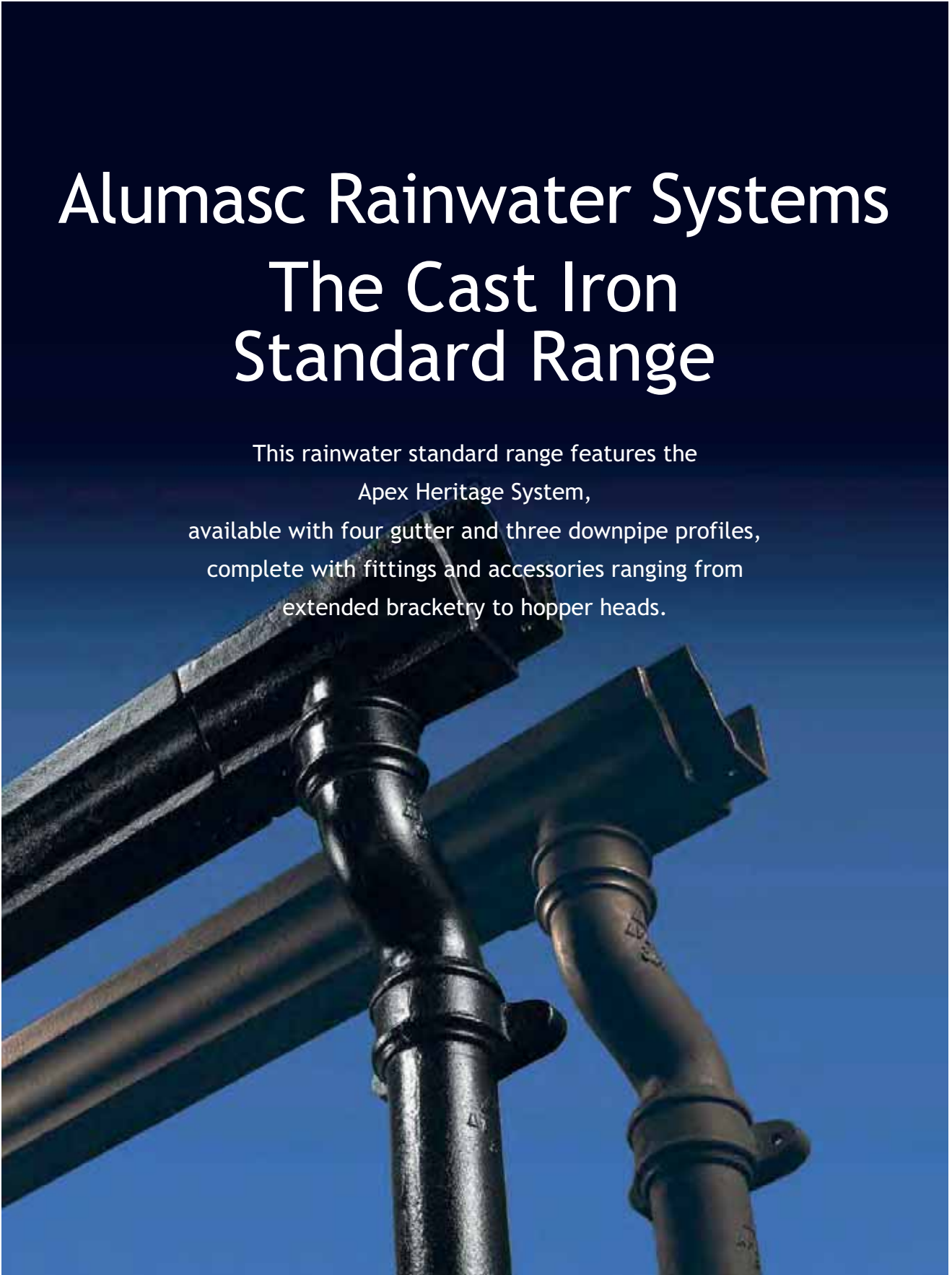

Standard Cast Iron Rainwater Range - Introduction



Apex Heritage Cast Iron is a complete range of traditional sand cast gutters, downpipes and fittings combined with a made to order capability to suit any new, refurbished or restored building projects.



Apex Heritage Rainwater Systems - Standard Range Product Summary



Apex Heritage - Half Round Gutter



Apex Heritage - Beaded Half Round Gutter



Apex Heritage - Circular Pipe



Apex Heritage - Victorian Ogee Gutter

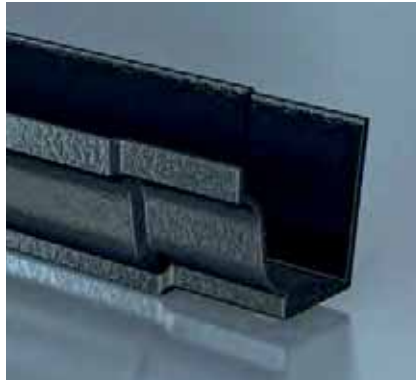

Apex Heritage - Moulded Gutter



Apex Heritage - Square Pipe



Apex Heritage - Rectangular Pipe

Apex Heritage Rainwater Systems - Standard Range Product Summary



Apex Heritage is a comprehensive range of traditional gutter profiles, round, square and rectangular pipes and all associated fittings and accessories. Designed to provide all the essential architectural features appropriate to traditionally designed buildings, the Apex Heritage range is also fully in tune with modern fast track building contracts.

Applications

- Suited to traditional craft based contracts
- Closely replicates historic styles
- For both flush and projecting eaves applications

Features & Performance

- 4 gutter profiles and 3 downpipe profiles available in a choice of sizes
- Downpipes available in 0.9m (3ft) and 1.83m (6ft) lengths
- Extremely strong, durable and vandal resistant
- Dimensionally accurate and stable
- Life expectancy in excess of 40 years
- Cast iron is 100% recyclable

Colours & Finishes

- A high quality two-pack epoxy primer and top coat painted finish
- Now available in a range of 8 standard RAL colour options with other RAL colours available to special order
- 'Factory Certified' Paint finish
- Also available in a factory primed one coat of protective oxide primer



Factory-applied oxide primer

Manufacture

- Authentic sand castings combining traditional manufacture with modern quality control standards
- A comprehensive standard range complemented with master patterns for a wide range of gutter profiles, downpipes and accessories, which can be manufactured to order.
- Complies with BS 460:2002 Cast Iron Rainwater Goods

Installation & Fixing

- Gutters are wet sealed with bolted joints, with a range of fixing options
- For Half Round gutters the Hydrostrip EDPM rubber seal is recommend for faster and cleaner solution to gutter jointing
- Gutters should be supported at 900mm centres either on brackets or for ogee, moulded and box types, by direct screw fixing through the back of the gutter
- Downpipes should be fixed back to the wall at 1.83 (6ft) centres through eared sockets or via separate earbelt and holderbats
- Minimal maintenance requirements



Pre-finished painted black

Gutter Profiles & Sizes



Half Round
100mm (4")
113mm (4.5")
125mm (5")
150mm (6")



Beaded Half Round
113mm (4.5)
125mm (5")



Victorian Ogee
113mm (4.5")
125mm (5")

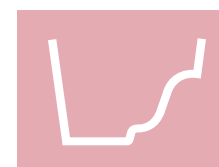

Moulded
100 x 75mm (4 x 3")
125 x 100mm (5 x 4")
150 x 100mm (6 x 4")

Pipe Profiles & Sizes

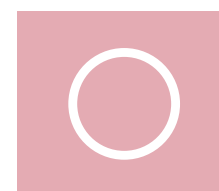

Circular Pipe
63mm (2.5")
75mm (3")
100mm (4")
Length
1.83m (6')
0.9m (3')



Square Pipe
75 x 75mm (3 x 3")
100 x 100mm (4 x 4")
Length
1.83m (6')
0.9m (3')

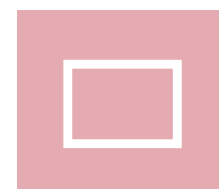

Rectangular Pipe
100 x 75mm (4 x 3")
125 x 100mm (5 x 4")
150 x 100 mm (6 x 4")
Length
1.83m (6')
0.9m (3')

Apex Heritage - Half Round Gutters and Fittings



Apex Heritage Half Round socketed cast iron gutters are available in 4 sizes. A traditional profile with the unmistakable character and appearance of sand cast iron. There is a range of fittings and fixings as illustrated.

Note: All dimensions shown are in mm unless shown otherwise.
Gutter sizes shown are nominal.

Gutters

Gutter Size	Gutter Length	A	B	C	T	Weight (kg)	Product Code
100 (4")	1830mm	102	51	44	4	8.0	HG40/6FT
113 (4.5")	1830mm	114	57	44	4	10.5	HG45/6FT
125 (5")	1830mm	127	63	44	4	11.5	HG50/6FT
150 (6")	1830mm	150	75	44	4	13.5	HG60/6FT

Note: T = Thickness (nominal +/- 1mm)

Union Clips

Gutter Size	A	B	Product Code
100	98	44	HG40/UC
113	98	44	HG45/UC
125	98	44	HG50/UC
150	95	44	HG60/UC

Stop Ends

Gutter Size	Type	A	Product Code	
External Gutter	100	External	51	HG40/SE/E
	113	"	51	HG45/SE/E
	125	"	51	HG50/SE/E
	150	"	51	HG60/SE/E
Internal Socket	100	Internal	45	HG40/SE/I
	113	"	45	HG45/SE/I
	125	"	45	HG50/SE/I
	150	"	45	HG60/SE/I

Fascia Brackets

Gutter Size	A	B	C	D	Product Code
100	127	65	38	35	HG40/FB/CI
113	140	70	38	40	HG45/FB/CI
125	155	85	38	45	HG50/FB/CI
150	190	120	30	90	HG60/FB/CI

Note: Products are available with an oxide primed coating or with a certified factory painted finish.
Product Codes in the tables refer to primed products. For Painted products add the suffix /PA to the Product Code reference.

Apex Heritage - Half Round Gutters and Fittings

Drop End Outlet - with Socket

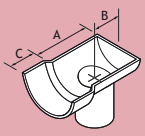
	Gutter Size	Pipe Size	A	B	C	Product Code
	100	63 dia	125	64	44	HG40/DE/25/E
	113	63 dia	125	64	44	HG45/DE/25/E
	125	63 dia	125	64	44	HG50/DE/25/E
	100	76 dia	125	64	44	HG40/DE/30/E
	113	76 dia	125	64	44	HG45/DE/30/E
	125	76 dia	125	64	44	HG50/DE/30/E

Drop End Outlet - with Spigot

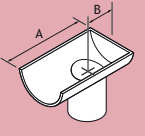
	Gutter Size	Pipe Size	A	B	Product Code
	100	63 dia	172	64	HG40/DE/25/I
	113	63 dia	172	64	HG45/DE/25/I
	125	63 dia	172	64	HG50/DE/25/I
	100	76 dia	172	64	HG40/DE/30/I
	113	76 dia	172	64	HG45/DE/30/I
	125	76 dia	172	64	HG50/DE/30/I

Running Outlet - with Double Spigot Socket

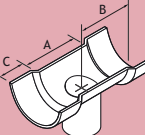
	Gutter Size	Pipe Size	A	B	C	Product Code
	100	63 dia	156	121	44	HG40/RO/25
	113	63 dia	156	121	44	HG45/RO/25
	125	63 dia	156	121	44	HG50/RO/25
	100	75 dia	156	121	44	HG40/RO/30
	113	75 dia	156	121	44	HG45/RO/30
	125	75 dia	156	121	44	HG50/RO/30
	150	75 dia	156	121	44	HG60/RO/30
	125	100 dia	156	121	44	HG50/RO/40
	150	100 dia	156	121	44	HG60/RO/40

90° Angles Combined

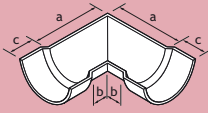
	Gutter Size	Type	A	B	C	Product Code
	100	Internal/External	190	79	44	HG40/A/90
	113	Internal/External	200	79	44	HG45/A/90
	125	Internal/External	209	79	44	HG50/A/90
	150	Internal/External	235	79	44	HG60/A/90

120° Angles Combined

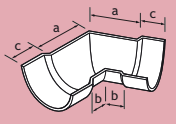
	Gutter Size	Type	A	B	C	Product Code
	100	Internal/External	124	79	44	HG40/A/120
	113	Internal/External	124	76	44	HG45/A/120
	125	Internal/External	136	79	44	HG50/A/120
	150	Internal/External	140	75	44	HG60/A/120

135° Angles Combined

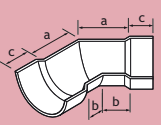
	Gutter Size	Type	A	B	C	Product Code
	100	Internal/External	124	79	44	HG40/A/135
	113	Internal/External	124	76	44	HG45/A/135
	125	Internal/External	137	79	44	HG50/A/135
	150	Internal/External	128	75	44	HG60/A/135

Note: Products are available with an oxide primed coating or with a certified factory painted finish.
Product Codes in the tables refer to primed products. For Painted products add the suffix /PA to the Product Code reference.

Apex Heritage - Beaded Half Round Gutters and Fittings



Apex Heritage Beaded Half Round socketed cast iron gutters, in 2 sizes, incorporate a pronounced feature bead on both lips. This adds character and definition to the gutter edge in a true sand cast product. Fittings and fixings are also available as illustrated.

Note: All dimensions shown are in mm unless shown otherwise.
Gutter sizes shown are nominal.

Gutters

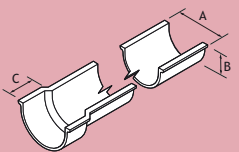
	Gutter Size	Gutter Length	A	B	C	T	Weight (kg)	Product Code
	113 (4.5")	1830mm	114	57	44	4	11	BG45/6FT
125 (5")	1830mm	127	63	44	4	12.5	BG50/6FT	
Note: T = Thickness (nominal +/- 1mm)								

Union Clips

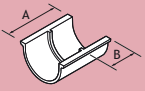
	Gutter Size	A	B	Product Code
	113	78	44	BG45/UC
125	78	44	BG50/UC	

Stop Ends

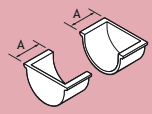
	Gutter Size	Type	A	Product Code
	External Gutter Internal Socket	113	External	51
125		"	51	BG50/SE/E
113		Internal	45	BG45/SE/I
125		"	45	BG50/SE/I

Fascia Brackets

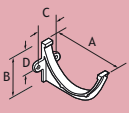
	Gutter Size	A	B	C	D	Product Code
	113	155	97	25	75	BG45/FB/CI
125	160	115	32	87	BG50/FB/CI	

Note: Products are available with an oxide primed coating or with a certified factory painted finish.
Product Codes in the tables refer to primed products. For Painted products add the suffix /PA to the Product Code reference.

Apex Heritage - Beaded Half Round Gutters and Fittings

Running Outlet - with Double Spigot Socket

Gutter Size	Pipe Size	A	B	C	Product Code
113	63 dia	156	121	44	BG45/RO/25
125	63 dia	156	121	44	BG50/RO/25
113	75 dia	156	121	44	BG45/RO/30
125	75 dia	156	121	44	BG50/RO/30
125	100 dia	156	121	44	BG50/RO/40

90° Angles Combined

Gutter Size	Type	A	B	C	Product Code
113	Internal/External	206	70	44	BG45/A/90
125	Internal/External	116	70	44	BG50/A/90

120° Angles Combined

Gutter Size	Type	A	B	C	Product Code
113	Internal/External	130	76	44	BG45/A/120
125	Internal/External	140	79	44	BG50/A/120

135° Angles Combined

Gutter Size	Type	A	B	C	Product Code
113	Internal/External	130	76	44	BG45/A/135
125	Internal/External	140	79	44	BG50/A/135

Note: Products are available with an oxide primed coating or with a certified factory painted finish.
Product Codes in the tables refer to primed products. For Painted products add the suffix /PA to the Product Code reference.

Apex Heritage - Victorian Ogee Gutters and Fittings



Apex Heritage Ogee cast iron socketed gutters are available in 2 sizes.

An elegant Victorian ogee profile combined with the robust visual quality of sand cast iron. There is a range of fittings and fixings as illustrated.

Note: All dimensions shown are in mm unless shown otherwise.
Gutter sizes shown are nominal.
Victorian Ogee is a left hand socket system.

Gutters

Gutter Size	Gutter Length	A	B	C	T	Weight (kg)	Product Code
113 (4.5")	1830mm	114	54	44	4	11.5	OG45/6FT
125 (5")	1830mm	127	63	44	4	12.5	OG50/6FT

Note: T = Thickness (nominal +/- 1mm)

Union Clips

Gutter Size	A	B	Product Code
113	78	44	OG45/UC
125	78	44	BG50/UC

Stop Ends

Gutter Size	Type	A	Product Code
Right Hand External	External Right Hand	54	OG45/SE/RE
	"	54	OG50/SE/RE
Left Hand Internal	External Left Hand	54	OG45/SE/LE
	"	54	OG50/SE/LE
Left Hand Internal	Internal Left Hand	44	OG45/SE/LI
	"	44	OG50/SE/LI

Fascia Brackets

Gutter Size	A	B	C	D	Product Code
113	137	85	38	38	OG45/FB/CI
125	150	92	38	38	OG50/FB/CI

Note: Products are available with an oxide primed coating or with a certified factory painted finish.
Product Codes in the tables refer to primed products. For Painted products add the suffix /PA to the Product Code reference.

Apex Heritage - Victorian Ogee Gutters and Fittings

Running Outlet - with Single Socket

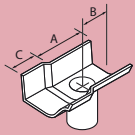
	Gutter Size	Pipe Size	A	B	C	Product Code
	113	63 dia	200	121	44	OG45/RO/25
	125	63 dia	200	121	44	OG50/RO/25
	113	75 dia	200	121	44	OG45/RO/30
	125	75 dia	200	121	44	OG50/RO/30
	125	100 dia	200	121	44	OG50/RO/40

90° Angles

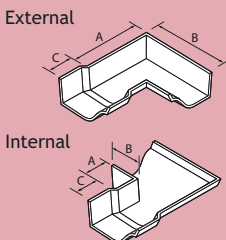
	Gutter Size	Type	A	B	C	Product Code
	113	External	28	76	44	OG45/EA/90
	125	"	28	76	44	OG50/EA/90
	113	Internal	156	206	44	OG45/IA/90
	125	"	159	216	44	OG50/IA/90

120° Angles

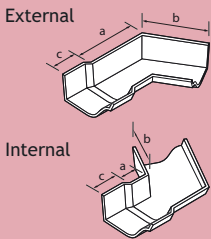
	Gutter Size	Type	A	B	C	Product Code
	113	External	28	76	44	OG45/EA/120
	125	"	28	76	44	OG50/EA/120
	113	Internal	98	149	44	OG45/IA/120
	125	"	105	159	44	OG50/IA/120

135° Angles

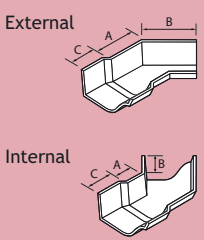
	Gutter Size	Type	A	B	C	Product Code
	113	External	28	76	44	OG45/EA/135
	125	"	28	76	44	OG50/EA/135
	113	Internal	86	130	44	OG45/IA/135
	125	"	86	130	44	OG50/IA/135

Note: Products are available with an oxide primed coating or with a certified factory painted finish.
Product Codes in the tables refer to primed products. For Painted products add the suffix /PA to the Product Code reference.

Apex Heritage - Moulded Gutters and Fittings



Available in 3 sizes, Apex Heritage Moulded socketed cast iron gutters have a sharply featured decorative profile. A range of fittings and fixings as illustrated completes the system.

Note: All dimensions shown are in mm unless shown otherwise.
Gutter sizes shown are nominal.

Gutters

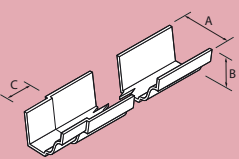
	Gutter Size	Gutter Length	A	B	C	T	Weight (kg)	Product Code
	100 x 75	1830mm	108	76	50	4	11	MG43/6FT
	125 x 100	1830mm	140	102	50	4	18	MG54/6FT
	150 x 100	1830mm	162	102	50	4	19	MG64/6FT

Note: T = Thickness (nominal +/- 1mm)

Union Clips

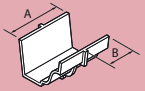
	Gutter Size	A	B	Product Code
	100 x 75	78	44	MG43/UC
	125 x 100	78	44	MG54/UC
	150 x 100	78	44	MG64/UC

Stop Ends

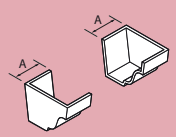
	Gutter Size	Type	A	Product Code
	100 x 75	External Right Hand	54	MG43/SE/RE
	125 x 100	"	54	MG54/SE/RE
	150 x 100	"	54	MG64/SE/RE
	100 x 75	Internal Left Hand	51	MG43/SE/LI
	125 x 100	"	51	MG54/SE/LI
	150 x 100	"	51	MG64/SE/LI
	100 x 75	Internal Right Hand	51	MG43/SE/RI
	125 x 100	"	51	MG54/SE/RI
	150 x 100	"	51	MG64/SE/RI

Fascia Brackets

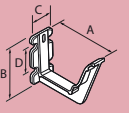
	Gutter Size	A	B	C	D	Product Code
	100 x 75	135	125	30	85	MG43/FB/CI
	125 x 100	170	150	35	110	MG54/FB/CI
	150 x 100	190	150	35	118	MG64/FB/CI

Note: Products are available with an oxide primed coating or with a certified factory painted finish.
Product Codes in the tables refer to primed products. For Painted products add the suffix /PA to the Product Code reference.

Apex Heritage - Moulded Gutters and Fittings

Running Outlet - Single Spigot/Socket - Round Pipe

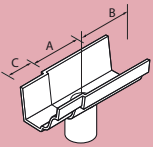
	Gutter Size	Round Pipe Size	A	B	C	Product Code
	100 x 75	63 dia	251	124	50	MG43/RO/25
	125 x 100	63 dia	251	124	50	MG54/RO/25
	150 x 100	63 dia	251	124	50	MG64/RO/25
	100 x 75	75 dia	251	124	50	MG43/RO/30
	125 x 100	75 dia	251	124	50	MG54/RO/30
	150 x 100	75 dia	251	124	50	MG64/RO/30
	100 x 75	100 dia	251	124	50	MG43/RO/40
	125 x 100	100 dia	251	124	50	MG54/RO/40
150 x 100	100 dia	251	124	50	MG64/RO/40	

Running Outlet with Single Spigot/Socket - Square Pipe

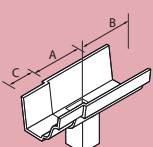
	Gutter Size	Square Pipe Size	A	B	C	Product Code
	100 x 75	75 x 75	251	124	50	MG43/RO/33
	125 x 100	75 x 75	251	124	50	MG54/RO/33
	150 x 100	75 x 75	251	124	50	MG64/RO/33
	100 x 75	100 x 75	251	124	50	MG43/RO/43
	125 x 100	100 x 75	251	124	50	MG54/RO/43
	150 x 100	100 x 75	251	124	50	MG64/RO/43
	150 x 100	100 x 100	251	124	50	MG64/RO/44
150 x 100	125 x 100	251	124	50	MG64/RO/54	

90° Angles

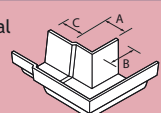
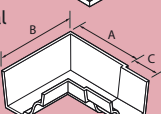
	Gutter Size	Type	A	B	C	Product Code
			A	B	C	
External	100 x 75	External	28	79	50	MG43/EA/90
	125 x 100	"	28	79	50	MG54/EA/90
	150 x 100	"	25	70	50	MG64/EA/90
	100 x 75	Internal	137	187	50	MG43/IA/90
	125 x 100	"	168	216	50	MG54/IA/90
	150 x 100	"	181	229	50	MG64/IA/90

120° Angles

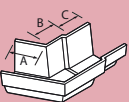
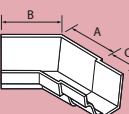
	Gutter Size	Type	A	B	C	Product Code
			A	B	C	
External	100 x 75	External	35	79	50	MG43/EA/120
	125 x 100	"	35	79	50	MG54/EA/120
	150 x 100	"	35	79	50	MG64/EA/120
	100 x 75	Internal	60	111	50	MG43/IA/120
	125 x 100	"	111	156	50	MG54/IA/120
	150 x 100	"	50	168	50	MG64/IA/120

135° Angles

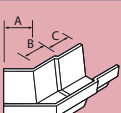
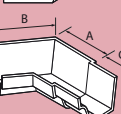
	Gutter Size	Type	A	B	C	Product Code
			A	B	C	
External	100 x 75	External	28	79	50	MG43/EA/135
	125 x 100	"	35	79	50	MG54/EA/135
	150 x 100	"	41	89	50	MG64/EA/135
	100 x 75	Internal	73	124	50	MG43/IA/135
	125 x 100	"	89	137	50	MG54/IA/135
	150 x 100	"	98	140	50	MG64/IA/135

Note: Products are available with an oxide primed coating or with a certified factory painted finish. Product Codes in the tables refer to primed products. For Painted products add the suffix /PA to the Product Code reference.

Apex Heritage - Cast Iron Bracketry

Alumasc can provide traditional style Bracketry for all its standard Apex Heritage gutter profiles. Where building detailing dictates, Alumasc can provide bespoke Bracketry to meet individual project requirements.

Traditional 'Old' Style Gutter Brackets

Top Fix Rafter Arm - Half Round

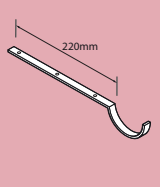
	Gutter Size	Product Code
	100	HG40/RB/TF
	113	HG45/RB/TF
	125	HG50/RB/TF
	150	HG60/RB/TF

Top Fix Rafter Arm - Beaded Half Round

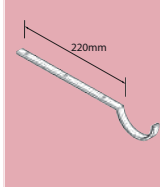
	Gutter Size	Product Code
	113	BG45/RB/TF
	125	BG50/RB/TF

Top Fix Rafter Arm - Victorian Ogee

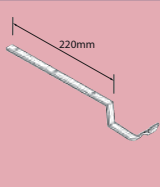
	Gutter Size	Product Code
	113	OG45/RB/TF
	125	OG50/RB/TF

Top Fix Rafter Arm - Moulded

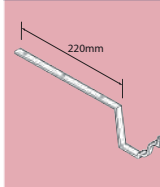
	Gutter Size	Product Code
	100 x 75	MG43/RB/TF
	125 x 100	MG54/RB/TF
	150 x 100	MG64/RB/TF

Side Fix Rafter Arm - Half Round

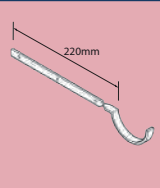
	Gutter Size	Product Code
	100	HG40/RB/SF
	113	HG45/RB/SF
	125	HG50/RB/SF
	152	HG60/RB/SF

Side Fix Rafter Arm - Beaded Half Round/Deep Run

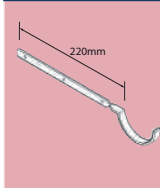
	Gutter Size	Product Code
	113	BG45/RB/SF
	125	BG50/RB/SF

Side Fix Rafter Arm - Victorian Ogee

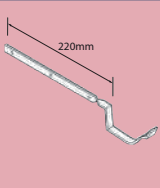
	Gutter Size	Product Code
	113	OG45/RB/SF
	125	OG50/RB/SF

Side Fix Rafter Arm - Moulded

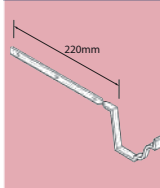
	Gutter Size	Product Code
	100 x 75	MG43/RB/SF
	125 x 100	MG54/RB/SF
	150 x 100	MG64/RB/SF

Note: Products are available with an oxide primed coating or with a certified factory painted finish. Product Codes in the tables refer to primed products. For Painted products add the suffix /PA to the Product Code reference.

Apex Heritage - Cast Iron Bracketry

Drive in Rise & Fall - Half Round

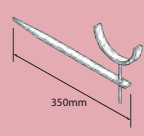
	Gutter Size	Product Code
	100	HG40/R&F/GS
	113	HG45/R&F/GS
	125	HG50/R&F/GS
	150	HG60/R&F/GS

Drive in Rise & Fall - Beaded Half Round

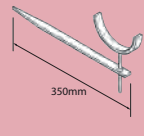
	Gutter Size	Product Code
	113	BG45/R&F/GS
	125	BG50/R&F/GS

Drive in Rise & Fall - Victorian Ogee

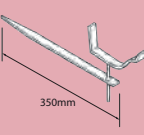
	Gutter Size	Product Code
	113	OG45/R&F/GS
	125	OG50/R&F/GS

Drive in Rise & Fall - Moulded

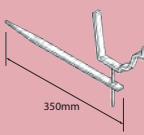
	Gutter Size	Product Code
	100 x 75	MG43/R&F/GS
	125 x 100	MG54/R&F/GS
	150 x 100	MG64/R&F/GS

Drive in Rise & Fall with 330mm Stay - Half Round

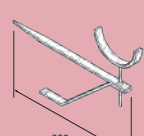
	Gutter Size	Product Code
	100	HG40/R&F/WS
	113	HG45/R&F/WS
	125	HG50/R&F/WS
	150	HG60/R&F/WS

Drive in Rise & Fall with 330mm Stay - Beaded Half Round

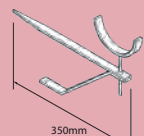
	Gutter Size	Product Code
	113	BG45/R&F/WS
	125	BG50/R&F/WS

Drive in Rise & Fall with 330mm Stay - Victorian Ogee

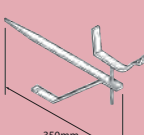
	Gutter Size	Product Code
	113	OG45/R&F/WS
	125	OG50/R&F/WS

Drive in Rise & Fall with 330mm Stay - Moulded

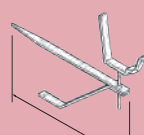
	Gutter Size	Product Code
	100 x 75	MG43/R&F/WS
	125 x 100	MG54/R&F/WS
	150 x 100	MG64/R&F/WS



Bespoke Bracketry

Alumasc can design and manufacture a variety of Bracketry solutions for gutters and pipes to create an integrated system solution. Such detailing can often be used to support fascia and soffit configurations.

Ornate holderbats and earbells can be detailed to provide a unique, distinguished appearance to a rainwater stack.

Where standard fitting dimensions do not suit the project's requirements, Alumasc can fabricate its gutter and pipe Bracketry systems to accommodate building design.

Note: Products are available with an oxide primed coating or with a certified factory painted finish. Product Codes in the tables refer to primed products. For Painted products add the suffix /PA to the Product Code reference.

Apex Heritage - Circular Pipes and Fittings



A range of traditional cast iron socketed round rainwater pipes in a choice of 3 pipe diameters and 2 pipe lengths. There is a comprehensive range of cast iron fittings, and traditional holderbat and earbelt fixings. Cast iron rainwater hopper heads are also available to suit.

Note: All dimensions shown are in mm unless shown otherwise.
Pipe sizes shown are nominal.

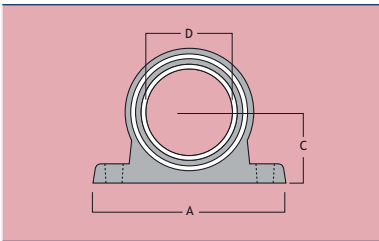

Sockets (Nominal)	63	75	100
A Width of flange	146	162	191
B Depth of socket	63.5	63.5	63.5
C Distance of centre to wall	48	54	67
D Internal dia	73	90	111

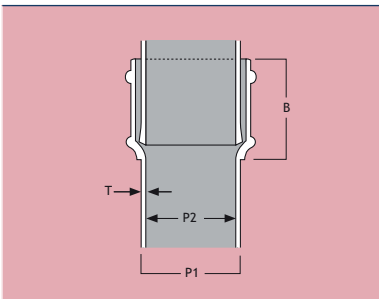

Pipes (Nominal)	63	75	100
P1 External dia	63.5	82.5	108
P2 Internal dia	57	70	95
T Thickness	3	3	3

Notes:

- If bends with ears are required, add one of the following suffixes to the Product Code according to its intended use:
 - front bend /FE
 - back bend /BE
 - lefthand bend /LE
 - righthand bend /RE
- If plinth offsets with ears are required, add suffix PE to the Product Code.
- Swan-necks can also be used as side offsets. If side offsets with ears are required, add one of the following suffixes to the Product Code according to its intended use:
 - lefthand side offset /LE
 - righthand side offset /RE
- Shoes can also be used as side shoes. If side shoes with ears are required, add one of the following suffixes to the Product Code according to its intended use:
 - lefthand side shoe /LE
 - righthand side shoe /RE
- If shoes with ears are required, add suffix E to the Product Code.
- If ears are required on single branches or diminishing pieces, please contact Alumasc Technical Services department for further details.
- Should projections other than those shown be required for plinth offsets or swan-necks, please contact Alumasc Technical Services for further details.

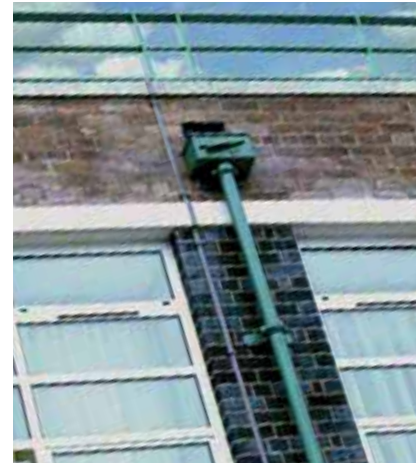

Note: Products are available with an oxide primed coating or with a certified factory painted finish. Product Codes in the tables refer to primed products. For Painted products add the suffix /PA to the Product Code reference.

Apex Heritage - Circular Pipes and Fittings

Pipes - With and Without Ears

Pipe Size	A	Product Code
63 dia	915	P25/3FT
75 dia	915	P30/3FT
100 dia	915	P40/3FT
63 dia	1830	P25/6FT
75 dia	1830	P30/6FT
100 dia	1830	P40/6FT

Note: The codes given above are for pipes with ears. For pipes without ears suffix codes with /NE

Bends

Pipe Size	Bend	A	B	C	Product Code
63 dia	92.5 Degree	63	76	140	P25/B/92
75 dia	"	63	83	146	P30/B/92
100 dia	"	63	95	159	P40/B/92
63 dia	112.5 Degree	63	57	121	P25/B/112
75 dia	"	63	60	124	P30/B/112
100 dia	"	63	70	133	P40/B/112
63 dia	135 Degree	63	44	108	P25/B/135
75 dia	"	63	48	111	P30/B/135
100 dia	"	63	51	114	P40/B/135

Note: If bends with ears are required, add one of the following suffixes to the Product Code:
Front Bend /FE Back Bend /BE Left Hand Bend /LE Right Hand Bend /RE.

Branches

Pipe Size	Branches	A	B	C	Product Code
63 dia	92.5 Degree	63	210	79	P25/BR/92
75 dia	"	63	229	79	P30/BR/92
100 dia	"	63	267	98	P40/BR/92
63 dia	112.5 Degree	63	210	79	P25/BR/112
75 dia	"	63	229	89	P30/BR/112
100 dia	"	63	267	108	P40/BR/112
63 dia	135 Degree	63	210	108	P25/BR/135
75 dia	"	63	229	124	P30/BR/135
100 dia	"	63	267	152	P40/BR/135

Note: If ears are required on single branches contact Alumasc Technical Services.

Drive in Pipe Support

Pipe Size	A	Product Code
63 dia	300	P25/HF
75 dia	300	P30/HF
100 dia	300	P40/HF

Note: Products are available with an oxide primed coating or with a certified factory painted finish.
Product Codes in the tables refer to primed products. For Painted products add the suffix /PA to the Product Code reference.

Apex Heritage - Circular Pipes and Fittings

Side Offsets, Plinth Offsets and Swan Necks

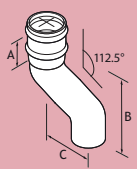

Pipe Size	Branches	A	B	C	Product Code
63 dia	112.5 Degree	63	190	76	P25/OF/03
63 dia	"	63	210	114	P25/OF/04
63 dia	"	63	225	152	P25/OF/06
63 dia	"	63	257	229	P25/OF/09
63 dia	"	63	289	306	P25/OF/12
63 dia	"	63	321	381	P25/OF/15
63 dia	"	63	352	457	P25/OF/18
75 dia	112.5 Degree	63	200	76	P30/OF/03
75 dia	"	63	216	114	P30/OF/04
75 dia	"	63	232	152	P30/OF/06
75 dia	"	63	264	229	P30/OF/09
75 dia	"	63	295	306	P30/OF/12
75 dia	"	63	327	381	P30/OF/15
75 dia	"	63	359	457	P30/OF/18
100 dia	112.5 Degree	63	219	76	P40/OF/03
100 dia	"	63	235	114	P40/OF/04
100 dia	"	63	248	152	P40/OF/06
100 dia	"	63	279	229	P40/OF/09
100 dia	"	63	311	306	P40/OF/12
100 dia	"	63	343	381	P40/OF/15
100 dia	"	63	375	457	P40/OF/18

Note: If offsets with ears are required, add one of the following suffixes to the Product Code:
 Left Hand Side Offset /LE Right Hand Side Offset /RE.
 Other sizes are available on request.

Access Pipes - Without Ears

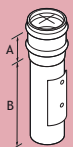

Pipe Size	A	B	Product Code
63 dia	63	343	P25/AP/NE
75 dia	63	343	P30/AP/NE
100 dia	63	343	P40/AP/NE

Access Pipes - With Ears

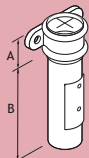

Pipe Size	A	B	Product Code
63 dia	63	343	P25/AP
75 dia	63	343	P30/AP
100 dia	63	343	P40/AP

Note: Products are available with an oxide primed coating or with a certified factory painted finish.
 Product Codes in the tables refer to primed products. For Painted products add the suffix /PA to the Product Code reference.

Apex Heritage - Circular Pipes and Fittings

Diminishing Pieces

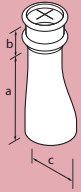
	Pipe Size	A	B	C	Product Code
	100 dia	140	63	63	P40/DIM/25
	100 dia	140	63	76	P40/DIM/30

Shoes

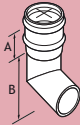
	Pipe Size	Type	A	B	C	Product Code
	63 dia	Regular	63	102	-	P25/SH
	75 dia	"	63	114	-	P35/SH
	100 dia	"	63	143	-	P40/SH
	63 dia	Anti-splash	63	159	149	P25/SH/A
	75 dia	"	63	175	171	P35/SH/A
	100 dia	"	63	197	206	P40/SH/A

Note: If shoes are required add /E to the Product Code.
Shoes used as side shoes for a left hand side shoe with ears add /LE. For a right hand side shoe add /RE.

Rainwater Heads

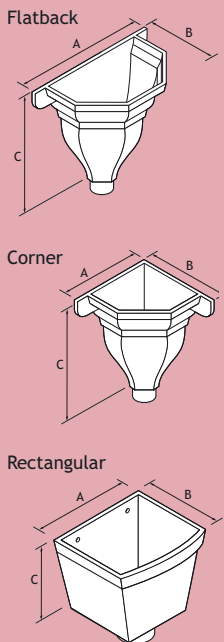
	Pipe Size	Type	A	B	C	Product Code
	63 dia	Flatback	298	190	210	HH/001/25F
	75 dia	"	298	190	210	HH/001/30F
	100 dia	"	337	229	241	HH/001/40F
	63 dia	Corner	210	210	210	HH/001/25C
	75 dia	"	210	210	210	HH/001/30C
	100 dia	"	235	235	241	HH/001/40C
	63 dia	Small Rectangular	254	178	178	HH/002/25
	75 dia	"	254	178	178	HH/002/30
	100 dia	"	254	178	178	HH/002/40
	63 dia	Large Rectangular	305	250	250	HH/003/25
	75 dia	"	305	250	250	HH/003/30
	100 dia	"	305	254	203	HH/003/40

Note: Products are available with an oxide primed coating or with a certified factory painted finish.
Product Codes in the tables refer to primed products. For Painted products add the suffix /PA to the Product Code reference.

Apex Heritage - Square and Rectangular Pipes and Fittings



A range of traditional cast iron socketed square and rectangular rainwater pipes in a choice of 5 pipe sizes and 2 pipe lengths. There is a comprehensive range of cast iron fittings and traditional earbelt fixings. Cast iron rainwater hopper heads are also available to suit.

Note: All dimensions shown are in mm unless shown otherwise.
Pipe sizes shown are nominal.

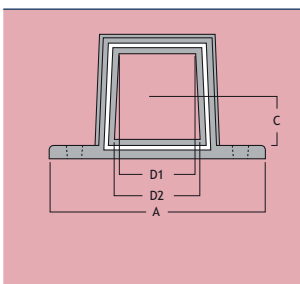

Sockets (Nominal)	75 x 75	100 x 75	100 x 100	125 x 100	150 x 100
A Width of flange	180	205	205	230	250
B Depth of socket	83	83	108	108	108
C Distance of centre to wall	50	50	65	65	65
D1 Internal dimension front	86	111	111	136.5	162
D2 Internal dimension back	89	114	114	140	165

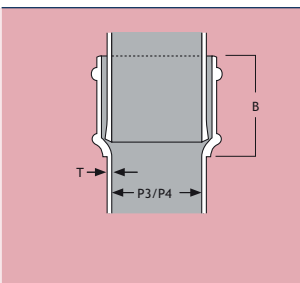

Pipes (Nominal)	75 x 75	100 x 75	100 x 100	125 x 100	150 x 100
P1 External dimension front	82.5	108	108	133.5	159
P2 External dimension back	86	111	111	136.5	162
P3 Internal dimension front	70	95.5	95.5	121	146
P4 Internal dimension back	73	98.5	98.5	124	149
T Thickness	6.5	6.5	6.5	6.5	6.5

Notes:

- Dimensions of rectangular pipes are given with the width as viewed from the front first, followed by the depth, front to back - eg, 150 wide x 100 depth.
- If ears are required, add suffix /E to the Product Code.
- If ears are required on single branches or swan-necks, please contact our Customer Services department for further details.
- Shoes can also be used as side shoes. If side shoes with ears are required, add one of the following suffixes to the Product Code according to its intended use:
 - lefthand side shoe /LE
 - righthand side shoe /RE
- Should projections other than those shown be required for swan-necks, plinth offsets or side offsets, please contact Alumasc Technical Services department for further details.
- The majority of fittings illustrated in this section are available 'From stock'. However, extended lead times might be required for some items.

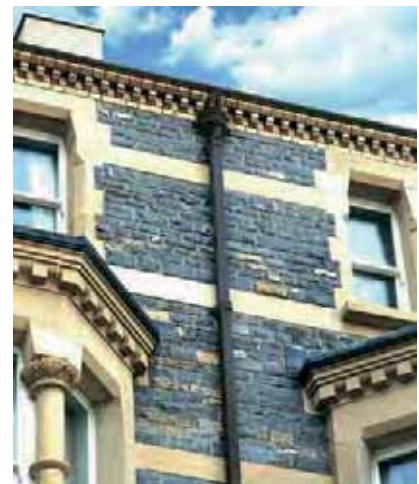

Note: Products are available with an oxide primed coating or with a certified factory painted finish. Product Codes in the tables refer to primed products. For Painted products add the suffix /PA to the Product Code reference.

Apex Heritage - Square and Rectangular Pipes and Fittings

Pipes - With and Without Ears

	Pipe Size	A	Product Code
	75 x 75	915	P33/3FT
	75 x 100	915	P43/3FT
	100 x 100	915	P44/3FT
	125 x 100	915	P54/3FT
	150 x 100	915	P64/3FT
	75 x 75	1830	P33/6FT
	75 x 100	1830	P43/6FT
	100 x 100	1830	P44/6FT
	125 x 100	1830	P54/6FT
	150 x 100	1830	P64/6FT

Note: The codes given above are for pipes with ears. For pipes without ears suffix codes with /NE

Bends - Front/Back

	Pipe Size	Bend	A	B	C	Product Code
	75 x 75	92.5 Degree	82	83	165	P33/B/92B/F
	75 x 100	"	82	83	165	P43/B/92B/F
	100 x 100	"	82	95	178	P44/B/92B/F
	125 x 100	"	82	95	178	P54/B/92B/F
	150 x 100	"	82	95	178	P64/B/92B/F
	75 x 75	112.5 Degree	82	60	143	P33/B/112B/F
	75 x 100	"	82	60	143	P43/B/112B/F
	100 x 100	"	82	70	152	P44/B/112B/F
	125 x 100	"	82	70	152	P54/B/112B/F
	150 x 100	"	82	70	152	P64/B/112B/F
	75 x 75	135 Degree	82	48	130	P33/B/135B/F
	75 x 100	"	82	48	130	P43/B/135B/F
	100 x 100	"	82	51	133	P44/B/135B/F
	125 x 100	"	82	51	133	P54/B/135B/F
	150 x 100	"	82	51	133	P64/B/135B/F

Note: If bends with ears are required, add suffix /E to the Product Code.
The Product Code for Apex Cast Iron Front/Back bends should be suffixed F for Front or B for Back bends as appropriate.

Note: Products are available with an oxide primed coating or with a certified factory painted finish.
Product Codes in the tables refer to primed products. For Painted products add the suffix /PA to the Product Code reference.

Apex Heritage - Square and Rectangular Pipes and Fittings

Bends - Left/Right

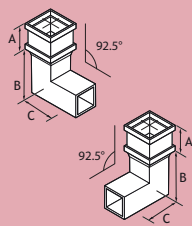
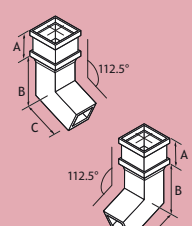
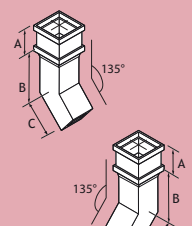
	Pipe Size	Type	Angle	A	B	C	Product Code
	75 x 75	Left	92.5 Degree	82	108	190	P33/B/92L
	75 x 100	Left	"	82	121	203	P43/B/92L
	100 x 100	Left	"	82	121	203	P44/B/92L
	125 x 100	Left	"	82	133	216	P54/B/92L
	150 x 100	Left	"	82	146	229	P64/B/92L
	75 x 75	Right	"	82	108	190	P33/B/92R
	75 x 100	Right	"	82	121	203	P43/B/92R
	100 x 100	Right	"	82	121	203	P44/B/92R
	125 x 100	Right	"	82	133	216	P54/B/92R
	150 x 100	Right	"	82	146	229	P64/B/92R
	75 x 75	Left	112.5 Degree	82	86	168	P33/B/112L
	75 x 100	Left	"	82	95	178	P43/B/112L
	100 x 100	Left	"	82	95	178	P44/B/112L
	125 x 100	Left	"	82	105	187	P54/B/112L
	150 x 100	Left	"	82	114	197	P64/B/112L
	75 x 75	Right	"	82	86	168	P33/B/112R
	75 x 100	Right	"	82	95	178	P43/B/112R
	100 x 100	Right	"	82	95	178	P44/B/112R
	125 x 100	Right	"	82	105	187	P54/B/112R
	150 x 100	Right	"	82	114	197	P64/B/112R
	75 x 75	Left	135 Degree	82	73	156	P33/B/135L
	75 x 100	Left	"	82	76	158	P43/B/135L
	100 x 100	Left	"	82	76	158	P44/B/135L
	125 x 100	Left	"	82	83	165	P54/B/135L
	150 x 100	Left	"	82	89	171	P64/B/135L
	75 x 75	Right	"	82	73	156	P33/B/135R
	75 x 100	Right	"	82	76	158	P43/B/135R
	100 x 100	Right	"	82	76	158	P44/B/135R
	125 x 100	Right	"	82	83	165	P54/B/135R
	150 x 100	Right	"	82	89	171	P64/B/135R
Note: If bends with ears are required, add suffix /E to the Product Code.							

Note: Products are available with an oxide primed coating or with a certified factory painted finish.
Product Codes in the tables refer to primed products. For Painted products add the suffix /PA to the Product Code reference.

Apex Heritage - Square and Rectangular Pipes and Fittings

Branches

	Pipe Size	Type	Angle	A	B	C	Product Code	
	75 x 75	Left	92.5 Degree	82	273	83	P33/BR/92L	
	75 x 100	Left	"	82	298	98	P43/BR/92L	
	100 x 100	Left	"	82	298	98	P44/BR/92L	
	125 x 100	Left	"	82	324	111	P54/BR/92L	
	150 x 100	Left	"	82	349	124	P64/BR/92L	
	75 x 75	Right	"	82	273	83	P33/BR/92R	
	75 x 100	Right	"	82	298	98	P43/BR/92R	
	100 x 100	Right	"	82	298	98	P44/BR/92R	
	125 x 100	Right	"	82	324	111	P54/BR/92R	
	150 x 100	Right	"	82	349	124	P64/BR/92R	
		75 x 75	Left	112.5 Degree	82	273	102	P33/BR/112L
		75 x 100	Left	"	82	298	121	P43/BR/112L
100 x 100		Left	"	82	298	121	P44/BR/112L	
125 x 100		Left	"	82	324	146	P54/BR/112L	
150 x 100		Left	"	82	349	159	P64/BR/112L	
75 x 75		Right	"	82	273	102	P33/BR/112R	
75 x 100		Right	"	82	298	121	P43/BR/112R	
100 x 100		Right	"	82	298	121	P44/BR/112R	
125 x 100		Right	"	82	324	146	P54/BR/112R	
150 x 100		Right	"	82	349	159	P64/BR/112R	
		75 x 75	Left	135 Degree	82	340	146	P33/BR/135L
		75 x 100	Left	"	82	375	175	P43/BR/135L
	100 x 100	Left	"	82	375	175	P44/BR/135L	
	125 x 100	Left	"	82	416	203	P54/BR/135L	
	150 x 100	Left	"	82	451	235	P64/BR/135L	
	75 x 75	Right	"	82	340	146	P33/BR/135R	
	75 x 100	Right	"	82	375	175	P43/BR/135R	
	100 x 100	Right	"	82	375	175	P44/BR/135R	
	125 x 100	Right	"	82	416	203	P54/BR/135R	
	150 x 100	Right	"	82	451	235	P64/BR/135R	

Note: If branches with ears are required, add suffix /E to the Product Code.

Note: Products are available with an oxide primed coating or with a certified factory painted finish.
Product Codes in the tables refer to primed products. For Painted products add the suffix /PA to the Product Code reference.

Apex Heritage - Square and Rectangular Pipes and Fittings

Offsets - Left/Right 75 x 75

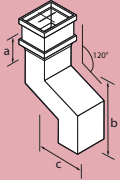

Pipe Size	Type	Angle	A	B	C	Product Code
75 x 75	Left	112.5 Degree	82	286	76	P33/OF/03L
75 x 75	Left	"	82	302	114	P33/OF/04L
75 x 75	Left	"	82	317	152	P33/OF/06L
75 x 75	Left	"	82	349	228	P33/OF/09L
75 x 75	Left	"	82	381	305	P33/OF/12L
75 x 75	Left	"	82	413	381	P33/OF/15L
75 x 75	Left	"	82	444	457	P33/OF/18L
75 x 75	Right	"	82	286	76	P33/OF/03R
75 x 75	Right	"	82	302	114	P33/OF/04R
75 x 75	Right	"	82	317	152	P33/OF/06R
75 x 75	Right	"	82	349	228	P33/OF/09R
75 x 75	Right	"	82	381	305	P33/OF/12R
75 x 75	Right	"	82	413	381	P33/OF/15R
75 x 75	Right	"	82	444	457	P33/OF/18R
75 x 75	Swan Neck	120 Degree	82	286	76	P33/OF/03
75 x 75	Swan Neck	"	82	302	114	P33/OF/04
75 x 75	Swan Neck	"	82	317	152	P33/OF/06
75 x 75	Swan Neck	"	82	349	228	P33/OF/09
75 x 75	Swan Neck	"	82	381	305	P33/OF/12
75 x 75	Swan Neck	"	82	413	381	P33/OF/15
75 x 75	Swan Neck	"	82	444	457	P33/OF/18
75 x 75	Plinth Offset	135 Degree	82	317	63	P33/OF/02P
75 x 75	Plinth Offset	"	82	330	76	P33/OF/03P
75 x 75	Plinth Offset	"	82	368	114	P33/OF/04P
75 x 75	Plinth Offset	"	82	-	152	P33/OF/06P

Offsets - Left/Right 100 x 75

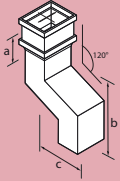

Pipe Size	Type	Angle	A	B	C	Product Code
100 x 75	Left	112.5 Degree	82	302	76	P43/OF/03L
100 x 75	Left	"	82	317	114	P43/OF/04L
100 x 75	Left	"	82	333	152	P43/OF/06L
100 x 75	Left	"	82	365	228	P43/OF/09L
100 x 75	Left	"	82	397	305	P43/OF/12L
100 x 75	Left	"	82	429	381	P43/OF/15L
100 x 75	Left	"	82	460	457	P43/OF/18L
100 x 75	Right	"	82	302	76	P43/OF/03R
100 x 75	Right	"	82	317	114	P43/OF/04R
100 x 75	Right	"	82	333	152	P43/OF/06R
100 x 75	Right	"	82	365	228	P43/OF/09R
100 x 75	Right	"	82	379	305	P43/OF/12R
100 x 75	Right	"	82	429	381	P43/OF/15R
100 x 75	Right	"	82	460	457	P43/OF/18R
100 x 75	Swan Neck	120 Degree	82	302	76	P43/OF/03
100 x 75	Swan Neck	"	82	317	114	P43/OF/04
100 x 75	Swan Neck	"	82	333	152	P43/OF/06
100 x 75	Swan Neck	"	82	365	228	P43/OF/09
100 x 75	Swan Neck	"	82	397	305	P43/OF/12
100 x 75	Swan Neck	"	82	429	381	P43/OF/15
100 x 75	Swan Neck	"	82	460	457	P43/OF/18
100 x 75	Plinth Offset	135 Degree	82	317	63	P43/OF/02P
100 x 75	Plinth Offset	"	82	330	76	P43/OF/03P
100 x 75	Plinth Offset	"	82	368	114	P43/OF/04P
100 x 75	Plinth Offset	"	82	406	152	P43/OF/06P

Note: Products are available with an oxide primed coating or with a certified factory painted finish.
Product Codes in the tables refer to primed products. For Painted products add the suffix /PA to the Product Code reference.

Apex Heritage - Square and Rectangular Pipes and Fittings

Offsets - Left/Right 100 x 100



Pipe Size	Type	Angle	A	B	C	Product Code
100 x 100	Left	112.5 Degree	82	302	76	P44/OF/03L
100 x 100	Left	"	82	317	114	P44/OF/04L
100 x 100	Left	"	82	333	152	P44/OF/06L
100 x 100	Left	"	82	365	228	P44/OF/09L
100 x 100	Left	"	82	397	305	P44/OF/12L
100 x 100	Left	"	82	429	381	P44/OF/15L
100 x 100	Left	"	82	460	457	P44/OF/18L
100 x 100	Right	"	82	302	76	P44/OF/03R
100 x 100	Right	"	82	317	114	P44/OF/04R
100 x 100	Right	"	82	333	152	P44/OF/06R
100 x 100	Right	"	82	365	228	P44/OF/09R
100 x 100	Right	"	82	397	305	P44/OF/12R
100 x 100	Right	"	82	429	381	P44/OF/15R
100 x 100	Right	"	82	460	457	P44/OF/18R
100 x 100	Swan Neck	120 Degree	82	302	76	P44/OF/03
100 x 100	Swan Neck	"	82	317	114	P44/OF/04
100 x 100	Swan Neck	"	82	333	152	P44/OF/06
100 x 100	Swan Neck	"	82	365	228	P44/OF/09
100 x 100	Swan Neck	"	82	397	305	P44/OF/12
100 x 100	Swan Neck	"	82	429	381	P44/OF/15
100 x 100	Swan Neck	"	82	460	457	P44/OF/18
100 x 100	Plinth Offset	135 Degree	82	324	63	P44/OF/02P
100 x 100	Plinth Offset	"	82	340	76	P44/OF/03P
100 x 100	Plinth Offset	"	82	375	114	P44/OF/04P
100 x 100	Plinth Offset	"	82	416	152	P44/OF/06P

Offsets - Left/Right 125 x 100

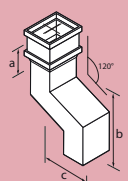

Pipe Size	Type	Angle	A	B	C	Product Code
125 x 100	Left	112.5 Degree	82	317	76	P54/OF/03L
125 x 100	Left	"	82	333	114	P54/OF/04L
125 x 100	Left	"	82	349	152	P54/OF/06L
125 x 100	Left	"	82	381	228	P54/OF/09L
125 x 100	Left	"	82	413	305	P54/OF/12L
125 x 100	Left	"	82	444	381	P54/OF/15L
125 x 100	Left	"	82	476	457	P54/OF/18L
125 x 100	Right	"	82	317	76	P54/OF/03R
125 x 100	Right	"	82	333	114	P54/OF/04R
125 x 100	Right	"	82	349	152	P54/OF/06R
125 x 100	Right	"	82	381	228	P54/OF/09R
125 x 100	Right	"	82	413	305	P54/OF/12R
125 x 100	Right	"	82	444	381	P54/OF/15R
125 x 100	Right	"	82	476	457	P54/OF/18R
125 x 100	Swan Neck	120 Degree	82	317	76	P54/OF/03
125 x 100	Swan Neck	"	82	333	114	P54/OF/04
125 x 100	Swan Neck	"	82	349	152	P54/OF/06
125 x 100	Swan Neck	"	82	381	228	P54/OF/09
125 x 100	Swan Neck	"	82	413	305	P54/OF/12
125 x 100	Swan Neck	"	82	444	381	P54/OF/15
125 x 100	Swan Neck	"	82	476	457	P54/OF/18
125 x 100	Plinth Offset	135 Degree	82	324	63	P54/OF/02P
125 x 100	Plinth Offset	"	82	340	76	P54/OF/03P
125 x 100	Plinth Offset	"	82	375	114	P54/OF/04P
125 x 100	Plinth Offset	"	82	416	152	P54/OF/06P

Note: Products are available with an oxide primed coating or with a certified factory painted finish.
Product Codes in the tables refer to primed products. For Painted products add the suffix /PA to the Product Code reference.

Apex Heritage - Square and Rectangular Pipes and Fittings

Offsets - Left/Right 150 x 100

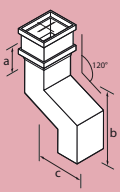

Pipe Size	Type	Angle	A	B	C	Product Code
150 x 100	Left	112.5 Degree	82	337	76	P64/OF/03L
150 x 100	Left	"	82	352	114	P64/OF/04L
150 x 100	Left	"	82	368	152	P64/OF/06L
150 x 100	Left	"	82	400	228	P64/OF/09L
150 x 100	Left	"	82	432	305	P64/OF/12L
150 x 100	Left	"	82	464	381	P64/OF/15L
150 x 100	Left	"	82	495	457	P64/OF/18L
150 x 100	Right	"	82	337	76	P64/OF/03R
150 x 100	Right	"	82	352	114	P64/OF/04R
150 x 100	Right	"	82	368	152	P64/OF/06R
150 x 100	Right	"	82	400	228	P64/OF/09R
150 x 100	Right	"	82	432	305	P64/OF/12R
150 x 100	Right	"	82	464	381	P64/OF/15R
150 x 100	Right	"	82	495	457	P64/OF/18R
150 x 100	Swan Neck	120 Degree	82	337	76	P64/OF/03
150 x 100	Swan Neck	"	82	352	114	P64/OF/04
150 x 100	Swan Neck	"	82	368	152	P64/OF/06
150 x 100	Swan Neck	"	82	400	228	P64/OF/09
150 x 100	Swan Neck	"	82	432	305	P64/OF/12
150 x 100	Swan Neck	"	82	464	381	P64/OF/15
150 x 100	Swan Neck	"	82	495	457	P64/OF/18
150 x 100	Plinth Offset	135 Degree	82	324	63	P64/OF/02P
150 x 100	Plinth Offset	"	82	340	76	P64/OF/03P
150 x 100	Plinth Offset	"	82	375	114	P64/OF/04P
150 x 100	Plinth Offset	"	82	416	152	P64/OF/06P

Note: If ears are required on 112.5° and 135° offsets, add suffix /E to the Product Code.

Note: Products are available with an oxide primed coating or with a certified factory painted finish.
Product Codes in the tables refer to primed products. For Painted products add the suffix /PA to the Product Code reference.

Apex Heritage - Square and Rectangular Pipes and Fittings

Shoes

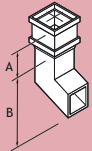
	Pipe Size	A	B	Product Code
	75 x 75	82	159	P33/SH
	100 x 75	82	159	P43/SH
	100 x 100	82	184	P44/SH
	125 x 100	82	184	P54/SH
	150 x 100	82	184	P64/SH

Anti Splash Shoes

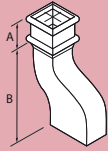
	Pipe Size	A	B	Product Code
	75 x 75	82	171	P33/SH/A
	100 x 75	82	171	P43/SH/A
	100 x 100	82	197	P44/SH/A
	125 x 100	82	197	P54/SH/A
	150 x 100	82	197	P64/SH/A

Corner Shoes

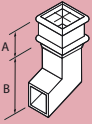
	Pipe Size	A	B	Product Code
	75 x 75	82	187	P33/SH/C
	100 x 100	82	229	P44/SH/C

Note: Shoes can also be used as side shoes.
Add one of the following suffixes to the Product Code according to its intended use:
left hand side shoe /L right hand side shoe /R. If ears are required, add suffix /E to the Product Code.

Rainwater Heads

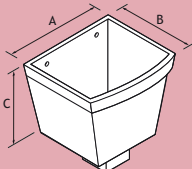
	Pipe Size	Type	A	B	C	Product Code
	75 x 75	Small Rectangular	254	178	178	HH/002/33
	100 x 75	"	254	178	178	HH/002/43
	100 x 100	"	254	178	178	HH/002/44
	75 x 75	Large Rectangular	305	250	250	HH/003/33
	100 x 75	"	305	254	302	HH/003/43
	100 x 100	"	305	254	302	HH/003/44
	125 x 100	"	305	254	302	HH/003/54

Square to Circular Connectors

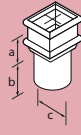
	Pipe Size	A	B	C	Product Code
	75 x 75	82	95	108	P33/C
	100 x 75	82	95	108	P43/C
	100 x 100	82	95	108	P44/C
	125 x 100	82	95	108	P54/C
	150 x 100	82	95	108	P64/C

Note: Products are available with an oxide primed coating or with a certified factory painted finish.
Product Codes in the tables refer to primed products. For Painted products add the suffix /PA to the Product Code reference.

Alumasc Rainwater Systems The Cast Iron Made to Order Range

This rainwater range, featuring the
Apex Heritage System Made to Order,
extends the choices available with the
Apex Heritage System standard range components.

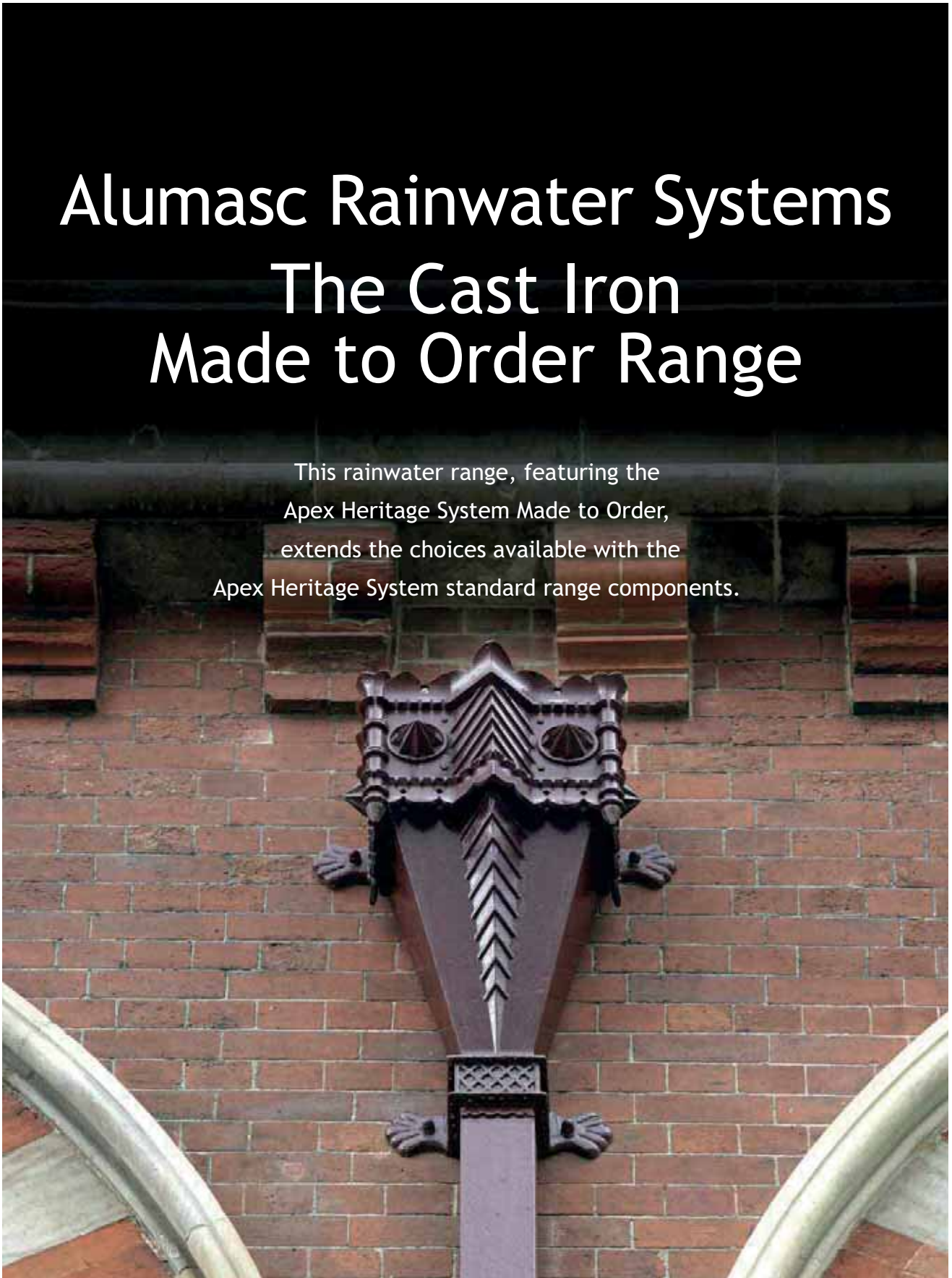

Made to Order Cast Iron Rainwater Range - Introduction



Alumasc Rainwater's Made-to-Order Cast Iron range is specifically designed to yield all of the benefits associated with the standard Apex Heritage range, satisfying all the style options for new buildings whilst addressing the challenges of exact replacement for refurbishment and restoration.



Gutters



Hoppers



Downpipes



Accessories

Design Flexibility

Alumasc's history of designing and supplying engineered rainwater systems is a sign of its ability to develop patterns for the sand casting of products that are tailored to individual buildings' specific needs.

The Apex Heritage Made-to-Order range offers the specifier a considerable choice of readily available plain and ornamental pipes, rainwater heads and gutter profiles, including radius gutters in traditional sand cast iron.

A variety of different designs are possible for decorative earbelts and additional enrichments that can be added onto rainwater heads.

Where an existing installation has to be replaced, in particular on listed building, Alumasc can provide new castings to match the existing design. Where gutters are required to follow a particular roof radius, patterns can be engineered from dimensions or existing gutter installations to yield a gutter that can be installed to suit the roof parameters. Alumasc is happy to offer technical advice and quotations for additional designs where these might be required.

Cast Iron Specialist

To further support Alumasc Rainwater product offer and technical support service we now have a Cast Iron Specialist in the technical team who is concentrating closely on bespoke Cast Iron rainwater solutions, providing design advice and technical support to Architects, Specifiers and Contractors.

To discuss your project requirements please contact the
Cast Iron Specialist
on
Tel: 01536 720 523



Apex Heritage - Made to Order Gutters

Half Round Gutters

Gutter Size	Type	Product Code
127 x 140	Deep, beaded, collar	SG22/6FT
152 x 70	Beaded, collar	SG25/6FT
200 x 81	Deep	SG77/6FT

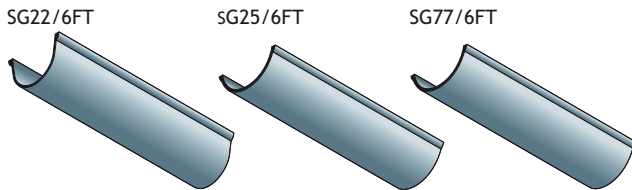

Box Gutters

Gutter Size	Type	Product Code
114 x 76	Collar	SG31/6FT
114 x 89	Right hand spigot	SG20/6FT
140 x 102	Right hand collar	SG26/6FT
140 x 102	Right hand spigot	SG08/6FT
152 x 140	Right hand spigot	SG09/6FT

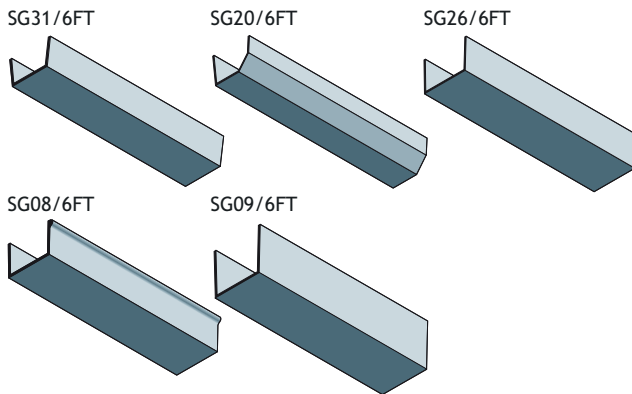

Ogee Gutters

Gutter Size	Type	Product Code
114 x 76	Right hand spigot	SG17/6FT
127 x 70	Left hand collar	SG29/6FT
127 x 76	Left hand collar	SG13/6FT
127 x 102	Right hand spigot	SG18/6FT
152 x 102	Right hand spigot	SG19/6FT

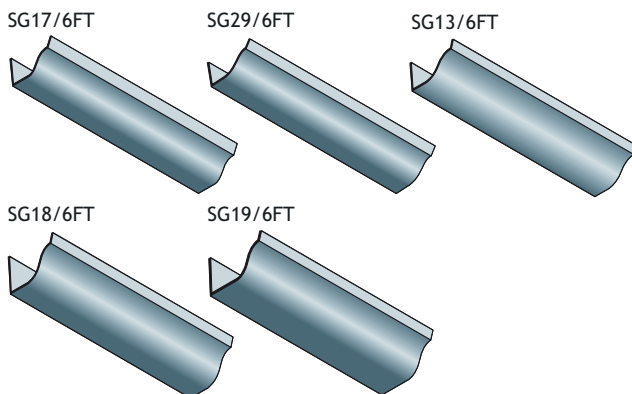

Gutters can be made to order in any shape – half round, box, ogee or moulded.

Radiused gutters can also be produced.

All are available with fittings to accommodate any situation: 90° external or internal angle, running outlet, union clip or LH stopend (inside gutter).

Moulded Gutters

Gutter Size	Type	Product Code
133 x 82	Right hand spigot	SG39/6FT
165 x 152	Left hand spigot	SG37/6FT
178 x 152	Right hand spigot	SG05/6FT
190 x 89	Right hand spigot	SG07/6FT
203 x 127	Right hand collar	SG10/6FT
203 x 127	Right hand spigot	SG30/6FT
203 x 152	Right hand spigot	SG12/6FT
229 x 152	Right hand spigot	SG03/6FT
260 x 146	Right hand spigot	SG14/6FT
305 x 152	Left hand spigot	SG15/6FT

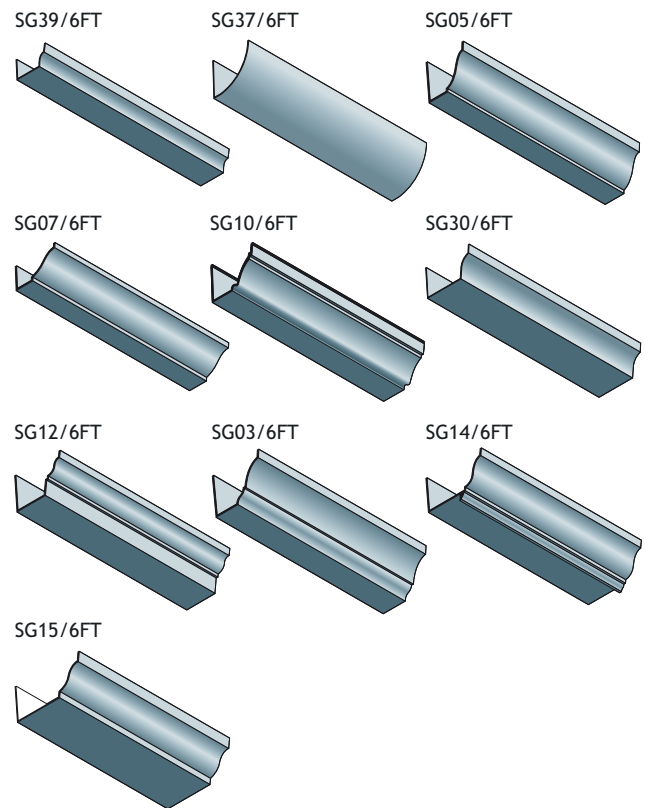

Please contact us for more information on made-to-order gutters.

Apex Heritage - Made to Order Rainwater Heads

This page shows the Apex Heritage made to order range of decorative rainwater heads. These products are readily available because Alumasc holds the patterns and can produce the items to order.



Made To Order Rainwater Heads

Ref HH/011

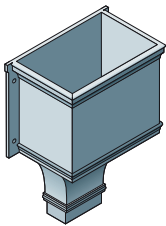

Ref HH/040

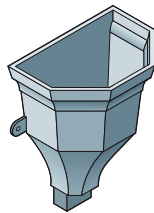

Ref HH/082

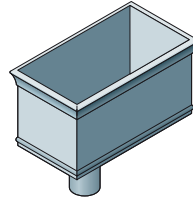

Ref HH/132

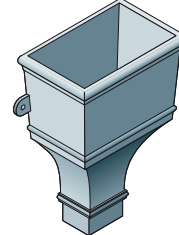

Ref HH/303

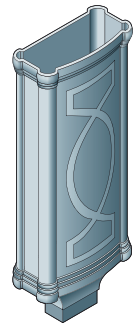

Ref HH/012

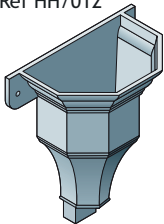

Ref HH/042

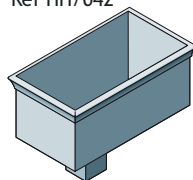

Ref HH/091

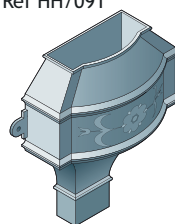

Ref HH/169

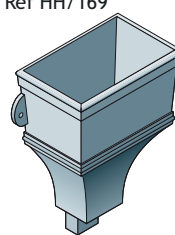

Ref HH/304

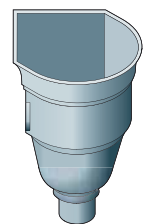

HH/017

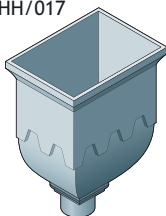

Ref HH/061

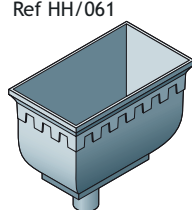

Ref HH/097

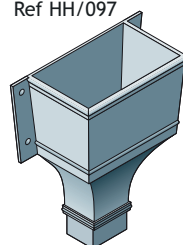

Ref HH/170

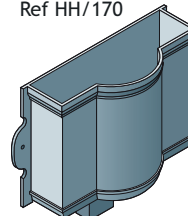

Ref HH/305 and 306

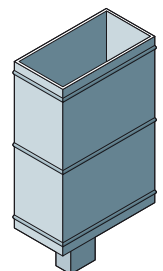

Ref HH/034

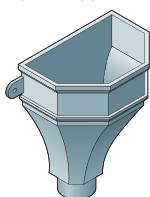

Ref HH/062

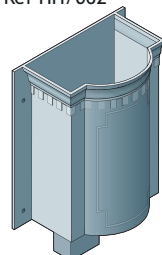

Ref HH/131

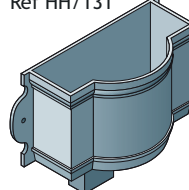

Ref HH/301

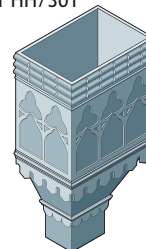

Apex Heritage - Made to Order Rainwater Heads



The number of available made-to-order designs increases as additional patterns are created for new commissions.

A variety of different designs is possible for decorative earbelts.

Additional enrichments can be incorporated into the rainwater heads shown.

Table Notes:

- 1 Overall width of rainwater head
- 2 Height of rainwater head excluding spigot

Made To Order Rainwater Heads

Outlet Sizes (mm) - up to		Width ¹	Height ²	Product Code
Circular	Square & Rectangular			
102 dia	127 x 102	444	368	HH/011
102 dia	102 x 102	356	305	HH/012
76 dia	N/A	267	260	HH/017
152 dia	152 x 102	451	380	HH/034
102 dia	102 x 102	2 shapes	305	HH/040
152 dia	152 x 102	3 sizes	152	HH/042
102 dia	127 x 102	457	165	HH/061
102 dia	127 x 102	476	610	HH/062
152 dia	152 x 102	3 sizes	229	HH/082
76 dia	76 x 76	356	343	HH/091
102 dia	102 x 102	2 shapes	292	HH/097
127 dia	127 x 102	476	210	HH/131
127 dia	127 x 102	381	406	HH/132
N/A	102 x 102	298	210	HH/169
102 dia	102 x 2	419	152	HH/170
N/A	76 x 76	250	381	HH/301
N/A	102 x 76	202	330	HH/303
102 dia	N/A	368	-	HH/304
N/A	102 x 76	317	451	HH/305
N/A	102 x 76	762	451	HH/306

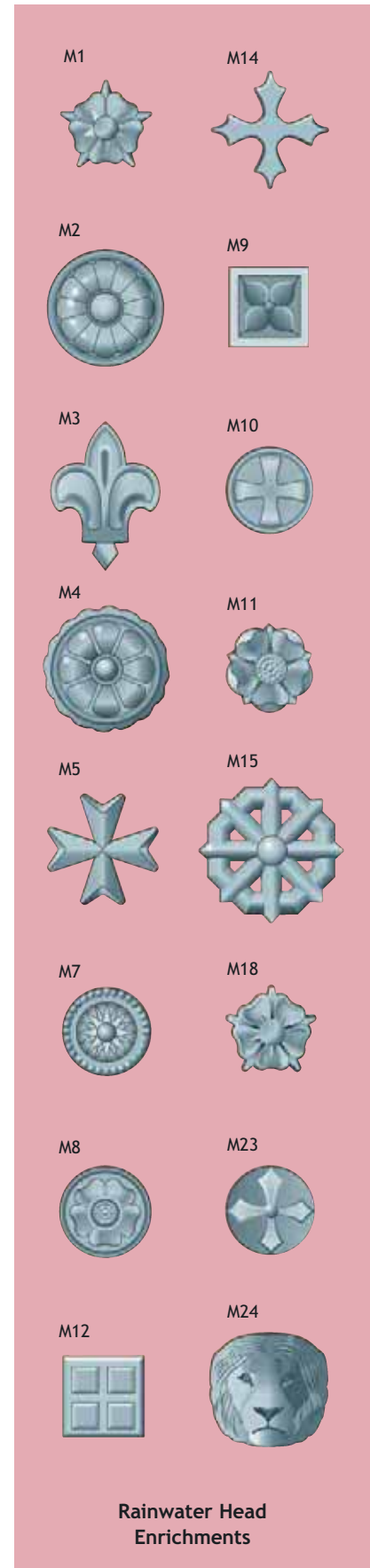

Apex Heritage - Made to Order Pipes and Holderbats

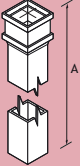

Made to Order Downpipes

	Pipe Size	A	Product Code
	102 x 76	1830	SP10
	102 x 76	1830	SP13

Note: All dimensions shown are in mm.

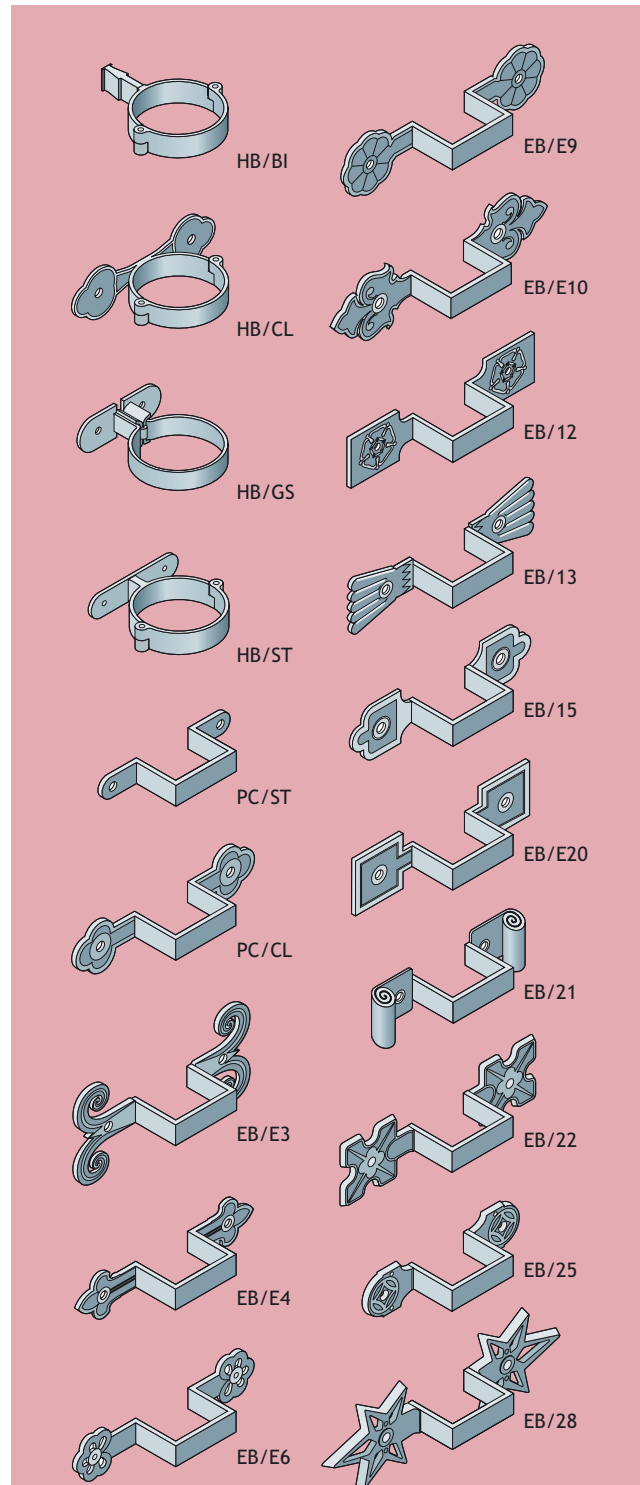

Note

Bracketry is available for all pipe sizes.
 Order codes should be prefixed by one of the following pipe types/sizes:
 Round Pipes: P25, P30, P40
 Square/Rectangular Pipes: P33, P43, P44, P54, P64
 For example, P33/EB/E6 –
 For the relevant pipe tables, see pages 139-141 (Round Pipes)
 and 143-149 (Square/Rectangular Pipes).
 Contact Alumasc for further information.

Alumasc Rainwater Systems Cast Iron Range Installation Procedures

Preparatory requirements and installation
methods for the
Apex Heritage gutter and pipe system.



Cast Iron Rainwater Installation - Introduction

For safe and satisfactory installation of Alumasc rainwater systems, the following good practice guidelines should be reviewed before installation commences. Where unusual or special conditions arise contact Alumasc Technical Services for assistance.

General Preparation and Good Practice

Securely fixed fascia boards must be painted and capable of supporting a fully loaded gutter. Check fascia for straightness and whether shims will be necessary to align brackets without creating stress at gutter joints. Where fascia boards are not being used Alumasc provide top and side fix rafter arm brackets as well as masonry drive-in brackets.

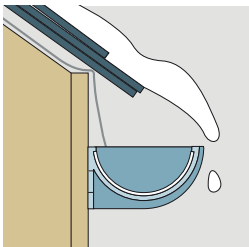

Fix brackets so as to position the gutter centrally and as close below the roof edge as possible, taking into consideration locality and roof slope finish.

If there is a risk of sliding snow, adjust the bracket positions to prevent snow hitting the front of the gutter. Extra fixings, brackets and snowboards should be considered where appropriate.

Where high winds are expected, a small bead of sealant must be applied between gutter and brackets a flexible adhesive. An occasional screw, fixed through a slot in the back of the gutter and into the fascia may be preferred, at a minimum of two per length.

Alumasc advise that the designer and contractor satisfy themselves that the application is suitable.

Setting Out

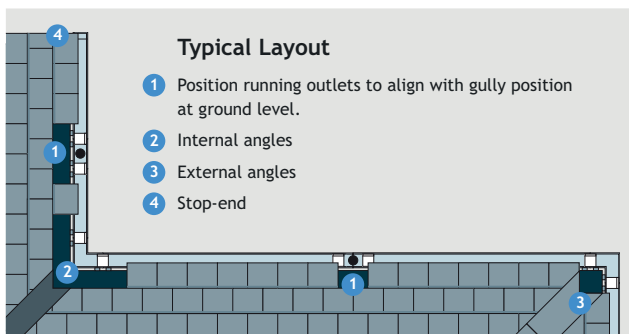

After setting out angles and outlets, fit gutters and brackets according to installation procedures for the specific rainwater system being used, as detailed in this brochure.

Cutting and Drilling

Cast iron can be cut and drilled on site with regular metalworking tools. Pencil cut lines and apply masking tape either side of cut line to protect against accidental saw damage.

Testing

Allow sufficient time for sealant joints to fully cure. Check all bracket and gutter fixings are secure and plug outlets. Fill up to overflow level (but not beyond). Allow 5 minutes before inspecting all joints for leaks.

Health and Safety

Always refer to current Health and Safety legislation, safe systems of work and the relevant material safety data sheets.

Factory-primed System Components

Alumasc supplies cast iron products factory primed with one coat of protective red oxide primer. This primer will give protection against corrosion during transportation and short-term undercover storage, and will provide a suitable surface for final painting. On-site handling and painting are the responsibility of the contractor, and particular environmental considerations should be taken into account when choosing the paint system for final finishing.

Further Protection on Site

Alumasc recommends that on site a further priming coat be applied, followed by 1 undercoat and 2 gloss coats of an alkyd paint system. All individual elements should receive the first of the gloss coats before fixing, and finished with the final gloss coat after the installation is complete. All exposed surfaces must be treated in this way. It is advisable to take the paint finish inside collars and within the ends of rainwater pipes to avoid the possibility of rust staining.

Care & Maintenance, Storage & Handling

Routine Inspection

Regularly clean out rainwater heads and gutters and ensure that downpipes are clear at all times. Check that joints and fixings are secure by periodic inspection, not less than twice a year, and preferably at the beginning of Autumn and again at the end of Winter. When inspecting an installation, even when well fixed, ladders should not be rested against the gutters.

Repainting

The final paint finish on factory-primed cast iron must be maintained to give the longest service life. A well applied paint system might be expected to last from 5 to 7 years on cast iron without further attention. Regular inspection is recommended.

It is recommended that pre-finished cast iron is maintained as above. It is important that any installation damage to the coating is repaired with the appropriate touch-up paint. Any cut pieces exposing bare metal must be coated with primer and top coat.

Other Maintenance Operations

When cleaning adjacent surfaces, cast iron should be protected against all acids and concentrated alkalis.

Storage and Handling

Pre-finished coated rainwater gutters and pipes must be handled with care to prevent scratches and dents. Materials should be stored on a level surface or racking, preferably under secure cover. Uneven fading or water marks on coated and mill finish surfaces may occur if water enters protective packing or goods are stored exposed to sunlight.

Primed goods will have manufacturing blemishes such as grinding and fettling marks, welding will be visible on fabricated items. It is recommended primed material is painted on-site.

Store seals and sealants under cover and make secure and separate provision for solvents. Dispose of packing materials responsibly.

Installation - Apex Heritage Gutters

Apex Heritage gutters are available in a choice of four profiles with a range of brackets to accommodate all types of eaves condition. Each profile range can be connected to cast iron pipework systems in either round, square or rectangular. Assembly and installation of each profile range must be considered individually, although general aspects of preparation are common to them all as shown below.

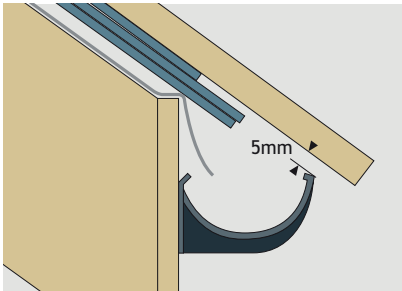

1. Using a straight edge or ruler, shim gutter brackets with 5mm clearance so that the last roof tile or slate will align with the mid point of the gutter.

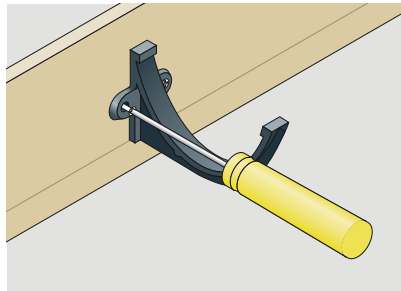

2. Generally, position brackets at 915mm centres allowing additional brackets on either side of where gutter joints will occur.

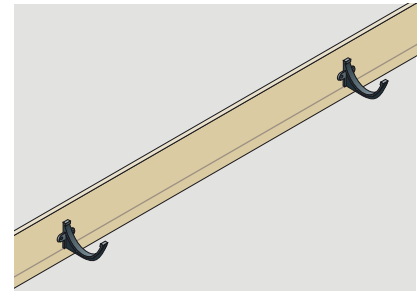

3. Use a string line to set out brackets to a fall of 1:600 to 1:350 (max) or if not possible, level.

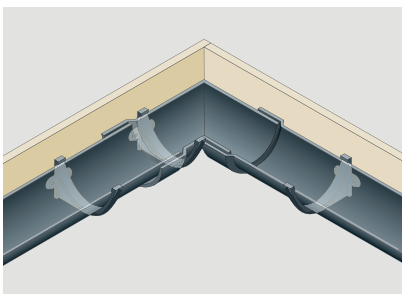

4. Plumb line outlets with gullies at ground level. Position angles, allowing an additional bracket adjacent to the joint with the gutter length.

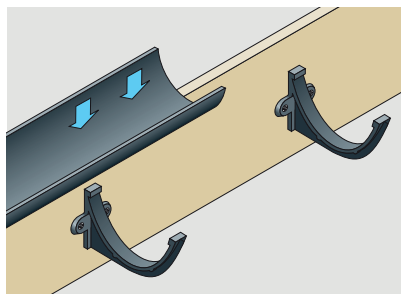

5. Lower the gutter onto the brackets ensuring sufficient clearance for the gutter joint. Clip gutter into bracket.

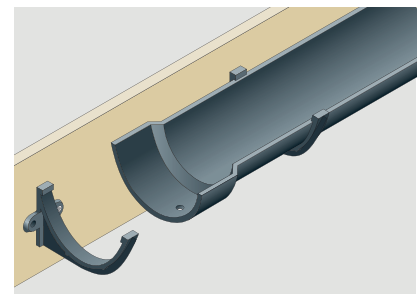

6. Cast gutters overlap at the joint with a spigot and socket. Thoroughly clean and degrease the ends that must be jointed.

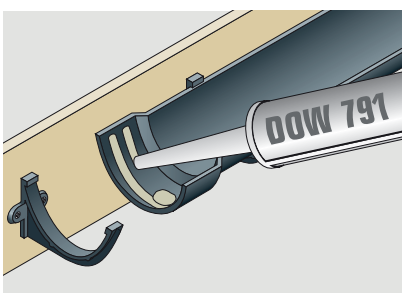

7. Apply two 6mm beads of DOW 791 silicone sealant either side of, and around the fixing hole.

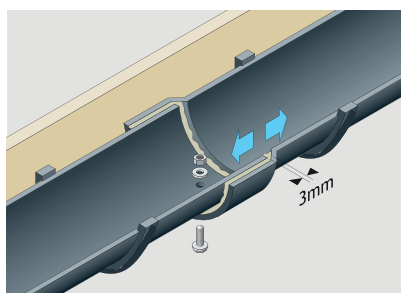

8. Insert the spigot end of the gutter allowing a 3mm expansion gap. Secure joint using bright zinc plated, mild steel M6 x 25mm nut, bolt and washer provided. (Bolt head preferably to underside).

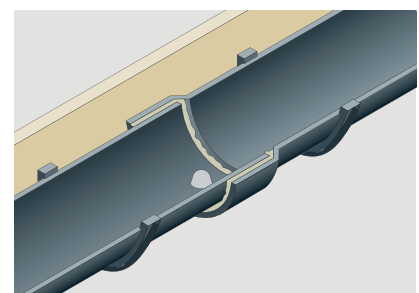

9. Finally, cone-off the exposed bolt stud and nut inside the gutter with a generous application of silicone sealant. Tool off excess silicone around the joint and from external surfaces.

Hydrostrip Alternative Sealing Method

For half round gutters only (nominal sizes 100, 115 and 125mm – 150mm), the unique Alumasc Hydrostrip system is recommended. The Hydrostrip system comprises preformed rubber seals that are quick and easy to install, and totally reliable. Hydrostrip offers a faster and cleaner solution to gutter jointing than traditional mastic jointing sealants.

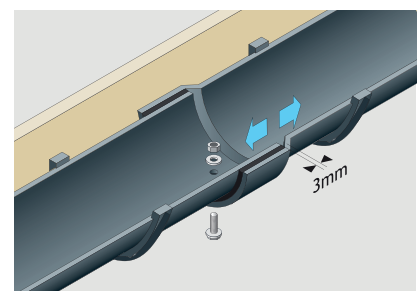
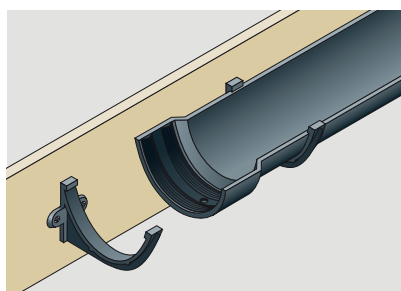

Installation - Apex Heritage Rainwater Pipes

Apex Heritage traditional rainwater pipes have cast pipe sockets either with ears for wall fixing or without for use with holderbats. Installation is generally from the eaves downward.

Saw cuts must be square and free from dents and burrs. A light application of silicone sealant must be applied to both surfaces to ensure a waterproof seal.

Pipe Alignment

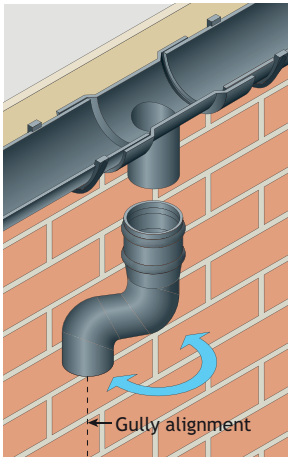

Where square or rectangular pipes are being installed and offsets are required, alignment between the gutter outlet and gully must be exact.

Round pipe systems are more flexible to install and offsets can be adjusted and “swung” into alignment with the gully position.

Outlets and Offsets

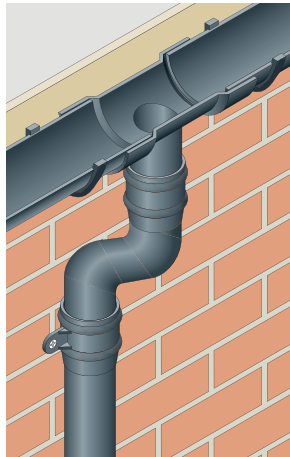

Commence installation from the gutter outlet by fitting offsets.

Check vertical plumb line positioning and seal spigot and socket joints using DOW 791 silicone sealant.

Pipe Jointing and Fixing

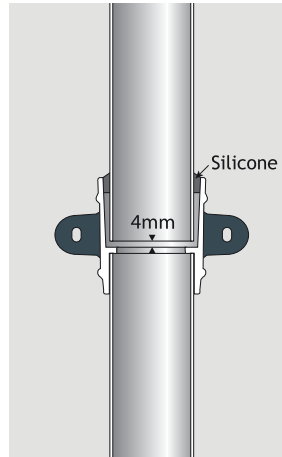

Seal with DOW 791 silicone sealant.

Fix to wall at 2m centres using No12 x 50mm screws. Eared sockets have elongated fixing holes to permit the use of pipe nails.

Tools Required

- String or plumb line
- Tape measure
- Drill
- File
- Masonry bit
- Wall fixing (e.g raw plug)
- Cleaning rags
- Marker pen
- Solvent cleaner
- Posi and plain screwdriver
- Paintbrush
- Hacksaw
- Masking tape
- Mastic gun
- Spirit level
- Protective gloves
- Adjustable spanner

General Installation Sequence

- Complete installation of gutters; alternatively, locate rainwater heads
- Position offsets, bends and branches
- Fit pipes and brackets
- Fit plinth offsets
- Fit access doors and shoes

Sealant

For durable all weather seals and best results, Alumasc recommend the use of DOW 791 silicone sealant.

Rainwater Heads

Fix to masonry through external lugs or preformed holes in back.

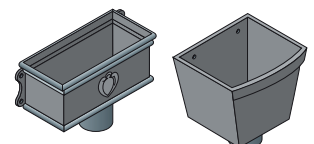

Bends and Branches

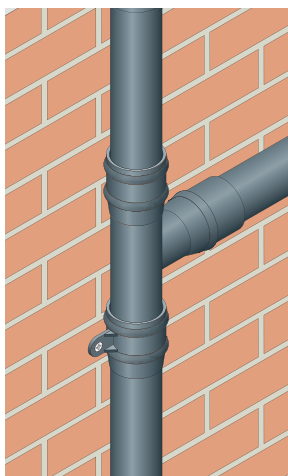

Bends and branches are secured into the pipe socket.

Shoes and Access Pipes

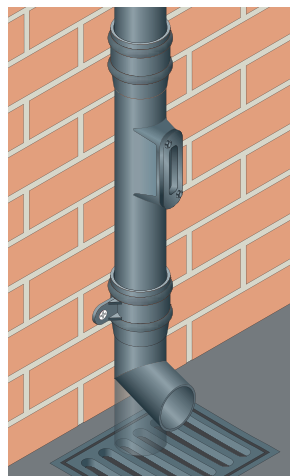

At ground level rainwater pipes can terminate with a shoe for free discharge over a gully or be directly connected into the gully.

In the case of direct connections it is recommended that an access pipe fitting is included within 750mm of ground level.

Alumasc Rainwater Systems Cast Iron Range Supplementary Information

Essential background information to ensure that an appropriate and correct cast iron rainwater system is installed.

Accessories

Touch Up Paint

RAL Code	Description	Size	Product Code
 RAL 3009	Oxide Red	125ml	TUPCI/RAL3009/125
 RAL 3020	Traffic Red	125ml	TUPCI/RAL3020/125
 RAL 5010	Flower Blue	125ml	TUPCI/RAL5010/125
 RAL 6005	Moss Green	125ml	TUPCI/RAL6005/125
 RAL 7016	Anthracite Grey	125ml	TUPCI/RAL7016/125
 RAL 8015	Chestnut Brown	125ml	TUPCI/RAL8015/125
 RAL 9005	Black	125ml	TUPCI/RAL9005/125
 RAL 9016	White	125ml	TUPCI/RAL9016/125

Note: The colours reproduced on this page are for general guidance only.

Hydrostrip Sealing System

The Hydrostrip system comprises preformed rubber sealing strips that are quick and easy to install.

Hydrostrip is supplied complete with screws, nuts and installation instructions in kits containing 20 jointing sets. Hydrostrip is not suited for use with Beaded Half Round gutters.

With Hydrostrip, joints can be made in damp conditions and can be overpainted immediately.

For half round gutters only.



Silicone Sealant

	Type	Colour	Size	Product Code
	Dow Corning 797	White	310ml Cartridge	SS991558
	Dow Corning 797	Grey	310ml Cartridge	SS991559
	Dow Corning 797	Bronze	310ml Cartridge	SS991560
	Dow Corning 797	Black	310ml Cartridge	SS991561
	Dow Corning 797	Limestone	310ml Cartridge	SS991562

Fixings

	Type	Size	Notes	Product Code
	Nut/Bolt/Washer	M6 x 25mm	Bright zinc plated mild steel	NBW 630310
	3" Pipe Nail	M8 x 75mm	Bright zinc plated mild steel	NAIL30
	4" Pipe Nail	M8 x 100mm	Bright zinc plated mild steel	NAIL40
	3" Coach Screw	M8 x 75mm	Hardened steel zinc plated	COACH30
	4" Coach Screw	M8 x 100mm	Hardened steel zinc plated	COACH40
	Coach Screw Cap	M8 dia	Black plastic	COACHCAP
	Countersunk woodscrew	No.12 x 1.5"	To fix rafter arms to GX Brackets	ZNBW969041
	Roundhead woodscrew	No.12 x 1.5" with Washer	To fix Apex Heritage Fascia Brackets or for 'direct fix' Gutter range	NBW 630362
	Roundhead woodscrew	No.12 x 2" with Washer	To fix pipe sockets with ears or pipe clips	NBW 630361

Rainwater System Design

Alumasc Technical Services is a fully experienced team of Rainwater specialists who use the latest CAD technology and calculation tools to provide an unrivalled support service to Architects, Designers and Contractors.

The Alumasc Rainwater Drainage Design Service

Alumasc Technical Services use dedicated design software in conjunction with the requirements of *BS EN 12056:2000: Gravity drainage systems inside buildings - Part 3* to calculate the most appropriate Alumasc rainwater system to suit project requirements.

The gutter flow software automatically checks the capacity of downpipes used and suggests the minimum size to which downpipes can be sized. Contact Alumasc for further information.

Sizing of Gutters and Downpipes

The level of rainfall a given roof drainage system should cope with is based on the position of the gutter, the potential use of the building and its projected lifespan. All true eaves gutters (external) are designed using a 1 year storm event. This is generally accepted because overflow from an external eaves gutter will fall clear of the building, which is not normally a problem. Any gutter which is classed internal, even if it is at the eaves, should be designed for an intensity based on the building life and a suitable factor of safety.

Step 1

Geographical Location and Rainfall Intensity Maps

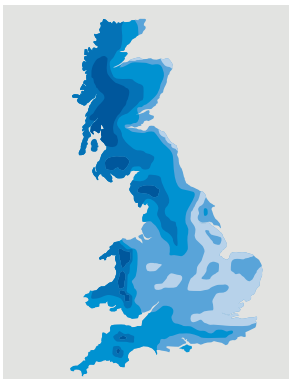

BS EN 12056-3: 2000 contains maps showing rainfall intensity in litres/second per m² for 1, 5, 50 and 500 year storms of 2 minute duration.

(All external gutters designed for 1 year event).

Step 2

Calculating Catchment Area

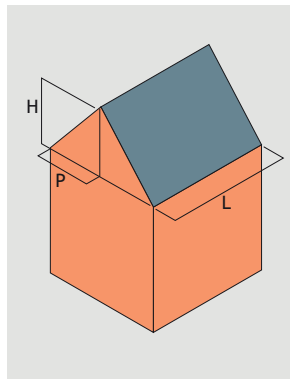

$$CA = (P+H/2) \times L$$

CA = Catchment area in square metres

P = Horizontal distance between eaves and ridge

H = Height of roof

L = Length of eaves

Calculation Criteria

Calculation of the most efficient drainage solution takes into consideration the following criteria:

- Catchment area
- Local rainfall intensity
- Building life and safety factor
- Size and flow rate of gutters
- Frequency and size of outlets and downpipes

This factor will vary from 1.5 for conventional buildings to 4.5 for very important structures. For most buildings a 60 year life and safety factor of 1.5 would be the most suitable (90 year protection life).

All the parameters of flow calculations cannot be captured using a single formula. The guide below provides a basic method for calculating flow requirements. For accurate project specific specification advice on rainwater flow calculations contact Alumasc Technical Services.

Step 3

Frequency and Positioning of Outlets/Downpipes

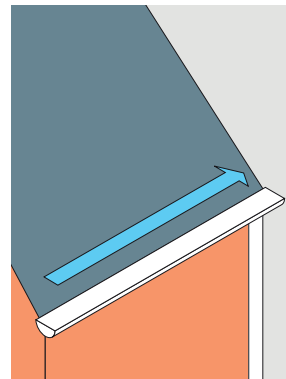

Calculate the number of outlets per run.

Step 4

Calculate Flow Requirements

Overall Rainfall

Catchment Area (CA) x Rainfall Intensity (RI) = Overall Rainfall (OR)

Flow Rate Per Outlet

Overall Rainfall (OR) ÷ Number of Outlets = Flow Rate Per Outlet

Choose Gutter/Outlets according to published Flow Rate capacities.

Note:

Depending on building type, a safety factor should be allowed for the sizing of internal gutters. Contact Alumasc Technical Services for further information.



Technical Support

Alumasc's new Drainage Design Calculators are available as a download from the Alumasc Rainwater website.

www.alumascrainwater.co.uk

Gutter Flow Rates

All Flow Rates quoted on this page are shown in litres per second. Gutter capacities are based on BS EN 12056-3:2000, assuming a maximum distance of 50 x gutter depth, from high point to outlet. Longer gutters or gutters with corners exceeding 10° will have a reduced capacity.

For further information contact Alumasc Technical Services.

Rainwater Gutter Flow Rates (l/s)

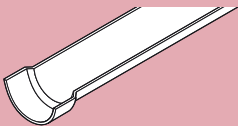
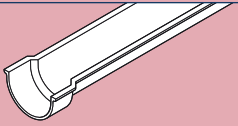
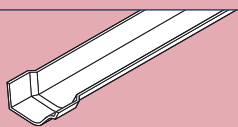
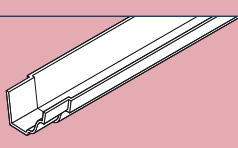
	Profile	Size (mm)	Pipe outlet Diameter (mm)			Pipe outlet size (mm)		
			63	75	100	75 x 75	100 x 75	100 x 100
	Half Round	100	1.19	1.22	-	-	-	-
		113	1.19	1.62	-	-	-	-
		125	1.19	1.62	2.06	-	-	-
		152	1.19	1.64	3.14	-	-	-
	Beaded Half Round	113	1.19	1.62	-	-	-	-
		125	1.19	1.97	2.06	-	-	-
	Victorian Ogee	113	1.24	1.80	-	-	-	-
		125	1.24	1.97	2.32	-	-	-
	Moulded	100 x 75	1.09	1.64	-	2.24	2.24	-
		125 x 100	1.09	1.64	3.21	2.17	3.17	-
		150 x 100	1.09	1.64	3.21	2.17	3.17	4.43

Rainwater Pipe Flow Rates

Note: The capacity of a rainwater system is usually dependent upon the capacity of the gutter outlet or flat roof outlet rather than the rainwater pipe. Please refer to BS EN 12056-3:2000, Section 6, Table 8 for capacities of vertical rainwater pipes.

A typical NBS Specification for Alumasc cast iron gutters and downpipes is provided below. A full range of NBS specifications are available via Alumasc's online NBS Specification Builder at www.alumascrainwater.co.uk. For project specific specification advice, contact Alumasc Technical Services.



R10 Rainwater Drainage Systems

GENERAL

- Gravity Rainwater Drainage System.
- Rainwater outlets, gutters, pipework and accessories as per detail sections below.

SYSTEM PERFORMANCE

- Design Standard: To BS EN 12056-3:2000, clauses 3-7 and National Annexes.
- Collection and Distribution of Rainwater: Complete, and without leakage or noise nuisance.
- Design Parameters: Design rate of rainfall as per BS EN 12056-3:2000, National Annex NB.2 - Category 1

PRODUCTS (TYPICAL SPECIFICATION)

APEX HERITAGE CAST IRON HALF ROUND BEADED GUTTER (113mm)

315 APEX HERITAGE CAST IRON GUTTERS

Gutters and fittings to: BS 8530 (formerly BS 2997)
 Manufacturer: Alumasc Exterior Building Products Ltd
 White House Works, Bold Road, Sutton, St Helens, Merseyside WA9 4JG.
 Tel: 01744 648400, Fax: 01744 648401, Email: info@alumasc-exteriors.co.uk

Reference: Apex Heritage cast iron rainwater system
 Profile: Half Round Beaded
 Size: 113mm
 Outlet Size: 75mm
 Type/grade: Made from LM2 and LM6 grades of Aluminium alloy to BSEN1559:1997, BSEN 1676:1997 and BSEN 1706:1998
 Finish: Painted Finish
 Colour: RAL 3020 233 Traffic Red

Jointing: Gutter lengths or fittings are overlapped at the joint with a spigot and socket. Slots are provided for fixing using M6 mushroom head aluminium screws with nuts and washers. Seal evenly across the joints with Dow Corning 791.

Fixing: Fascia bracket fixed at 915mm centres and at each fitting using number 12x38mm round head twin thread screws and washers bright zinc plated.

PRODUCTS (TYPICAL SPECIFICATION)

APEX HERITAGE CAST IRON DOWNPIPE (75mm diameter)

380 APEX HERITAGE CAST IRON PIPEWORK FOR EXTERNAL USE:

Pipes, fittings and accessories to: BS 2997
 Manufacturer: As above

Reference: Apex Heritage cast iron downpipe system
 Size: 75mm diameter
 Type/grade: 6063 TF alloy
 Finish: Painted Finish
 Colour: RAL 3020 233 Traffic Red

Fixing: Pipe clip fixed at maximum 2.0m centres. Plug and screw to wall with number 12 x 50mm round head twin thread screws and washers bright zinc plated to BS 1706:1960 Class ZN3. Seal internal spigot joints with Dow Corning 791 silicone sealant allowing for a 3-4 mm vertical thermal movement gap.

Accessories: Bends, Branches, Access Pipes, Offsets, Shoes, Rainwater Heads, Pipe Clips



Create Alumasc Rainwater System NBS specifications by selecting the required product range, profile, size and finish by visiting:
www.alumascrainwater.co.uk

General Specification Advice

General specification clauses for aluminium rainwater systems are provided below.

For project specific specification advice, contact Alumasc Technical Services.

EXECUTION CLAUSES

600 PREPARATION, ENSURE:

- Below ground drainage is ready to receive rainwater or that the discharge can be dispersed by approved means to prevent damage or disfigurement of the building fabric.
- Any specified painting of surfaces which will be concealed or inaccessible is completed.

605 INSTALLATION GENERALLY:

- Install pipework/gutters to ensure the complete discharge of rainwater from the building without leaking.
- Obtain all components for each type of pipework/guttering from the same manufacturer unless specified otherwise.
- Provide access fittings and rodding eyes as necessary in convenient locations to permit adequate cleaning and testing of pipework.
- Avoid contact between dissimilar metals and other materials which would result in electrolytic corrosion.
- Do not bend plastics or galvanized steel pipes.
- Adequately protect pipework/gutters from damage and distortion during construction. Fit purpose made temporary caps to prevent ingress of debris. Fit all access covers, cleaning eyes and blanking plates as the work proceeds.
- Where not specified otherwise use plated, sherardized, galvanized or nonferrous fastenings, suitable for the purpose and background, and compatible with the material being fixed.

610 FIXING AND JOINTING GUTTERS:

- Fix securely at specified centres and at all joints in gutters, with additional brackets near angles and outlets.
- Provide for thermal and building movement when fixing and jointing, and ensure that clearances are not reduced as fixing proceeds.
- Seal as specified to make watertight.
- Spread jointing compound evenly over jointing face of socket.
- For gutters with bolted joints, tighten joints in the gutter sole before any other bolts. Fit suitable washers, and spacers to prevent overtightening, unless specified otherwise.
- Tighten fixing to squeeze out some compound.
- Remove surplus, squeezed out compound and neatly clean off.
- Ensure that roofing underlay is dressed into gutter.

615 SETTING OUT EAVES GUTTERS - TO FALLS

- Set out to a true line and even gradient to ensure no ponding or backfall. Position high points of gutters as close as practical to the roof and low points not more than 50 mm below the roof.
- Position outlets to align with connections to below ground drainage, unless shown otherwise on drawings.

630 RAINWATER OUTLETS, ENSURE THAT:

- Outlets are securely fixed before connecting pipework.
- Junctions between outlets and pipework can accommodate all movement in the structure and pipework.

435 FIXING PIPEWORK:

- Fix securely at specified centres plumb and/or true to line.
- Make changes in direction of pipe runs only where shown on drawings unless otherwise approved.
- Fix branches and low gradient sections with uniform and adequate falls to drain efficiently.
- Fix externally socketed pipes/fittings with sockets facing upstream.
- Provide additional supports as necessary to support junctions and changes in direction.
- Fix every length of pipe at or close below the socket collar or coupling.
- Provide a load bearing support for vertical pipes at not less than every storey level. Tighten fixings as the work proceeds so that every storey is self supporting and undue weight is not imposed on fixings at the base of the pipe.
- Isolate from structure where passing through walls or floors and sleeve pipes as specified in Section P31.
- Provide for thermal and building movement when fixing and jointing, and ensure that clearances are not reduced as fixing proceeds.
- Fix expansion joint pipe sockets rigidly to the building and elsewhere use fixings that allow the pipe to slide.

650 JOINTING PIPEWORK/GUTTERS:

- Joint using materials, fittings and techniques which will make effective and durable connections.
- Joint differing pipework/gutter systems with adaptors recommended by manufacturer(s).
- Cut ends of pipes to be clean and square with burrs and swarf removed. Chamfer pipe ends before inserting into ring seal sockets.
- Ensure that jointing or mating surfaces are clean, and where necessary lubricated, immediately before assembly.
- Form junctions using fittings intended for the purpose ensuring that jointing material does not project into bore of pipes, fittings and appliances.
- Remove surplus flux/solvent/cement/sealant from joints.

675 COATED PIPEWORK/GUTTERS:

- Make good to coatings after cutting and any other damage or recoat, as recommended by the manufacturer.

685 IDENTIFICATION OF INTERNAL RAINWATER PIPEWORK:

- To BS 1710 using self-adhesive bands or identification clips located at junctions, at both sides of each slab, bulkhead and wall penetration, and elsewhere as directed.

690 ELECTRICAL CONTINUITY:

- Use clips or suitable standard couplings supplied for the purpose by pipework manufacturer to ensure electrical continuity at all joints in metal pipes with flexible couplings and which are to be earth bonded.

700 ACCESS FOR TESTING AND MAINTENANCE:

- Install pipework and gutters with adequate clearance to permit testing, cleaning and maintenance.
- Position access fittings and rodding eyes so that they are not obstructed by other pipework, framing, etc.

COMPLETION CLAUSES

900 TESTING GENERALLY:

- Inform the Contractor Administrator sufficiently in advance to give him a reasonable opportunity to observe tests.
- Check that all sections of installation are free from obstruction and debris before testing.
- Provide clean water, assistance and apparatus for testing as required.
- Carry out tests as specified. After testing, locate and remedy all defects without delay and retest as instructed.
- Keep a record of all tests and provide a copy of each to the Contractor Administrator.

905 INTERNAL PIPEWORK TEST - ENGLAND, WALES AND NORTHERN IRELAND:

- Temporarily seal open ends of pipework with plugs.
- Connect a 'U' tube water gauge and air pump to the pipework via a plug.
- Pump air into pipework until gauge registers 38 mm.
- Allow a period for temperature stabilization, after which the pressure of 38 mm is to be maintained without loss for not less than 3 minutes.

906 INTERNAL PIPEWORK TEST- SCOTLAND

- Standard - To BSEN12056-3:2000, National Annex NG

910 GUTTER TEST:

- Block all outlets, fill gutters to overflow level and after 5 minutes closely inspect for leakage.

915 MAINTENANCE INSTRUCTIONS

- At completion, submit printed instructions recommending procedures for maintenance of the rainwater installation including full details of the recommended inspection, cleaning and repair procedures.

920 IMMEDIATELY BEFORE HANDOVER:

- Remove construction rubbish and debris from all roofs and gutters. Where possible, sweep and remove fine dust which may enter rainwater systems. Do not sweep or flush dust or debris into the rainwater system.
- Remove swarf, debris and temporary caps from the entire rainwater installation.
- Ensure that all access covers, rodding eyes, outlet gratings, etc. are secured complete with all fixings.

Harmer LCC Cast Iron Soil & Waste Systems

A traditional cast iron system of socketed pipes, fittings and accessories, manufactured to imperial dimensions and created to faithfully reproduce period detail.



Harmer LCC Traditional Cast Iron Soil & Waste Systems - Product Summary



Harmer - LCC Pipes



Harmer - LCC Couplings



Harmer - LCC Double Branches



Harmer - LCC Holderbats



Harmer - LCC Single Branches



Harmer - LCC Bends

Pipes and Fittings

The pipes, branches and bends illustrated above are available in various sizes and configurations, including options for access.

Other fittings include Blank Ends, Socket Reducers, Diminishing Pieces, Swan Necks, Boss Pipes, Shoes and P Traps.

Harmer LCC Traditional Cast Iron Soil & Waste Systems Product Summary

Alumasc has taken the original processes for the casting of iron, and combined them with modern manufacturing techniques to produce a product fully attuned to today's refurbishment requirements.

Features

Harmer LCC incorporates all the inherent characteristics of cast iron, plus dimensional accuracy and a consistent standard of finish for the final site installation.

An extensive range of fittings and accessories provides great flexibility in installation, while special detailing requirements can be catered for through Alumasc's fabrication and pattern making workshops.

Alumasc has also perfected the welding of cast iron, so that fittings or offsets to suit a particular situation can be specially fabricated where the alternative of making a pattern would not be economic.

Key Benefits

- Ideal for itemised replacement of existing LCC systems
- Manufactured to original imperial dimensions
- Supplied ready painted
- Comprehensive range of fittings
- Unique specials manufacture and fabrication

General Description

Finishes

Harmer LCC soil and waste pipes and fittings are factory-dipped in bitumen in accordance with BS 416. Where gloss painting is required, it is advisable to contact Alumasc Technical Services on 01744 648400.

Standards

Harmer LCC waste pipes and fittings comply with the requirements of BS 416: Discharge, ventilating pipes and fittings, sand cast or spun in cast iron, Part 1, 1990. Harmer LCC systems also comply with the relevant sections of the Building Regulations throughout the United Kingdom.

Installation

BS 8000: Workmanship on building sites, Part 13, Code of practice for above ground drainage and sanitary appliances, 1989 is applicable.

Suitability

Cast iron should not be used for conveying acid wastes or laid unprotected in any soil conditions where corrosion could occur.

On-site Storage

To avoid accidental damage to collars or pipe ends, pipes should be stored horizontally, blocked up clear of the ground and preferably under cover.

Imperial Dimensions

All products are made to the original imperial dimensions. This ensures a compatible interchange between old and new pipes and fittings and makes it more likely that, where an existing installation is being repaired or replaced, the original fixing holes can be re-used.

Pipe Fixing and Support

Holderbats for plugging and screwing to walls are available. Bobbins should be used to pack out the holderbat to give a 32mm painting gap for pipes up to 75mm (3") diameter, and 38mm for the 88mm (3 1/2") and 100mm (4") diameter pipes. For fixing centres reference should be made to BS 8000: Maximum distance between sanitary pipe supports, Table 1.

Pipe Joints

Pipe joints should be made using a caulking of 6mm diameter yarn, now available only in glass fibre instead of the traditional tarred yarn, with a minimum 38mm thickness of lead wool, well compacted.

Testing

The Building Regulations 1991, Requirement H1, Approved Document paragraph 1.7(a) requires that all the pipes, fittings and joints should be capable of withstanding an air or smoke test of at least 38mm gauge, for 3 minutes.



Harmer LCC Pipes

Pipe Diameters, Lengths and Weights: Manufacturing Dimensions

		100	88	76	63	50	
	Single Socket	Pipe diameter	100	88	76	63	50
	A Internal diameter	100	85	76	60	50	
	B External diameter	114	100	88	76	63	
	C Thickness	6	6	6	6	6	
	D Diameter over spigot bead	104	111	98	85	69	
	Socket						
	E Internal diameter	127	114	100	88	73	
	F External diameter	136	130	117	104	88	
	G Thickness	6	6	6	6	6	
	H Internal depth	76	76	69	69	63	
	I External diameter over spigot bead	133	146	139	114	100	
	J Caulking clearance	6	6	6	6	6	
	Ears						
K Length of flange overall	212	193	177	161	146		
L Centre to centre of holes	180	161	146	130	114		
Double Socket (1830mm pipe length only)							
Pipe length and weight		100	88	76	63	50	
1830 (6') overall length of pipe		1830	1830	1830	1830	1830	
Effective length of pipe		1725	1725	1730	1730	1737	
Weight of 6' pipe without ears		21.7 kg	19.0 kg	16.7 kg	14.0 kg	11.0 kg	
Weight of 6' pipe with ears		22.2 kg	19.5 kg	17.2 kg	14.5 kg	12.0 kg	
1219 (4') overall length of pipe		1219	1219	1219	1219	1219	
Effective length of pipe		1125	1125	1130	1130	1137	
Weight of 6' pipe without ears		14.5 kg	12.7 kg	11.2 kg	9.5 kg	8 kg	
Weight of 6' pipe with ears		14.8 kg	13 kg	11.5 kg	10 kg	8.5 kg	
914 (3') overall length of pipe		914	914	914	914	914	
Effective length of pipe		725	725	730	730	737	
Weight of 6' pipe without ears		10.8 kg	9.5 kg	8.3 kg	7 kg	5.7 kg	
Weight of 6' pipe with ears		11.3 kg	10 kg	8.8 kg	7.5 kg	6.2 kg	
610 (2') overall length of pipe		610	610	610	610	610	
Effective length of pipe		525	525	530	530	537	
Weight of 6' pipe without ears		7.3 kg	6.8 kg	5.5 kg	4.7 kg	4 kg	
Weight of 6' pipe with ears		7.8 kg	6.8 kg	6 kg	5.2 kg	4.5 kg	
Double socket pipe, 1830 (6') overall pipe length only							
Effective length of pipe		1650	1650	1663	1663	1669	
Weight of 6' pipe without ears		23.7 kg	20.5 kg	18.2 kg	15.3 kg	12.5 kg	
Weight of 6' pipe with ears		24.2 kg	21 kg	18.7 kg	15.8 kg	13 kg	
Note: Double socket pipes are subject to availability							

Note: All dimensions are given in millimetres. An imperial to metric conversion table is given on page 183.

Harmer LCC Pipes

Pipes - With and Without Ears

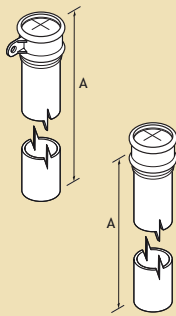
	Pipe Size	A	Product Code
		50 dia	610mm
	50 dia	914mm	L20/3FT
	50 dia	1219mm	L20/4FT
	50 dia	1830mm	L20/6FT
	63 dia	610mm	L25/2FT
	63 dia	914mm	L25/3FT
	63 dia	1219mm	L25/4FT
	63 dia	1830mm	L25/6FT
	75 dia	610mm	L30/2FT
	75 dia	914mm	L30/3FT
	75 dia	1219mm	L30/4FT
	75 dia	1830mm	L30/6FT
	87 dia	610mm	L35/2FT
	87 dia	914mm	L35/3FT
	87 dia	1219mm	L35/4FT
	87 dia	1830mm	L35/6FT
	100 dia	610mm	L40/2FT
	100 dia	914mm	L40/3FT
	100 dia	1219mm	L40/4FT
	100 dia	1830mm	L40/6FT

Notes: 1. Pipes without Ears. If pipes without ears are required, add suffix NE to the order code.
 2. Double Collared Pipes. If double collared pipes are required with ears, add suffix DCE to the order code. Add suffix DC if no ears required. Only available in 6ft lengths.
 3. Pipe nails are available to order.
 4. When specifying loose couplings, slip couplings and access pipes with ears, quote the full product code suffixed with /E.

Access Pipes

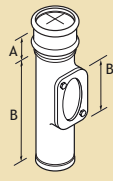
	Pipe Size	A	B	C	Product Code
		50 dia	63	234	63
	63 dia	69	245	76	L25/AP
	75 dia	69	266	88	L30/AP
	87 dia	76	273	95	L35/AP
	100 dia	76	285	100	L40/AP

Boss Pipes

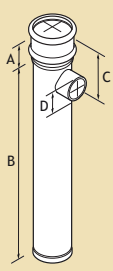
	Pipe Size	A	B	C	Inlet Pipe Size (D)	Product Code
		75 dia	76	381	139	38
	87 dia	76	381	139	38	L35/BP/150
	100 dia	76	381	139	31	L40/BP/125
	100 dia	76	381	139	38	L40/BP/150
	100 dia	76	381	139	50	L40/BP/200

Note: All dimensions are given in millimetres. An imperial to metric conversion table is given on page 183.

Harmer LCC Fittings

Screw To Wall Cast Iron Holderbats

	Pipe Size	Product Code
	50 dia	L20/HB/ST
	63 dia	L25/HB/ST
	75 dia	L30/HB/ST
	88 dia	L35/HB/ST
	100 dia	L40/HB/ST
Note: Cast iron bobbins are available spacing from 13mm to 50mm in 6mm increments.		

Built-in Holderbats

	Pipe Size	Product Code
	50 dia	L20/HB/BI
	63 dia	L25/HB/BI
	75 dia	L30/HB/BI
	88 dia	L35/HB/BI
	100 dia	L40/HB/BI
Note: Cast bobs are available spacing from 13mm to 50mm in 6mm increments.		

Loose Couplings

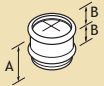
	Pipe Size	A	B	Product Code
	50 dia	45	95	L20/SOC
	63 dia	45	95	L25/SOC
	75 dia	38	90	L30/SOC
	87 dia	38	86	L35/SOC
	100 dia	35	80	L40/SOC

Slip Couplings

	Pipe Size	A	Product Code
	50 dia	95	L20/SOC/S
	63 dia	95	L25/SOC/S
	75 dia	89	L30/SOC/S
	87 dia	95	L35/SOC/S
	100 dia	79	L40/SOC/S

Note: When specifying fittings with ears, quote the full product code suffixed with /E.

Harmer LCC Fittings

Blank End

	Pipe Size	A	Product Code
	75 dia	76	L30/BE
	87 dia	76	L35/BE
	100 dia	70	L40/BE

Socket Reducer

	Pipe Size	A	B	Product Code
	75 dia	51	76	L30/SR/20
	87 dia	76	76	L40/SR/20
	100 dia	51	70	L40/SR/30

92.5° Bends

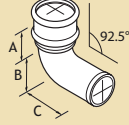
	Pipe Size	A	B	C	Product Code
	50 dia	152	139	88	L20/B/92
	63 dia	165	155	95	L25/B/92
	75 dia	174	161	104	L30/B/92
	87 dia	187	177	111	L35/B/92
	100 dia	193	180	117	L40/B/92

92.5° Bends with heel access

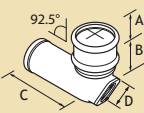
	Pipe Size	A	B	C	D	Product Code
	50 dia	152	139	88	63	L20/B/92
	63 dia	165	155	95	76	L25/B/92
	75 dia	174	161	104	88	L30/B/92
	87 dia	187	177	111	95	L35/B/92
	100 dia	193	180	117	100	L40/B/92

92.5° Long Radius Bends

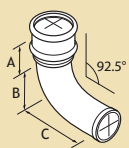
	Pipe Size	A	B	C	Product Code
	100 dia	298	304	222	L40/BLR

Note: If bends with ears are required, add LE to the order code for left hand side and RE for right hand side bend.

Harmer LCC Fittings

112.5° Bends

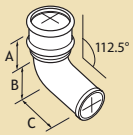
	Pipe Size	A	B	C	Product Code
	50 dia	152	139	88	L20/B/112
	63 dia	165	155	95	L25/B/112
	75 dia	174	161	104	L30/B/112
	87 dia	184	177	111	L35/B/112
	100 dia	193	180	120	L40/B/112

112.5° Bends with heel access

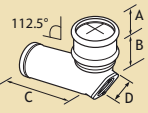
	Pipe Size	A	B	C	D	Product Code
	50 dia	152	139	88	63	L20/B/112H
	63 dia	165	155	95	66	L25/B/112H
	75 dia	174	161	104	73	L30/B/112H
	87 dia	184	177	111	95	L35/B/112H
	100 dia	193	180	120	100	L40/B/112H

135° Bends

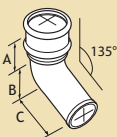
	Pipe Size	A	B	C	Product Code
	50 dia	127	142	88	L20/B/135
	63 dia	136	158	95	L25/B/135
	75 dia	142	161	104	L30/B/135
	87 dia	171	161	111	L35/B/135
	100 dia	177	165	120	L40/B/135

135° Bends with heel access

	Pipe Size	A	B	C	D	Product Code
	50 dia	127	142	88	63	L20/B/135H
	63 dia	136	158	95	66	L25/B/135H
	75 dia	142	161	104	73	L30/B/135H
	87 dia	171	161	111	95	L35/B/135H
	100 dia	177	165	120	100	L40/B/135H

Diminishing Pieces

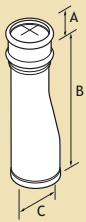
	Pipe Size	A	B	C	Product Code
	75 dia	69	304	50	L25/B/92AR
	100 dia	76	304	50	L25/B/92AL
	100 dia	76	304	75	L35/B/92AL

Note: If bends with ears are required, add LE to the order code for left hand side and RE for right hand side bend.

Harmer LCC Fittings

112.5° Swan Necks

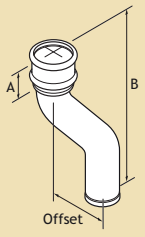

Pipe Size	A	B	Offset	Product Code
50 dia	63	241	75	L20/OF/03
50 dia	63	257	112	L20/OF/04
50 dia	63	273	150	L20/OF/06
50 dia	63	304	237	L20/OF/09
50 dia	63	336	300	L20/OF/12
50 dia	63	361	375	L20/OF/15
50 dia	63	400	475	L20/OF/18
50 dia	63	431	554	L20/OF/21
50 dia	63	463	600	L20/OF/24
63 dia	69	257	75	L25/OF/03
63 dia	69	273	112	L25/OF/04
63 dia	69	288	150	L25/OF/06
63 dia	69	320	237	L25/OF/09
63 dia	69	352	300	L25/OF/12
63 dia	69	384	375	L25/OF/15
63 dia	69	415	475	L25/OF/18
63 dia	69	447	554	L25/OF/21
63 dia	69	479	600	L25/OF/24
75 dia	69	266	75	L30/OF/03
75 dia	69	282	112	L30/OF/04
75 dia	69	298	150	L30/OF/06
75 dia	69	330	237	L30/OF/09
75 dia	69	361	300	L30/OF/12
75 dia	69	393	375	L30/OF/15
75 dia	69	425	475	L30/OF/18
75 dia	69	457	554	L30/OF/21
75 dia	69	488	600	L30/OF/24
87 dia	76	282	75	L35/OF/03
87 dia	76	298	112	L35/OF/04
87 dia	76	314	150	L35/OF/06
87 dia	76	346	237	L35/OF/09
87 dia	76	377	300	L35/OF/12
87 dia	76	409	375	L35/OF/15
87 dia	76	441	475	L35/OF/18
87 dia	76	473	554	L35/OF/21
87 dia	76	504	600	L35/OF/24
100 dia	76	288	75	L40/OF/03
100 dia	76	307	112	L40/OF/04
100 dia	76	323	150	L40/OF/06
100 dia	76	355	237	L40/OF/09
100 dia	76	387	300	L40/OF/12
100 dia	76	419	375	L40/OF/15
100 dia	76	450	475	L40/OF/18
100 dia	76	482	554	L40/OF/21
100 dia	76	514	600	L40/OF/24

Note: If swan necks with ears are required, add LE to the order code for left hand side and RE for right hand side bend.

Harmer LCC Fittings

92.5° Equal Single Branches

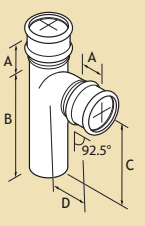
	Pipe Size	A	B	C	D	Product Code
	50 dia	63	234	177	88	L20/BR/9
63 dia	69	260	196	95	L25/BR/9	
75 dia	69	285	212	111	L30/BR/9	
87 dia	76	304	225	117	L35/BR/9	
100 dia	76	330	214	130	L40/BR/9	

92.5° Equal Single Branches with access

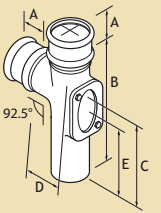
	Pipe Size	A	B	C	D	E	Product Code
	50 dia	63	234	177	88	146	L20/BRA/9
63 dia	69	260	196	95	161	L25/BRA/9	
75 dia	69	285	212	111	177	L30/BRA/9	
87 dia	76	304	225	117	190	L35/BRA/9	
100 dia	76	330	214	130	206	L40/BRA/9	

112.5° Equal Single Branches

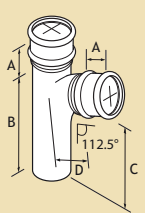
	Pipe Size	A	B	C	D	Product Code
	50 dia	63	234	155	79	L20/BR/11
63 dia	69	260	174	85	L25/BR/11	
75 dia	69	285	184	100	L30/BR/11	
87 dia	76	304	120	107	L35/BR/11	
100 dia	76	330	184	146	L40/BR/11	

112.5° Equal Single Branches with access

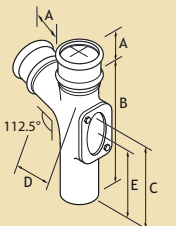
	Pipe Size	A	B	C	D	E	Product Code
	50 dia	63	234	155	88	146	L20/BRA/9
63 dia	69	260	174	95	161	L25/BRA/9	
75 dia	69	285	184	111	177	L30/BRA/9	
87 dia	76	304	120	117	190	L35/BRA/9	
100 dia	76	330	184	130	206	L40/BRA/9	

Note: When specifying fittings with ears, quote the full product code suffixed with /E.

Harmer LCC Fittings

135° Equal Single Branches

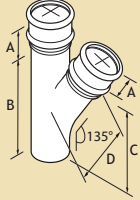
	Pipe Size	A	B	C	D	Product Code
	50 dia	63	234	120	114	L20/BR/13
	63 dia	69	260	130	130	L25/BR/13
	75 dia	69	285	133	152	L30/BR/13
	87 dia	76	304	146	158	L35/BR/13
	100 dia	76	330	146	184	L40/BR/13

135° Equal Single Branches with Access

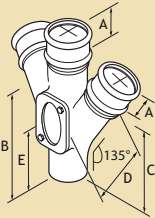
	Pipe Size	A	B	C	D	E	Product Code
	50 dia	63	234	120	114	146	L20/BRA/9
	63 dia	69	260	130	130	161	L25/BRA/9
	75 dia	69	285	133	152	177	L30/BRA/9
	87 dia	76	304	146	158	190	L35/BRA/9
	100 dia	76	330	146	184	206	L40/BRA/9

92.5° Unequal Single Branches

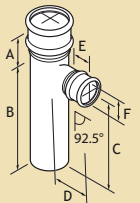
	Pipe Size	A	B	C	D	E	F	Product Code
	63 dia	69	260	196	95	63	50	L25/BRU/95
	75 dia	69	260	196	100	63	50	L30/BRU/95
	75 dia	69	273	206	104	69	63	L30/BRU/96
	87 dia	76	266	206	107	63	50	L35/BRU/95
	87 dia	76	285	209	111	69	63	L35/BRU/96
	87 dia	76	292	215	117	69	75	L35/BRU/97
	100 dia	76	279	219	114	63	50	L40/BRU/95
	100 dia	76	285	209	117	69	63	L40/BRU/96
	100 dia	76	292	215	123	69	75	L40/BRU/97
	100 dia	76	304	209	123	76	88	L40/BRU/98

92.5° Unequal Single Branches with Access

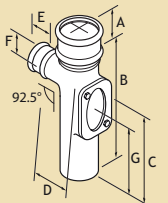
	Pipe Size	A	B	C	D	E	F	G	Product Code
	63 dia	69	260	196	95	63	50	165	L25/BRU/95
	75 dia	69	260	196	100	63	50	165	L30/BRU/95
	75 dia	69	273	206	104	69	63	170	L30/BRU/96
	87 dia	76	266	206	107	63	50	165	L35/BRU/95
	87 dia	76	285	209	111	69	63	176	L35/BRU/96
	87 dia	76	292	215	117	69	75	187	L35/BRU/97
	100 dia	76	279	219	114	63	50	177	L40/BRU/95
	100 dia	76	285	209	117	69	63	180	L40/BRU/96
	100 dia	76	292	215	123	69	75	182	L40/BRU/97
	100 dia	76	304	209	123	76	88	178	L40/BRU/98

Note: When specifying fittings with ears, quote the full product code suffixed with /E.

Harmer LCC Fittings

112.5° Unequal Single Branches

	Pipe Size	A	B	C	D	E	F	Product Code
	63 dia	69	276	187	104	63	50	L25/BRU/115
	75 dia	69	260	174	92	63	50	L30/BRU/115
	75 dia	69	276	187	104	69	63	L30/BRU/116
	87 dia	76	263	180	98	63	50	L35/BRU/115
	87 dia	76	288	184	111	69	76	L35/BRU/117
	100 dia	76	279	190	104	63	50	L35/BRU/115
	100 dia	76	288	184	114	69	76	L40/BRU/117
	100 dia	76	304	193	111	76	88	L40/BRU/118

112.5° Unequal Single Branches with Access

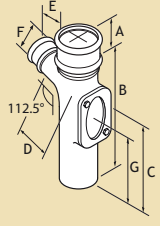
	Pipe Size	A	B	C	D	E	F	G	Product Code
	63 dia	69	276	187	104	63	50	165	L25/BRUA/115
	75 dia	69	260	174	92	63	50	165	L30/BRUA/115
	75 dia	69	276	187	104	69	63	165	L30/BRUA/116
	87 dia	76	263	180	98	63	50	165	L35/BRUA/115
	87 dia	76	288	184	111	69	75	184	L35/BRUA/117
	100 dia	76	279	190	104	63	50	174	L35/BRUA/115
	100 dia	76	288	184	114	69	75	180	L40/BRUA/117
	100 dia	76	304	193	111	76	88	177	L40/BRUA/118

135° Unequal Single Branches

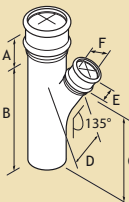
	Pipe Size	A	B	C	D	E	F	Product Code
	63 dia	69	260	130	133	63	50	L25/BRU/135
	75 dia	69	260	130	133	63	50	L30/BRU/135
	75 dia	69	280	130	133	69	63	L30/BRU/136
	87 dia	76	266	133	146	63	50	L35/BRU/135
	87 dia	76	292	133	161	69	75	L35/BRU/137
	100 dia	76	279	139	152	63	50	L35/BRU/135
	100 dia	76	292	127	171	69	75	L40/BRU/137
	100 dia	76	304	127	177	76	88	L40/BRU/138

Note: When specifying fittings with ears, quote the full product code suffixed with /E.

Harmer LCC Fittings

135° Unequal Single Branches with Access

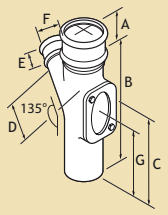
	Pipe Size	A	B	C	D	E	F	G	Product Code
	63 dia	69	260	130	133	63	50	165	L25/BRUA/135
	75 dia	69	260	130	133	63	50	165	L30/BRUA/135
	75 dia	69	280	130	133	69	63	165	L30/BRUA/136
	87 dia	76	266	133	146	63	50	165	L35/BRUA/135
	87 dia	76	292	133	161	69	75	184	L35/BRUA/137
	100 dia	76	279	139	152	63	50	174	L35/BRUA/135
	100 dia	76	292	127	171	69	75	180	L40/BRUA/137
	100 dia	76	304	127	177	76	88	177	L40/BRUA/138

92.5° Equal Double Branches

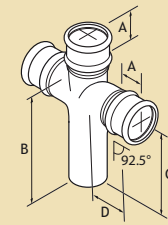
	Pipe Size	A	B	C	D	Product Code
	50 dia	63	234	177	88	L20/BRD/9
	63 dia	69	260	196	95	L25/BRD/9
	75 dia	69	285	212	111	L30/BRD/9
	87 dia	76	304	225	117	L35/BRD/9
	100 dia	76	330	241	130	L40/BRD/9

112.5° Equal Double Branches

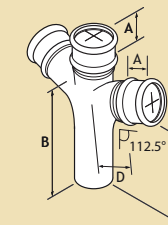
	Pipe Size	A	B	C	D	Product Code
	50 dia	63	234	155	79	L20/BRD/11
	63 dia	69	260	174	85	L25/BRD/11
	75 dia	69	285	184	98	L30/BRD/11
	87 dia	76	304	193	111	L35/BRD/11
	100 dia	76	330	209	120	L40/BRD/11

135° Equal Double Branches

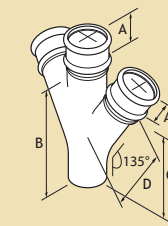
	Pipe Size	A	B	C	D	Product Code
	50 dia	63	234	120	114	L20/BRD/13
	63 dia	69	260	130	130	L25/BRD/13
	75 dia	69	285	136	149	L30/BRD/13
	87 dia	76	304	146	158	L35/BRD/13
	100 dia	76	330	146	184	L40/BRD/13

Note: When specifying fittings with ears, quote the full product code suffixed with /E.

Harmer LCC Fittings

Shoes

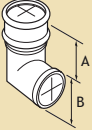
	Pipe Size	A	B	Product Code
	50 dia	63	127	L20/SH
	63 dia	69	149	L25/SH
	75 dia	69	177	L30/SH
	87 dia	76	200	L35/SH
	100 dia	76	228	L40/SH

P Traps

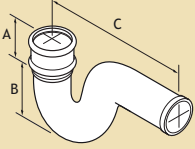
	Pipe Size	A	B	C	Product Code
	50 dia	76	136	343	L40/PT

Pipe Fixings

	Type	Size	Notes	Product Code
	3" Pipe Nail	M8 x 75mm	Bright zinc plated mild steel	NAIL30
	4" Pipe Nail	M8 x 100mm	Bright zinc plated mild steel	NAIL40
	3" Coach Screw	M8 x 75mm	Hardened steel zinc plated	COACH30
	4" Coach Screw	M8 x 100mm	Hardened steel zinc plated	COACH40
	Coach Screw Cap	M8 dia	Black plastic	COACHCAP
	Marine Sealant	310ml Cartridge	Geocel black silicone rubber	MS991563
Caulking Foam 13mm	M13 dia x 10 metre	Polyethylene backer rod	BF991413	

Note: When specifying fittings with ears, quote the full product code suffixed with /E.

Harmer LCC Cast Iron Soil & Waste Systems Supplementary Information

Essential background information to ensure that an appropriate and correct cast iron soil & waste system is installed.

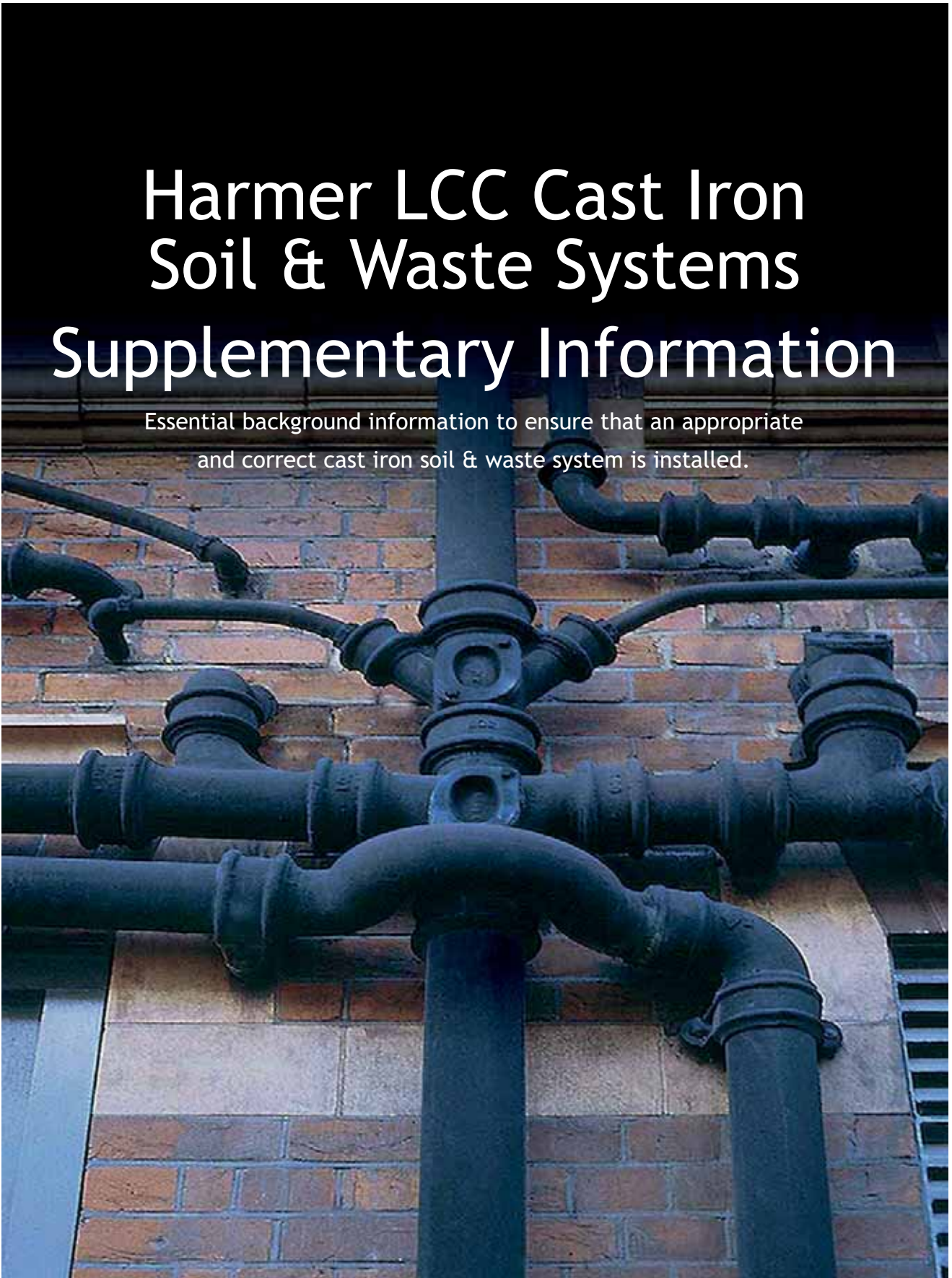

Harmer LCC - Installation

Harmer LCC Traditional Cast Iron Soil & Waste Drainage system has an extensive range of fittings and accessories to provide great flexibility in installation.

The LCC system can be installed using the traditional lead caulking method with the use of a naked flame. Alternatively, Harmer recommends a cold caulking method as described below.

Cold Jointing Method for Harmer LCC Pipes

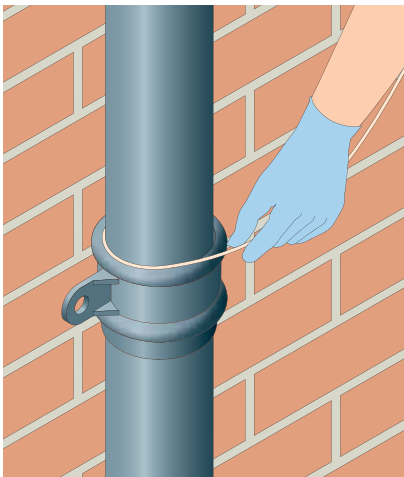

1. Centre the pipe spigot within the socket and insert the caulking foam.

Note: Each joint of a 4" pipe will require approximately 4 metres of caulking foam and a quarter of a tube of black silicone sealant. Estimate usage for smaller or larger diameters on a pro rata basis.

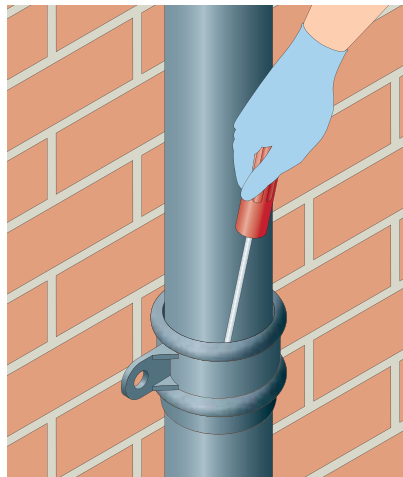

2. Caulk the foam into the socket up to 30mm from the top using a screwdriver. This will centralise the pipes and provide a backing for the sealant.

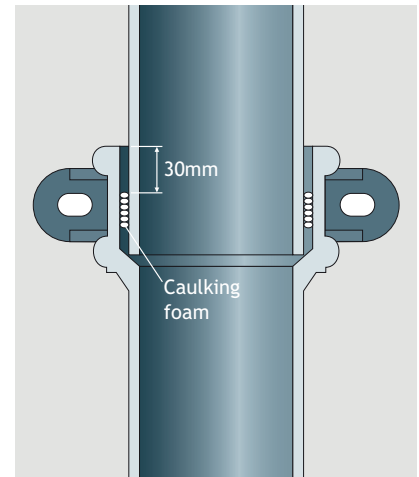

2a. A profile image showing the installed caulking foam in the socket, leaving a 30mm space for the silicone sealant.

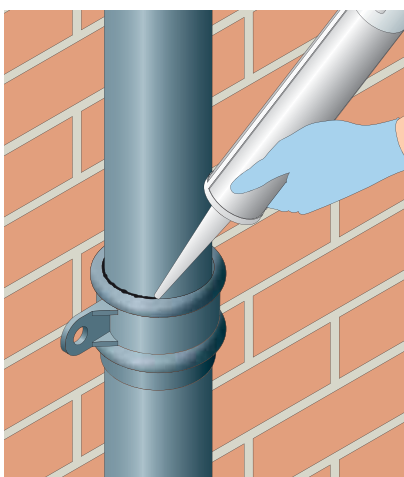

3. Fill the top 30mm with black silicone sealant.

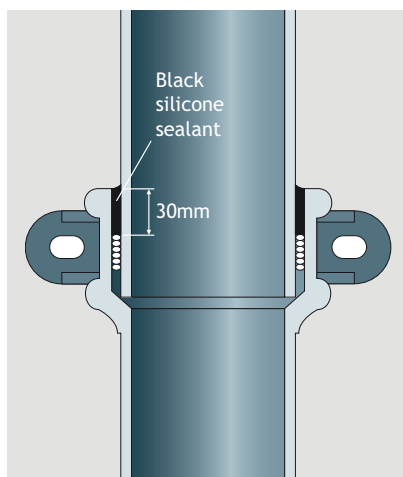

3a. A profile image showing the silicone sealant filling the 30mm gap to the top of the socket.

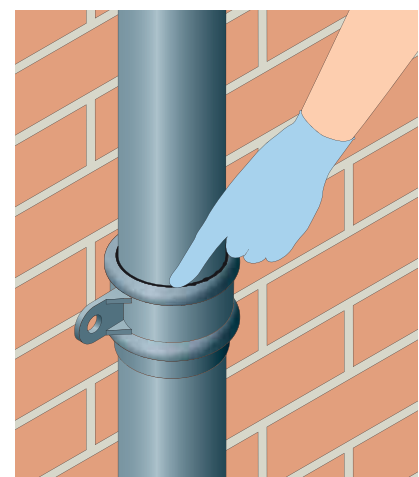

4. When filled, smooth off level with the top of the socket to provide a sealed and neat appearance. No further painting is required if the pipes are black.

Fixing Methods for Harmer LCC Pipes

For eared soil pipes: Use 100mm large head pipe nails, coach screws or other proprietary fixing.

For uneared soil pipes: Use drive-in spikes - alternatively, use holderbats or earbands for a more decorative effect.

All of these types of fixings are available from stock. (See the Price List, sundry items, page 127)

NBS Specification

A typical NBS Specification for Harmer LCC Traditional soil and waste pipes is provided below. A full range of NBS specifications are available via Alumasc's online NBS Specification Builder at www.harmerdrainage.co.uk. For project specific specification advice, contact Alumasc Technical Services.



R11 Above Ground Foul Drainage Systems

GENERAL

- Gravity Foul Drainage System.
- Sanitary and waste pipework, ventilating pipework.

SYSTEM PERFORMANCE

- Design Standard: To BS EN 12056-1:2000, BS EN 12056-2:2000 and National Annexes NA-NG.
- Collection and Distribution of Foul Water: Complete, and without leakage or noise nuisance.
- Design Parameters: Self-cleansing, and without blockage, crossflow, backfall, leakage, odours or noise nuisance. Pipework pressure fluctuations: $\pm 38\text{mm}$ (max). Trap water seal: 25mm (min).

PRODUCTS (TYPICAL SPECIFICATION)

HARMER LCC TRADITIONAL CAST IRON

335 HARMER LCC PIPES

Gutters and fittings to: BS 8530 (formerly BS 2997)
Manufacturer: Alumasc Exterior Building Products Ltd
White House Works, Bold Road, Sutton, St Helens, Merseyside WA9 4JG.
Tel: 01744 648400, Fax: 01744 648401, Email: info@alumasc-exteriors.co.uk

- | | |
|--------------|--|
| Reference: | Harmer LCC cast iron soil and waste system |
| Size: | 76mm (3") diameter |
| Colour: | Black Gloss |
| Joint Type: | Spigot and Socket |
| Fixing: | Fixed to the wall at approximately 1.83m centres through the ears integral to the pipe or via separate galvanised steel holderbats. It is recommended that the fixings be round or dome head galvanised plugged screws with washers. |
| Accessories: | Bends, Branches, Access Pipes, Swan Necks, Plinth Offsets. |



Create Alumasc Rainwater System NBS specifications by selecting the required product range, profile, size and finish by visiting:

www.harmerdrainage.co.uk

Imperial/Metric Conversion Chart

in	mm
$1/8$	3.2
$1/4$	6.4
$3/8$	9.5
$1/2$	12.7
$5/8$	15.9
$3/4$	19.1
$7/8$	22.2

1	25.4
$1 1/8$	28.6
$1 1/4$	31.8
$1 3/8$	34.9
$1 1/2$	38.1
$1 5/8$	41.3
$1 3/4$	44.5
$1 7/8$	47.6

2	50.8
$2 1/8$	54.0
$2 1/4$	57.2
$2 3/8$	60.3
$2 1/2$	63.5
$2 5/8$	66.7
$2 3/4$	69.9
$2 7/8$	73.0

3	76.2
$3 1/8$	79.4
$3 1/4$	82.6
$3 3/8$	85.7
$3 1/2$	88.9
$3 5/8$	92.1
$3 3/4$	95.3
$3 7/8$	98.4

4	101.6
$4 1/8$	104.8
$4 1/4$	108.0
$4 3/8$	111.1
$4 1/2$	114.3
$4 5/8$	117.5
$4 3/4$	120.7
$4 7/8$	123.8

5	127.0
$5 1/8$	130.2
$5 1/4$	133.4
$5 3/8$	136.5
$5 1/2$	139.7
$5 5/8$	142.9
$5 3/4$	146.1
$5 7/8$	149.2

in	mm
6	152.4
$6 1/8$	155.6
$6 1/4$	158.8
$6 3/8$	161.9
$6 1/2$	165.1
$6 5/8$	168.3
$6 3/4$	171.5
$6 7/8$	174.6

7	177.8
$7 1/8$	181.0
$7 1/4$	184.2
$7 3/8$	187.3
$7 1/2$	190.5
$7 5/8$	193.7
$7 3/4$	196.9
$7 7/8$	200.0

8	203.2
$8 1/8$	206.4
$8 1/4$	209.6
$8 3/8$	212.7
$8 1/2$	215.9
$8 5/8$	219.1
$8 3/4$	222.3
$8 7/8$	225.4

9	228.6
$9 1/8$	231.8
$9 1/4$	235.0
$9 3/8$	238.1
$9 1/2$	241.3
$9 5/8$	244.5
$9 3/4$	247.7
$9 7/8$	250.8

10	254.0
$10 1/8$	257.2
$10 1/4$	260.4
$10 3/8$	263.5
$10 1/2$	266.7
$10 5/8$	269.9
$10 3/4$	273.1
$10 7/8$	276.2

11	279.4
$11 1/8$	282.6
$11 1/4$	285.8
$11 3/8$	288.9
$11 1/2$	292.1
$11 5/8$	295.3
$11 3/4$	298.5
$11 7/8$	301.6

in	ft in	mm
12	1 0	304.8
$12 1/8$	1 0 $1/8$	308.0
$12 1/4$	1 0 $1/4$	311.2
$12 3/8$	1 0 $3/8$	314.3
$12 1/2$	1 0 $1/2$	317.5
$12 5/8$	1 0 $5/8$	320.7
$12 3/4$	1 0 $3/4$	323.9
$12 7/8$	1 0 $7/8$	327.0

13	1 0	330.2
$13 1/8$	1 1 $1/8$	333.4
$13 1/4$	1 1 $1/4$	336.6
$13 3/8$	1 1 $3/8$	339.7
$13 1/2$	1 1 $1/2$	342.9
$13 5/8$	1 1 $5/8$	346.1
$13 3/4$	1 1 $3/4$	349.3
$13 7/8$	1 1 $7/8$	352.4

14	1 0	355.6
$14 1/8$	1 2 $1/8$	358.8
$14 1/4$	1 2 $1/4$	362.0
$14 3/8$	1 2 $3/8$	365.1
$14 1/2$	1 2 $1/2$	368.3
$14 5/8$	1 2 $5/8$	371.5
$14 3/4$	1 2 $3/4$	374.7
$14 7/8$	1 2 $7/8$	377.8

15	1 0	381.0
$15 1/8$	1 3 $1/8$	384.2
$15 1/4$	1 3 $1/4$	387.4
$15 3/8$	1 3 $3/8$	390.5
$15 1/2$	1 3 $1/2$	393.7
$15 5/8$	1 3 $5/8$	396.9
$15 3/4$	1 3 $3/4$	400.1
$15 7/8$	1 3 $7/8$	403.2

16	1 0	406.4
$16 1/8$	1 4 $1/8$	409.6
$16 1/4$	1 4 $1/4$	412.8
$16 3/8$	1 4 $3/8$	415.9
$16 1/2$	1 4 $1/2$	419.1
$16 5/8$	1 4 $5/8$	423.3
$16 3/4$	1 4 $3/4$	425.5
$16 7/8$	1 4 $7/8$	428.6

17	1 0	431.8
$17 1/8$	1 5 $1/8$	435.0
$17 1/4$	1 5 $1/4$	438.2
$17 3/8$	1 5 $3/8$	441.3
$17 1/2$	1 5 $1/2$	444.5
$17 5/8$	1 5 $5/8$	448.7
$17 3/4$	1 5 $3/4$	450.9
$17 7/8$	1 5 $7/8$	454.0

Alumasc Rainwater Systems The Steel Range

The NEW lightweight Steel rainwater range provides a contemporary, eco-friendly and cost effective alternative to uPVC gutters.



Steel Rainwater System - Product Summary

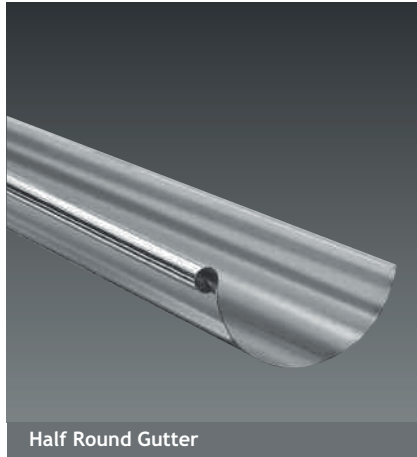

Steel Rainwater System - Product Summary

Alumasc Steel is a lightweight range of contemporary, eco-friendly and cost effective alternative to plastic gutters, without the risk of shrinking, leaking or colour fading. The gutter is available in a choice of four widths in the popular Half Round profile along with a connecting round downpipe system.

Applications

- Ideal for traditional and modern buildings in both new build and refurbishment applications
- A competitive alternative to uPVC systems, with increased flow rates and longevity

Features & Performance

- All gutter widths are deep half round providing maximum flow rates
- Higher flow capacity on outlets due to larger inlet funnels
- Gutter angle is 'deep drawn' and one piece giving greater flow capacity
- Lightweight, durable and non-corrodible
- Quick and easy installation
- Fascia bracket has a larger back plate for installation ease and 6 fixing points compared to 2 on other systems
- Internally seamed downpipe gives a smooth and modern finish
- Downpipe brackets have two concealed vertical fixing points
- Low maintenance

Manufacture

- Manufactured to ISO 9001: 2008
- Manufactured to ISO 14001: 2004

Colours & Finishes

- Available in steel in either a Galvanised or a Black Pre-coated Finish
- Also available to order in 6 other galvanised pre-coated colour finishes upon request
- The system is also available to order in plain zinc or copper
- All colour coated lengths are protected with an adhesive film to prevent damage on-site

Installation & Fixing

- Dry Joint system without the need for additional silicone sealants
- Gutter lengths and angles are jointed with 'EPDM rubber sealed' connectors for fast and watertight installation
- Downpipes and offsets are push fit with 'Swaged' ends, again for fast and watertight installation
- Stop ends are push-fit with 'EPDM rubber sealed' inserts
- Fascia brackets have wide back plates and are multi holed for fast and ultra-secure fascia fixing

Gutter Profile & Sizes



Half Round
100 x 70mm
125 x 80mm
150 x 90mm
190 x 90mm

Pipe Profile & Sizes



80mm
100mm



Steel Gutters and Fittings

Note: All dimensions are in mm unless shown otherwise.

Gutters

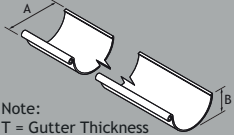
	Gutter Size	Gutter Length	A	B	T	Weight (kg)	Product Code
Note: T = Gutter Thickness (nominal +/- 0.1mm)	100 (4")	3000mm	100	75	0.6	3.24	HRS40/3M
	125 (5")	"	125	80	0.6	3.63	HRS50/3M
	150 (6")	"	150	90	0.6	4.32	HRS60/3M
	190 (7.5")	"	190	100	0.6	5.19	HRS75/3M

Union Connector

	Gutter Size	A	Product Code
	100	45	HRS40/UC
	125	45	HRS50/UC
	150	45	HRS60/UC
	190	45	HRS75/UC

Push-Fit Stop-Ends

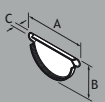
	Gutter Size	A	B	C	Product Code
	100	140	75	10	HRS40/SE
	125	165	85	10	HRS50/SE
	150	190	100	10	HRS60/SE
	190	230	120	10	HRS75/SE

Prefabricated Gutter Outlet

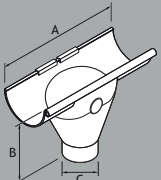
	Gutter Size	Pipe Size	A	B	C	Product Code
	100	80 dia	300	245	75	HRS40/ROA80
	125	80 dia	300	270	75	HRS50/ROA80
	150	100 dia	300	290	95	HRS60/ROA100
	190	100 dia	300	340	95	HRS75/ROA100

Wrap-Around Gutter Outlet

	Gutter Size	Pipe Size	A	B	C	Product Code
	100	80 dia	170	145	75	HRS40/RO80
	125	80 dia	190	160	75	HRS50/RO80
	150	100 dia	200	190	95	HRS60/RO100
	190	100 dia	240	230	95	HRS75/RO100

90° External Angle

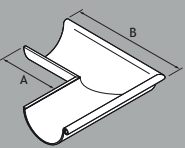
	Gutter Size	A	B	Product Code
	100	160	295	HRS40/EA90
	125	145	300	HRS50/EA90
	150	110	295	HRS60/EA90
	190	125	345	HRS75/EA90

90° Internal Angle

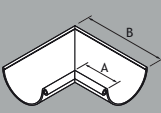
	Gutter Size	A	B	Product Code
	100	160	290	HRS40/IA90
	125	150	300	HRS50/IA90
	150	120	300	HRS60/IA90
	190	120	340	HRS75/IA90

Note: The Steel range is available in a galvanised finish or in a polyester powder coated black finish. Product codes in the tables refer to the galvanised finish. For black painted please add the suffix /BLK. This note also applies to pages 188 and 189.

Steel Gutter Fittings, Pipes and Fittings

Note: All dimensions are in mm unless shown otherwise.

Fascia Bracket

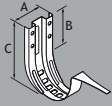
	Gutter Size	A	B	C	Product Code
	100	80	70	135	HRS40/FB
	125	80	70	145	HRS50/FB
	150	80	70	160	HRS60/FB
	190	80	70	210	HRS75/FB

Gutter Rafter Arm

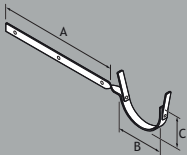
	Gutter Size	A	B	C	Product Code
	100	300	130	205	HRS40/RB/SF
	125	300	130	225	HRS50/RB/SF
	150	300	130	240	HRS60/RB/SF
	190	300	130	255	HRS75/RB/SF

Rise & Fall Bracket

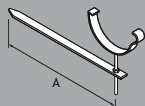
	Gutter Size	A	Product Code
	100	300	HRS40/R&F
	125	300	HRS50/R&F
	150	300	HRS60/R&F

Pipes

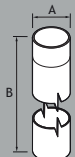
	Pipe Size (A)	Pipe Length (B)	Product Code
	80 dia	3000mm	SRW1/3M
	100 dia	3000mm	SRW2/3M

Downpipe Connector

	Pipe Size	A	Product Code
	80 dia	118	SRW1/DC
	100 dia	117	SRW2/DC

Offset Bend 70°

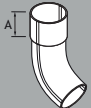
	Pipe Size	A	Product Code
	80 dia	34	SRW1/OSB/70
	100 dia	30	SRW2/OSB/70

Offset Bend 90°

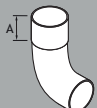
	Pipe Size	A	Product Code
	80 dia	43	SRW1/OSB/90
	100 dia	34	SRW2/OSB/90

Branch 72°

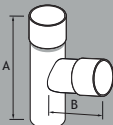
	Pipe Size	A	B	Product Code
	80 dia	280	72	SRW1/BR/72
	100 dia	285	55	SRW1/BR/72

Steel Pipes and Fittings

Note: All dimensions are in mm unless shown otherwise.

Access Pipe

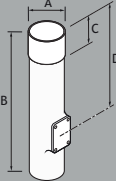
	Pipe Size (A)	B	C	D	Product Code
	80 dia	1000	110	360	SRW1/AP
	100 dia	1000	120	360	SRW2/AP

Rainwater Diverter

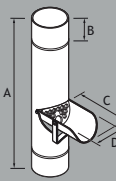
	Pipe Size	A	B	C	D	Product Code
	80 dia	400	57	135	78	SRW1/RDIV
	100 dia	400	53	155	98	SRW2/RDIV

Fixed Offset

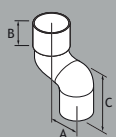
	Pipe Size	A	B	C	Product Code
	80 dia	64	60	160	SRW1/FOS/60
	100 dia	68	60	195	SRW2/FOS/60

Shoe

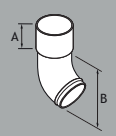
	Pipe Size	A	B	Product Code
	80 dia	36	127	SRW1/SH
	100 dia	29	155	SRW2/SH

Pipe Clip

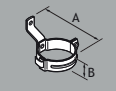
	Pipe Size	A	B	Product Code
	80 dia	120	25	SRW1/PC
	100 dia	135	25	SRW2/PC

Hopper Head (Galvanised)

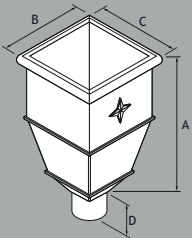
	Pipe Size	A	B	C	D	Product Code
	80 dia	385	220	220	80	SRW1/HH/GS
	100 dia	385	220	220	80	SRW2/HH/GS

Hopper Head (Black Coated)

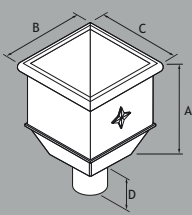
	Pipe Size	A	B	C	D	Product Code
	80 dia	300	230	230	60	SRW1/HH/BCS/BLK
	100 dia	300	230	230	60	SRW2/HH/BCS/BLK

Alumasc Rainwater Systems Steel Range Supplementary Information

Essential background information to ensure that an appropriate and correct steel rainwater system is installed.



Installation - Gutters

Alumasc steel gutters are available in the half round profile in four sizes with a range of brackets to accommodate all types of eaves. The system is dry jointed without the need for additional silicone sealant.

The gutter range can be connected to the steel pipework system and secured by standard pipe clips. The assembly and installation must be considered individually depending on the project, although general aspects of preparation are common to all as shown below.

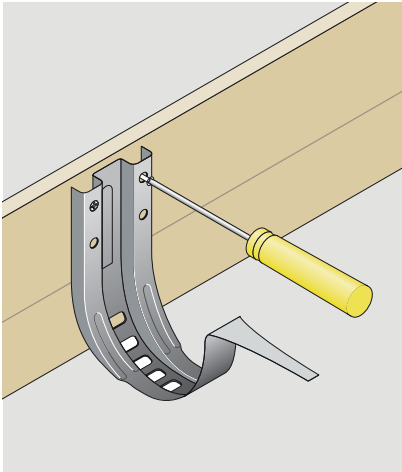

1. Generally position the fascia brackets at 915mm centres, using at least 3 brackets per gutter length. Use 2 screws on both the left and right fixing options and 1/no underneath the gutter securing tab.

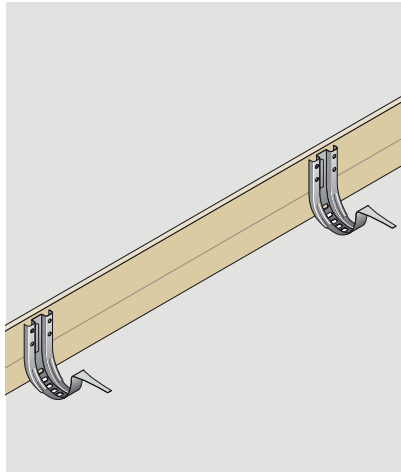

2. Use a string line to set out your fascia brackets along the gutter run allowing for a fall of 1:600 to 1:350 (max).

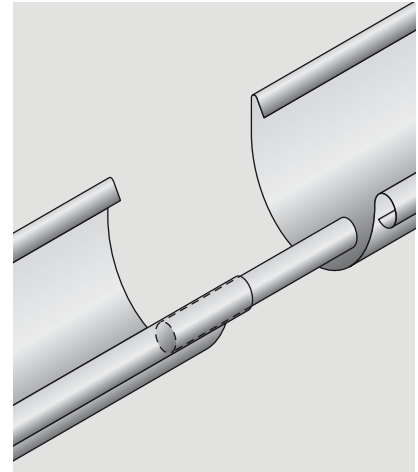

3. A bead connector is used to join two lengths of gutter. Insert the connector into the front roll of each gutter length. Allow for a 4mm expansion gap.

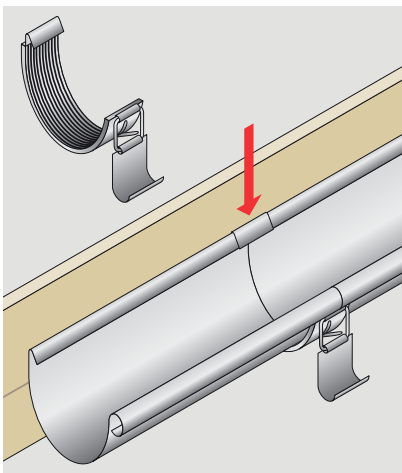

4. An EDPM rubber sealed union connector is used to connect the gutter lengths and angles together. Locate the union connector over the rear edge of the gutter.

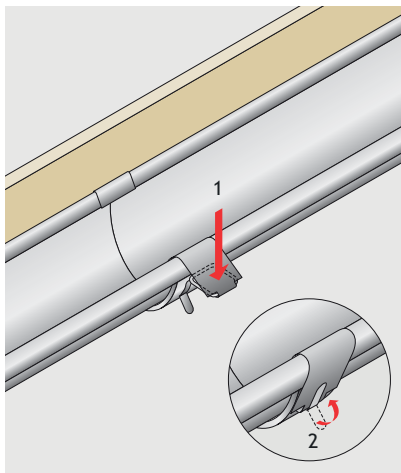

5. Locate the clasp over the front roll edge of the gutter. Push down on top of the clasp and squeeze the clasp shut. Fold the locking tab over to fully secure.

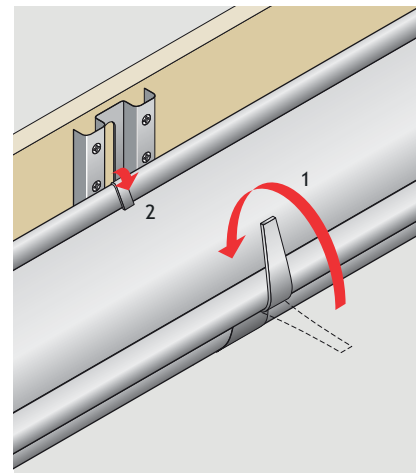

6. Locate the gutter into the fascia bracket and seat level, then fold the front tab of the fascia bracket around the front roll and into the gutter. Fold the rear tab of the fascia bracket down and over the rear edge of the gutter.

For further information or assistance please contact The Rainwater Technical Team on Tel 01744 648400

Installation - Rainwater Pipes

Alumasc steel downpipes are available as a circular profile in 2 sizes with a range of pipe clips and fittings to accommodate all types of installation situations. The downpipes and offsets are push-fit with 'swaged' ends, again for fast and watertight installation.

The assembly and installation must be considered individually depending on the project, although general aspects of preparation are common to all as shown below.

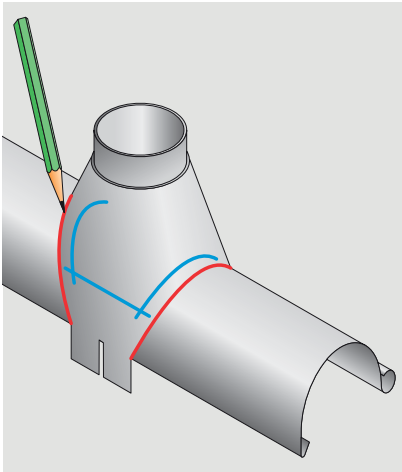

1. When installing a 'wrap around outlet' mark the desired location of the outlet by drawing a line either side of the outlet along its edge. Draw a further line 20mm inside of the outer lines and join these inner lines together in an oval pattern. This becomes the marking for the cut out hole.

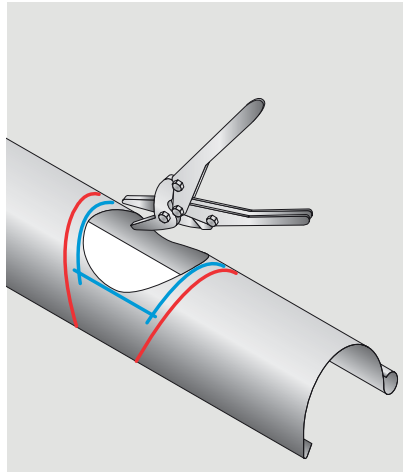

2. Use a hacksaw to make an initial hole in the gutter, and then use a set of tin snips to cut out the inner hole that you have marked out.

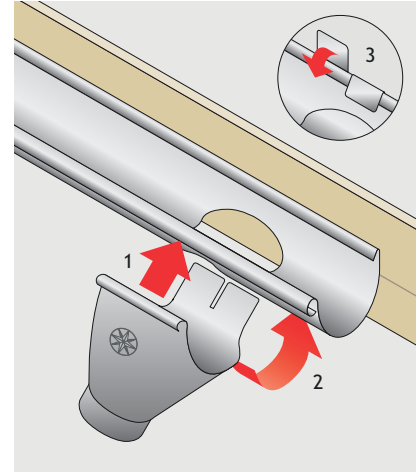

3. Attach the outlet to the gutter and fold the rear tabs of the outlet over the rear edge of the gutter, making sure the outlet is aligned correctly to accept the downpipe.

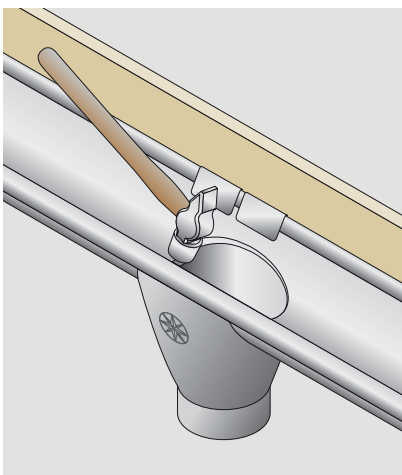

4. Tap the inner rough edges of the hole that was cut in the gutter, down into the outlet, to ensure a smooth flow of water.

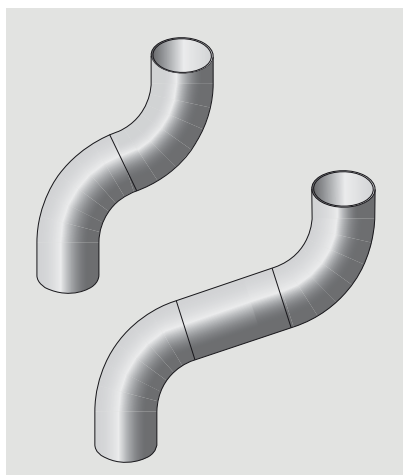

5. Offsets are achieved using 2/no 70° bends, with larger offsets being made by inserting a pipe length between the two bends.

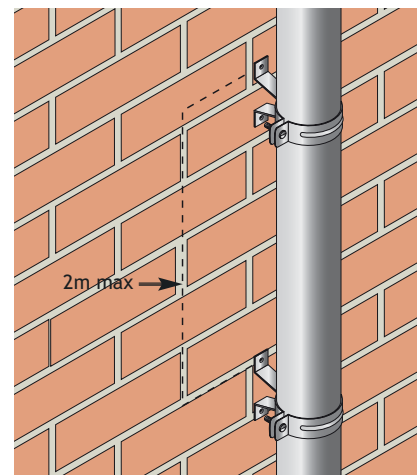

6. Downpipes should be installed using at least 2/no pipe clips per length. Mark out the clips locations and level with a spirit level or plumb line. Open the tightening screw to allow the pipe to be inserted, close the clip and re-tighten, making sure not to over tighten and damage the downpipe.

For further information or assistance please contact The Rainwater Technical Team on Tel 01744 648400

Rainwater System Design

Alumasc Technical Services is a fully experienced team of Rainwater specialists who use the latest CAD technology and calculation tools to provide an unrivalled support service to Architects, Designers and Contractors.

The Alumasc Rainwater Drainage Design Service

Alumasc Technical Services use dedicated design software in conjunction with the requirements of *BS EN 12056:2000: Gravity drainage systems inside buildings - Part 3* to calculate the most appropriate Alumasc rainwater system to suit project requirements.

The gutter flow software automatically checks the capacity of downpipes used and suggests the minimum size to which downpipes can be sized. Contact Alumasc for further information.

Sizing of Gutters and Downpipes

The level of rainfall a given roof drainage system should cope with is based on the position of the gutter, the potential use of the building and its projected lifespan. All true eaves gutters (external) are designed using a 1 year storm event. This is generally accepted because overflow from an external eaves gutter will fall clear of the building, which is not normally a problem. Any gutter which is classed internal, even if it is at the eaves, should be designed for an intensity based on the building life and a suitable factor of safety.

Step 1

Geographical Location and Rainfall Intensity Maps

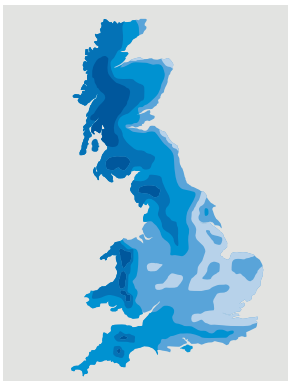

BS EN 12056-3: 2000 contains maps showing rainfall intensity in litres/second per m² for 1, 5, 50 and 500 year storms of 2 minute duration.

(All external gutters designed for 1 year event).

Step 2

Calculating Catchment Area

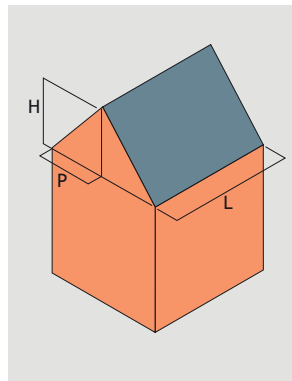

$$CA = (P+H/2) \times L$$

CA = Catchment area in square metres

P = Horizontal distance between eaves and ridge

H = Height of roof

L = Length of eaves

Calculation Criteria

Calculation of the most efficient drainage solution takes into consideration the following criteria:

- Catchment area
- Local rainfall intensity
- Building life and safety factor
- Size and flow rate of gutters
- Frequency and size of outlets and downpipes

This factor will vary from 1.5 for conventional buildings to 4.5 for very important structures. For most buildings a 60 year life and safety factor of 1.5 would be the most suitable (90 year protection life).

All the parameters of flow calculations cannot be captured using a single formula. The guide below provides a basic method for calculating flow requirements. For accurate project specific specification advice on rainwater flow calculations contact Alumasc Technical Services.

Step 3

Frequency and Positioning of Outlets/Downpipes

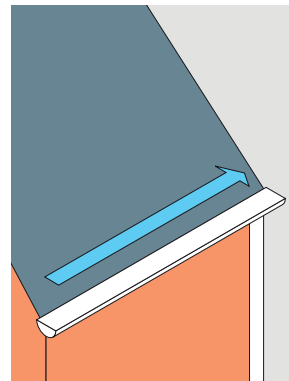

Calculate the number of outlets per run.

Step 4

Calculate Flow Requirements

Overall Rainfall

Catchment Area (CA) x
Rainfall Intensity (RI) =
Overall Rainfall (OR)

Flow Rate Per Outlet

Overall Rainfall (OR) ÷
Number of Outlets =
Flow Rate Per Outlet

Choose Gutter/Outlets
according to published
Flow Rate capacities.

Note:

Depending on building type, a safety factor should be allowed for the sizing of internal gutters. Contact Alumasc Technical Services for further information.



Technical Support

Alumasc's new Drainage Design Calculators are available as a download from the Alumasc Rainwater website.

www.alumascrainwater.co.uk

NBS Specification

A typical NBS Specification for Alumasc steel gutters and downpipes is provided below. A full range of NBS specifications are available via Alumasc's online NBS Specification Builder at www.alumascrainwater.co.uk. For project specific specification advice, contact Alumasc Technical Services.

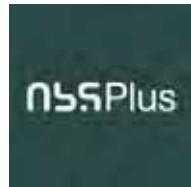

R10 Rainwater Drainage Systems

GENERAL

- Gravity Rainwater Drainage System.
- Rainwater outlets, gutters, pipework and accessories as per detail sections below.

SYSTEM PERFORMANCE

- Design Standard: To BS EN 12056-3:2000, clauses 3-7 and National Annexes.
- Collection and Distribution of Rainwater: Complete, and without leakage or noise nuisance.
- Design Parameters: Design rate of rainfall as per BS EN 12056-3:2000, National Annex NB.2 - Category 1

PRODUCTS (TYPICAL SPECIFICATION)

ALUMASC STEEL HALF ROUND GUTTER (100mm)

311 ALUMASC STEEL GUTTERS

Gutters and fittings to: BS EN 12056-3: 2000
 Manufacturer: Alumasc Exterior Building Products Ltd
 White House Works, Bold Road, Sutton, St Helens, Merseyside WA9 4JG.
 Tel: 01744 648400, Fax: 01744 648401, E-mail: info@alumascrainwater.co.uk

Reference: Alumasc steel rainwater system
 Profile: Half Round
 Size: 100mm
 Outlet Size: 80mm
 Type/grade: Made from Mild Steel
 Finish: Galvanised or polyester powder coated to BS EN 12206-1:2004
 Colour: To be advised

Jointing: External union clips placed over each butt joint and locked with a clip to the front of the gutter.

Fixing: The gutter fixed with bracket fixed at maximum 1000mm centres and at each fitting.

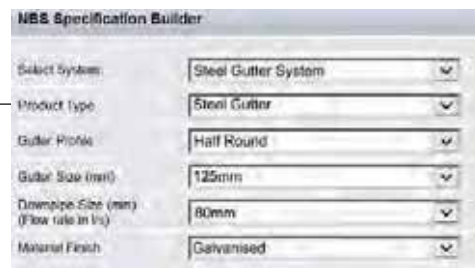

Create Alumasc Rainwater System NBS specifications by selecting the required product range, profile, size and finish by visiting:

www.alumascrainwater.co.uk

PRODUCTS (TYPICAL SPECIFICATION)

ALUMASC STEEL DOWNPIPE (80mm diameter)

370 ALUMASC STEEL PIPEWORK FOR EXTERNAL USE:

Pipes, fittings and accessories to: BS EN 12056-3: 2000
 Manufacturer: As above

Reference: Alumasc steel downpipe system
 Size: 80mm diameter
 Type/grade: Mild Steel
 Finish: Galvanised or polyester powder coated to BS EN 12206-1:2004
 Colour: To be advised

Fixing: Pipe clip fixed at maximum 2.0m centres.
 Plug and screw to wall with number 12 x 50mm round head twin thread screws and washers bright zinc plated to BS 1706:1960 Class.

Accessories: Bends, Branches, Access Pipes, Offsets, Shoes, Rainwater Heads, Pipe Clips.

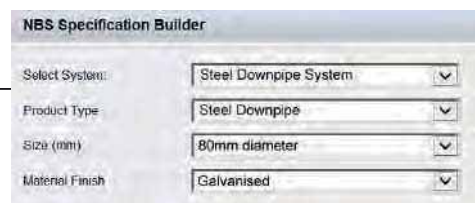

Alumasc Premium Products - All Brands

Alumasc Water Management Solutions (AWMS) is the new name in the industry for proven water management. It's a new joined-up brand that harnesses the expertise of four trusted brands in water management

Alumasc has been promoting the efficient use, retention, recycling and disposal of water within the built environment for over 70 years. Now it combines the knowledge and unique benefits of these four brands to provide one simple solution in water management.



Skyline's high performance weatherproofing and integrated guttering systems provide industry leading rainwater protection.

Skyline includes fascia and soffits, copings, cills and surrounds manufactured from high quality, in-house, BBA certified powder-coated aluminium.



- Fascia
- Soffits
- Copings
- Cills and Surrounds

www.alumascskyline.co.uk



Alumasc is the UK market leader for Aluminium, Cast Iron and Steel gutters and downpipes,

From cutting edge-contemporary to tradition heritage, Alumasc's metal rainwater systems outperform others whatever the weather.



- Aluminium Rainwater Systems
- Cast Iron Rainwater Systems
- Steel Rainwater Systems

www.alumascrainwater.co.uk

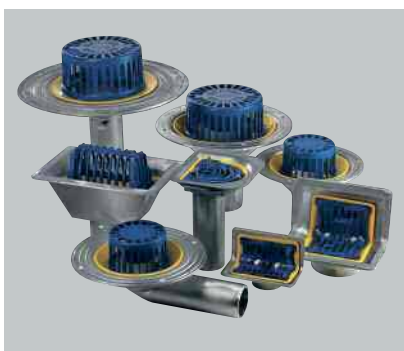

Harmer Building Drainage manages water inside and outside the building.

Its systems allow designers contractors and clients to realise the design performance and installation benefits of fully integrated drainage solutions.



- Roof, Floor and Shower Drains
- Cast Iron Soil and Waste Systems
- Rainwater Management Systems
- Paving and Decking Supports

www.harmerdrainage.co.uk

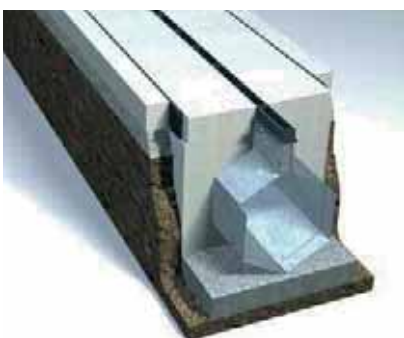

Gatic Civil Drainage specialises in integrated surface water management.

For over 90 years Gatic drainage systems have been used to capture, control and return run-off safely into the natural water cycle.



- Slotdrain
- Filcoten
- Proslot
- Kerb Drainage and Flow Controls

www.gaticdrainage.co.uk

ALUMASC

RAINWATER™

GUTTERS AND DOWNPIPES

Technical Support

+44 (0) 1744 648400

Literature Hotline

+44 (0) 808 100 2008

Website

www.alumascrainwater.co.uk

ALUMASC WATER MANAGEMENT SOLUTIONS

Station Road, Burton Latimer

Kettering, NN15 5JP

United Kingdom

Telephone: +44 (0)1744 648400

Facsimile: +44 (0)1744 648401

Website: www.alumascwms.co.uk

E-mail: info@alumascwms.co.uk

A division of:



All reasonable care has been taken in the preparation of this brochure, all information, recommendations and guidance notes on the use of The Products are made without guarantee since the conditions of use are beyond the control of Alumasc Exterior Building Products Limited (The Company). The customer is responsible for ensuring that each product is fit for its intended purpose and that conditions for use are suitable. The information contained in this brochure and advice arising therefrom is free of charge and accordingly on the terms that no liability nor liability for negligence will attach to the Company or its servants in relation to any such service arising out of or in connection with this brochure. The Company pursues a policy of constant product development and information contained in this publication is therefore subject to change without notice.

1015/2K